

2002 *AURORA*



 Oldsmobile



AS QUICK AND AGILE AS YOU WANT TO BE

5	AGILE
9	STYLISH
13	INTUITIVE
21	ENGINEERING
24	DESIGN
28	INTERIOR
32	SAFETY
36	SPECIFICATIONS

LUXURY COMES WITH CONFIDENCE:

GM Protection Plan

General Motors is backing up every new Oldsmobile Aurora with the confidence of a 5 year/60,000 mile General Motors Protection Plan. Plus continued availability of service and parts.



*Take delivery by 10/01/02. General Motors Protection Plan Major Guard coverage for 5 years/60,000 miles (whichever comes first) effective from the date of delivery and 0 miles. Excludes normal maintenance. Some restrictions apply. See dealer for complete Major Guard details. In Florida, coverage is provided under Oldsmobile 60 month/60,000 mile limited warranty. See Florida dealer for complete limited warranty details.

Aurora 4.0 in Sterling with available chrome wheels.

"This fresh Aurora is a fun-to-drive, remarkably well-executed, sporty sedan..."

Motor Trend - April 2000



Aurora 4.0 in Cappuccino with available chrome wheels.

ON A TWISTY ROAD IT NOURISHES THE SOUL, NOT JUST YOUR EGO.

{AGILE}

Every once in a while, a superbly agile car comes along that makes you feel that, finally, the planets have lined up, the emotional gears have meshed with uncanny precision and your personal tuner has locked into all the right frequencies. Of course, we're talking about the 2002 Aurora. Equipped with the Enhanced Agility System, Aurora is as finely tuned to the human body as your own skin. Which means that when it moves, it also moves you. And when the road turns and twists like a coiled snake, Aurora remains an accomplished charmer.



Aurora 4.0 in Cappuccino.

*“...nicely balances the luxury-comfort
and responsive-agile sides of the driving equation...”*

Motor Trend – April 2000



Aurora 3.5 in Sterling.



WHEN YOU LOOK LIKE THIS, YOU DON'T NEED TO OVERDRESS.

Aurora 4.0 in Sterling with available sunroof.

{STYLISH}

The body is long, lean and taut. There's no grille, so the sweeping lines flow without interruption. The flanks are clean and crisp to highlight the fenders and wheel arches. From the front, its stance is aggressive, looking like it's ready to gobble up the road. From the rear, it looks like it's about to vanish in a blur, shrink to a dot toward the horizon. The first time you see it, you want to touch it. And then, of course, you want to climb in. You find yourself immersed in a perfectly coordinated environment so custom-tailored that you'll wonder how in the world they got your measurements.



"Be still fluttering heart."

USA TODAY - February 2000



Aurora 3.5 in Sterling with available sunroof.

A close-up photograph of a car's center console. The central focus is a gear shifter with a light-colored, possibly cream or beige, leather wrap. The leather has a decorative, raised stitching pattern along its length. The shifter is mounted on a polished metal base, which is set into a center console with a rich, reddish-brown burl walnut wood grain. The surrounding interior panels are a light, neutral color. The lighting is dramatic, highlighting the textures of the leather and wood.

FOR THOSE WHO PREFER ELEGANCE TO GLITTER.

Genuine burl walnut center console with available equipment.



{INTUITIVE}

Imagine if you could demand, and get, impossible service wherever you went. Not just at a resort or on an airline. But everywhere. Aurora does just that. It's intuitive and knows exactly what you want, when you want it. Wherever you go, you're surrounded by rich leather trim and burl walnut. The Aurora 4.0 driver's seat remembers your most comfortable position. The available heated front seats warm you on demand. Even the tires tell you when they're not properly inflated. And the world's best music is a fingertip away. Could someone possibly live like this? The question is, why would you want to live any other way?

Available Bose® Premium Sound System.

“Trimmed in real burlled walnut and real leather . . . the interior will make the passengers feel comfortable, even pampered.”

thecarconnection.com – February 2000



Aurora 3.5 interior in Neutral with Dark Neutral Accents. Shown with available Navigation Radio and other optional equipment.



Aurora 3.5 interior in Neutral with Dark Neutral Accents. Shown with available equipment.



Aurora 4.0 in Cappuccino

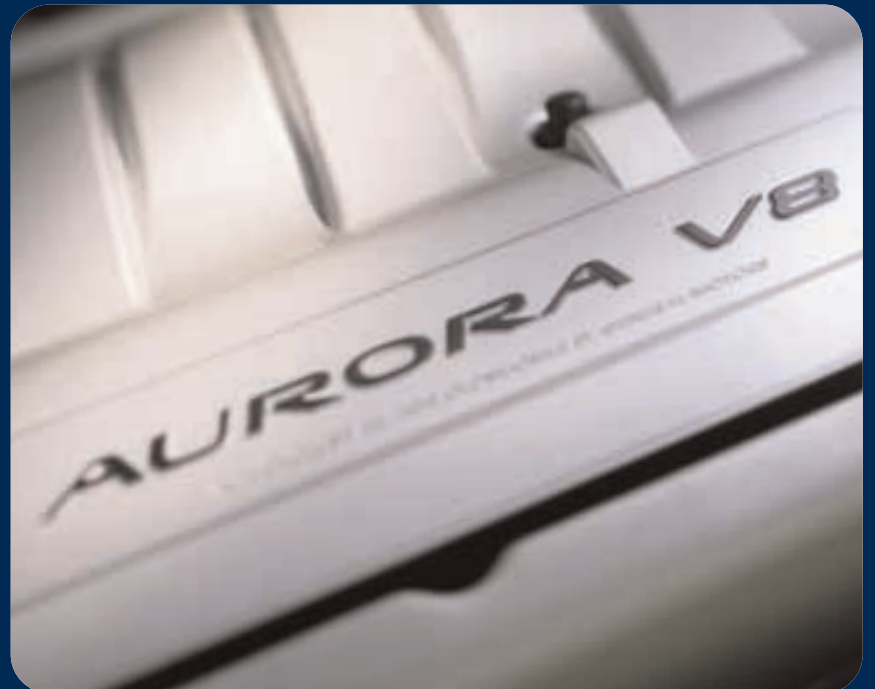

OBSESSIVELY CRAFTED TO PROVOKE AN EMOTIONAL RESPONSE.

21 ENGINEERING

24 DESIGN

28 INTERIOR

32 SAFETY

36 SPECIFICATIONS

{ENGINEERING}

Hairpins. S-curves. An ever-tightening corner that curls like a corkscrew. You can look at them as annoying interruptions to the straight and narrow. Or golden opportunities to let Aurora do what it does best. Turn the wheel, apply the brakes and feel every inch of the car cooperating to get you through these asphalt variations with added confidence. Aurora thrives on curves, with agility and confidence evident with every twist of the road.

HOW WOULD YOU LIKE YOUR CURVE SERVED?

Aurora and you have the Enhanced Agility System to thank for all this. This system is an array of 19 interrelated features and components that respond instantly to the driver's input. With it, you've got the road tools to read the pavement and to help you feel like you're connected to every atom of the asphalt. How would you like your road served? With this system, you'll call it well done and come back for seconds.

← Clockwise • Front coil-over shock • 4.0 V8 engine • Tachometer • 3.5 V6 engine

{PRECISION CONTROL SYSTEM}

The Precision Control System (PCS), standard in 4.0 and available in 3.5, helps you prevent loss of control when you encounter an unexpected road hazard. This system enhances safety by working with Aurora's inherently balanced performance, monitoring steering angle, turning rate and lateral acceleration (g's), then modulating one or more brakes when needed to help Aurora track the driver's intended path. When cornering on a slippery road surface, for instance, PCS can selectively apply either of the two front brakes to counteract a front- or rear-end slide. It's also helpful when sudden steering is required; for example, to avoid an obstacle. This system works automatically to help you stay in control in a wide range of conditions.

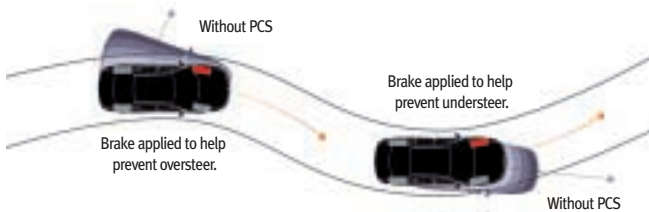

PRECISION CONTROL SYSTEM

The components of the Precision Control System are linked together by means of an encoded multiplexed communication system. The information stream is updated hundreds of times per second and responds to changing traction conditions.

{ENHANCED AGILITY SYSTEM}

The Enhanced Agility System is an array of 19 components and subsystems working in concert to provide instant response to the driver's input. These features have been seamlessly integrated into one of the most satisfying driving systems currently available.



SMOOTH RIDE, SHARP HANDLING

To help you keep an even keel over bumps or make a quick direction change, the **variable strut-valving system** [1] firmly controls up and down motion for a smooth ride and enhanced precision.

STRONG, STABLE BRAKING

Powerful **4-wheel disc brakes** [2] and the **antilock braking system (ABS)** [3] provide quick, stable deceleration to help the driver maintain steering and directional control under braking.



⚡ SLICK, PRECISE SHIFTING

Gear selection becomes second nature, thanks to the **gated shifter** [4], and there's no longer a need for a lock-out button so there's never second-guessing.



⚡ FAST RESPONSE TO THE ROAD

Aurora features an **all-independent 4-wheel suspension** [5] system for a smoother ride and great handling. The suspension also features **lightweight aluminum components** [6] and **aluminum alloy wheels** [7] to reduce unsprung weight. This translates into accurate response to bumps as well as impressive handling.

A HARD BODY HELPS MAKE HANDLING EASY

Aurora's **rigid chassis** [5] and **hydroformed suspension cradles** [6] help resist body flex to facilitate precise suspension movement and promote quick response to steering.

PLUGGED IN

The **easy-to-reach controls** [20] and the **bolstered seat** [21] plug the driver directly into Aurora's central nervous system. They make the driver a crucial part of the ride and handling loop.

HARDWIRED TO THE ROAD

Because the steering is the key way of keeping you in touch with the road, Aurora has **rack-and-pinion steering**, with the advanced **Magnasteer power assist system** [22] and a **rigid magnesium steering column support** [23] to better communicate between the pavement and the driver.

POWERFUL, RESPONSIVE ENGINES

Equipped with a **center-feed induction system** [24] for quick response to throttle, **roller cam followers** [25] for reduced friction and **high swirl combustion chambers** [26] for better breathing, either engine has ample reserves of power always at the ready.

NO WASTED ENERGY

The electronically controlled **4-speed automatic transmission** [27] is finely calibrated to select the right gear under a variety of operating conditions. Shifting is quick, smooth and precise.

NO SQUIRM EQUALS IMPRESSIVE RESPONSE

Low profile tires [28] have more rigid sidewalls to reduce tread squirm. This means faster, more precise response to steering. **Optimized caster setting** [29] yields excellent straight-line stability and quick turn-in on curves.

3.5-LITER TWIN CAM V6

The 3.5-liter V6 produces 215 hp at 5600 rpm and 230 lb-ft of torque at 4400 rpm. The dual overhead camshaft design promotes quick response to throttle input. So when you call for a quick burst of passing power, the engine gets right on the job.

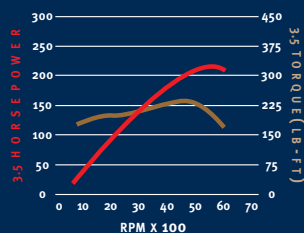

4.0-LITER DOHC V8

The 4.0-liter V8 produces 250 hp at 5600 rpm and 260 lb-ft of torque at 4400 rpm. Like the V6, this engine also features a DOHC design. And its broad flat torque curve helps to provide responsive power over a wide range of engine speeds.

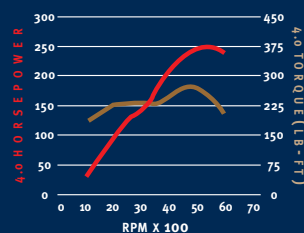

{DESIGN}

With Aurora, every elegant line and body stamping not only looks good, but it's been obsessively designed to work very hard. The door openings, for instance, are large to give you a bit of extra space getting in and out of the cabin. The center high-mounted stoplamp is large and mounted high to enhance visibility. The roof pillars and rockers are designed to optimize interior space. The rigidity of the side structural members and

IT'S SO YOU, IT MAKES YOU JEALOUS OF YOURSELF.



lower-side floorpan members helps to provide excellent collision protection and to keep out road noise and vibration. And to help you and your passengers enjoy that added space, Aurora has one of the most elaborate and effective sound insulation systems on the market. Which means your passengers won't need to raise their voices when they say, "Nice car."

Clockwise • Integrated taillamps • Sculpted fenders • Halogen headlamps • Chrome wheel* ❧

*Available on 4.0.



SEALED FOR YOUR COMFORT

In the testing phase, air was pumped into the interior under pressure to check for effectiveness of weather seals. It led to the development of thick, robust seals.

WARM AND DRY IN A BAD STORM

To make sure bad weather stays out, Aurora was subjected to a water torture test that sprayed 1,000 gallons of water in eight minutes at high pressure.

REACTS BEFORE YOU DO

The available rain-sensing wiper system automatically activates the wipers at the first sign of raindrops on the windshield to help you get a jump on a sudden downpour.



FOLDING SIDE MIRRORS

The power outside mirrors have a foldaway design to prevent damage. The standard heated feature helps de-ice on a cold morning.



16-INCH ALLOY WHEELS

The Aurora 3.5 is equipped with 16-inch alloy wheels with an open spoke design to provide plenty of air for better brake cooling.



17-INCH ALLOY WHEELS

The Aurora 4.0 features standard 17-inch alloy wheels. They reduce unsprung weight for impressive handling and response.

FEWER HOLES FOR A QUIETER CABIN

The air-conditioning module has been relocated to the interior, just under the dash, to reduce the number of holes for the ducts in the bulkhead. Fewer holes mean less noise intrusion into the cabin.

TOUGH BARRIER AGAINST NOISE

Sound intrusion from the engine and the road is effectively silenced by an elaborate, five-layer bulkhead design. There are two steel layers and three layers of sound blockers.

IT DOESN'T SHOUT; IT WHISPERS

No stone was left unturned to achieve Aurora's sound-damping targets. Even the blades of the engine-cooling fan were carefully shaped to make as little noise and turbulence as possible. The fan speed is also variable to help provide just the right amount of air for ambient conditions, so it doesn't run unnecessarily and consume precious energy.



GOLD PACKAGE

While not necessarily functional, the gold package adds a certain elegance. Offered as an option on Aurora 4.0 and 3.5 models, the gold package includes gold finish on the hood emblem and the rear panel script.

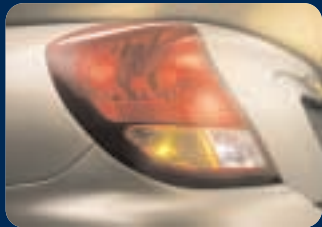

INTEGRATED TAILLAMPS

The large, integrated taillamps have a liquid crystal look and are molded to wrap around the decklid. The outer lens is free of optics for a cleaner, more dramatic look.

NOISE SUPPRESSION

A total of 22 sound blockers are installed in hollow cavities throughout the body. The blocks of material expand to fill the cavity from the heat generated in the paint baking process to better seal out noise.

BANISH ROAD RUMBLE

Aurora uses a multilayer, sound-absorbing carpet system. It consists of a thick synthetic layer and a thick foam shield molded to the contours of the floorpan.



SUNGLASSES FOR THE WHOLE CAR

Aurora is designed to help the interior stay cool in sunlight. The Solar Ray glass helps to block out radiant heat to help the climate control system work more efficiently. Another bonus of this glass is that it helps reduce fading of interior surfaces by blocking out ultraviolet rays.

PREVENTS RUST BY STAYING DRY

To help keep moisture from infiltrating the body and to block out noise from rain splatter, Aurora uses thick vinyl rain deflectors behind each door's trim panel.

REDUCE DRY-CLEANING BILLS

Carefully designed rain gutters blend into the body for a clean look. They also help keep you drier when stepping out of the Aurora in the rain.

{INTERIOR}

By now, you should be sufficiently impressed with Aurora's superbly sound-insulated interior. But what is there to appreciate amidst all that silence? A lot. Standard leather seating surfaces, for one, complemented by genuine burlled walnut accents. You'll also find a standard automatic climate-control system that lets you set a desired temperature, which the system then holds regardless of weather changes. And the air isn't just cooled or heated. It's also filtered. A replaceable micron filter is designed to help screen pollen and dust and keep you more comfortable. To keep you entertained, Aurora features a standard AM/FM stereo and CD/cassette player

RELAX. WE'VE GOT YOU COMPLETELY SURROUNDED.

with six speakers or an available Bose® Premium Sound System. Once you listen to the amazing audio quality, you'll know why we were so over-the-top obsessive about creating such a quiet cabin. Aurora also features an available Navigation Radio. This CD-based system uses global positioning to pinpoint your location at any time. It comes with a detailed CD database of your region.* As well as a CD covering the general usage area of the continental United States. It's so advanced, it will give you automated turn-by-turn voice directions. It even knows if you've made a wrong turn, automatically.

Clockwise • Convenient armrest controls • Walnut accents • Analog instruments ⇄**

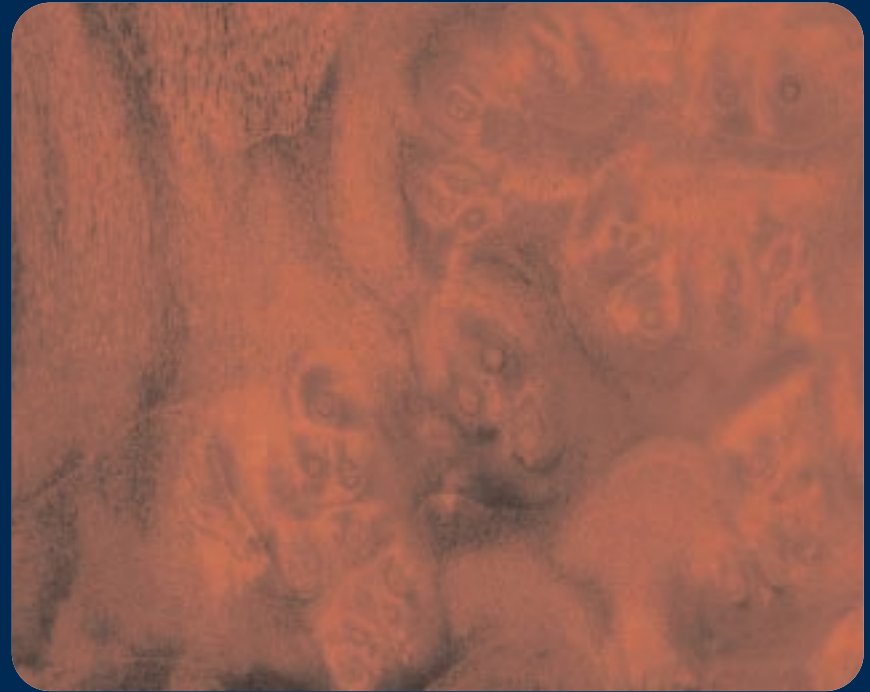



DRIVER INFORMATION CENTER

The standard Driver Information Center is a constant source of data. It provides information such as fuel range, battery condition, oil pressure, tire pressure and even engine oil and transmission fluid life index. It also alerts you with 27 different warning functions.



OVERHEAD CONSOLE

The overhead console houses courtesy lamps, a storage area and available sunroof controls. The Aurora 4.0 features a universal garage door opener.

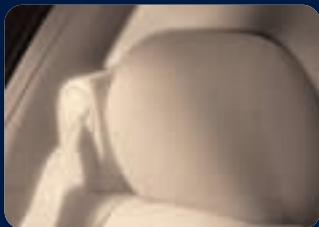

SEAT-MOUNTED SAFETY BELTS

Front seat safety belts are mounted to, and move with, the seats for enhanced comfort.

THEY'LL SEE YOU SOONER

After turning on the front foglamps, you have the choice of also activating the rear foglamps. They help to make you more visible in low-visibility conditions.

ROOM FOR LONG CARGO

If you need to carry skis or anything too long for the trunk, the standard rear-seat pass-through can easily handle them.



USER-FRIENDLY TRUNK

Not only does the spacious trunk hold a lot of gear and luggage, but the thick carpeting helps protect it from hard use. For convenience, the standard cargo net helps secure small or fragile objects, and a low liftover height makes it easy to load and unload cargo or luggage.

ACOUSTICALLY TAILORED FOR AURORA

The available Bose® Premium Sound System features an AM/FM tuner and CD/cassette player. It was tuned specifically for Aurora's interior. A 12-disc CD changer is also available.

TOTAL RECALL

The keyless entry personalization feature provides two keyfobs, allowing each driver to select separate settings. Upon pressing the entry button, the system activates your radio presets, sets the temperature, and, if equipped with the available memory feature, adjusts the power driver's seat to your preference.

TAILORED COMFORT

Aurora has a standard leather-trimmed 8-way power adjustable driver's seat with power lumbar adjustment. The 4.0 adds a driver's seat memory feature and an 8-way power front passenger's seat with power lumbar adjustment.

CONTINUITY OF POWER

The retained accessory power feature lets you operate the power windows and radio for ten minutes after the ignition is switched off or until you open a door.

UNLIMITED FRESH AIR

The available power sunroof is the perfect way to enjoy a sunny day or a warm evening. The sliding sunshade blocks out the sun on a hot day to keep you cool.



CONTROL YOUR ENVIRONMENT

With Aurora, you set the desired temperature, and the system takes care of the rest. The Aurora 4.0 has standard dual-zone climate control.

THE BETTER TO SEE AND BE SEEN

The automatic headlamp control system senses ambient light conditions and switches on the headlamps as dusk approaches to help make you more visible and improve your safety.

ON THE ROAD CONVENIENCE

For convenience on the road, Aurora is equipped with a center console with an armrest, storage for a cell phone, two auxiliary power outlets and two cupholders.

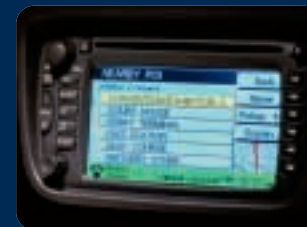

NAVIGATION RADIO

The available Navigation Radio pinpoints your location at any time. A comprehensive database provides addresses and directions to thousands of businesses and attractions.*



STEERING WHEEL TOUCH CONTROLS

You can adjust the audio volume or the temperature setting without lifting a hand from the wheel, thanks to the standard steering wheel touch controls.



HEATED SEATS

For the ultimate in comfort on a chilly morning, Aurora features available heated front seats that let you select the right setting for the conditions.

*Limited detailed coverage area.

{SAFETY}

Aurora's occupant safety is a multilayered system of interconnected technologies that work to help enhance protection. Basically, Aurora is designed to help you avoid a collision and to help reduce the risk of injury in the event a collision is unavoidable. The available Precision Control System is one example of Aurora's crash-avoidance technology. Also helping to avoid a collision are the ABS system, the traction control system (available in 3.5

OCCUPANT PROTECTION AND SECURITY FOR ADDED PEACE OF MIND.

and standard in 4.0) and the responsive steering and suspension. To help protect you in a moderate to severe frontal collision, Aurora features dual front air bags*. Driver and front passenger side-impact air bags help reduce the risk of injury in a severe side collision. The front and rear crumple zones and the rigid cabin structure also help reduce the risk of injury and add to your peace of mind.

Clockwise • Remote keyless entry system • Standard OnStar service ***
• Disc brake rotor • Rear foglamps



The OnStar* service, standard on Aurora, is designed to enhance your security while on the road. In the U.S. and Canada, wherever a cellular connection can be made, OnStar can pinpoint your location and automatically alert an OnStar Advisor in case of an emergency. For instance, OnStar can sense the deployment of the air bag and alert the Advisor, who will contact help and provide them your location.

Aurora features safety systems such as rear foglamps and a large center high-mounted stoplamp to help make you more visible to vehicles behind you and standard daytime running lamps to help make you more visible to oncoming traffic. Other safety- and security-related features include heated side mirrors, rear child-seat upper tether anchors to help secure child seats, battery rundown protection, available Electrochromic mirror that automatically blocks glare, and a system that locks the doors when you shift out of park.

*One-year OnStar safety and security contract is standard on Aurora. OnStar uses existing emergency service providers and cellular and satellite technologies. Call 1-800-ONSTAR-7 for system limitations and details, or visit www.OnStar.com.



Aurora 4.0 in White Diamond with available chrome wheels.

STANDARD FEATURES (3.5 & 4.0)

Powertrain/Chassis and Suspension

- 3.5-liter DOHC V6 engine with sequential fuel injection • 4-speed electronic-shift transaxle with automatic overdrive • Stainless steel dual exhaust system • Unitized body structure • Independent strut front suspension with coil springs • Independent semi-trailing arm rear suspension with cast aluminum arms, lateral links and coil springs • Front and rear stabilizer bars • 4-wheel disc brakes • Magnasteer variable-assist power rack-and-pinion steering • 16-inch aluminum alloy wheels with Goodyear® P225/60R16H performance tires
- [Standard features on 4.0](#) • 4.0-liter DOHC V8 engine with sequential fuel injection • 17-inch aluminum alloy wheels with Michelin® P235/55R17H performance tires • All-speed traction control • Precision Control System

Safety and Security

- OnStar* • Dual frontal air bags and front-seat side-impact air bags**
- 3-point seat-mounted front safety belts • Rear outboard and center 3-point safety belts • Rear child-seat upper tether anchors • 4-wheel antilock brakes • Brake/transmission shift interlock • Rear child-security door locks • PASS-Key vehicle security system • Daytime running lamps • Headlamps with flash-to-pass feature • Battery rundown protection • Driver-controlled power window lockout • Tire pressure monitor • Pulse-type windshield wipers/washer • LED rear center high-mounted stoplamp • Front and rear foglamps • Self-aligning front head restraints

Driver Controls

- Full instrumentation • Gated console-mounted shifter • TILT-Wheel adjustment • Cruise control • Power trunk and fuel filler releases • Back-lit switches

Seating and Trim

- Contour front bucket seats with manually adjustable head restraints
- Driver-side 8-way power seat with power lumbar adjustment • Rear bench seat with integrated headrests, center fold-down armrest and trunk pass-through • Burled walnut center console and door trim
- Leather-trimmed seating areas • Leather-wrapped steering wheel
- Leather-wrapped shift knob • Storage: front overhead console with courtesy lamps and compartment for garage door opener; center console with storage compartment, cupholders, coin holder; glovebox; front seatback pockets; door map pockets • Passenger assist handles • Driver and front passenger sun visors with supplementary extensions and map straps • Front and rear floor mats
- [Standard features on 4.0](#) • Rear-seat storage armrest with cupholders
- 8-way power front passenger seat with power lumbar adjustment

Comfort and Convenience

- Automatic climate control • Outside temperature display • Cabin air filtration system with replaceable cartridge • Driver information system

- with multifunction digital readout • Power windows with driver/passenger auto-down • Remote keyless entry system with programmable power door locks and personalization features • Steering wheel touch controls
- Illuminated entry/exit package • Front and rear reading lamps • Heated, power outside folding mirrors • Dual illuminated vanity mirrors
- Automatic headlamp control • Auxiliary power outlets • Retained accessory power • Trunk cargo net
- [Standard features on 4.0](#) • Automatic dual-zone climate control with rear seat heating/cooling • Driver seat and outside mirrors memory feature
- Universal garage door opener • Auto-dimming Electrochromic rearview mirror with compass • Additional personalization features

Audio System

- AM/FM stereo and CD/cassette player • 6-speaker Dimensional Sound audio system • Diversity antenna system

Exterior

- Halogen headlamps with projector-type low beams • Solar Ray tinted glass
- Body-color side moldings and door handles • Chrome-tipped exhaust outlets
- [Standard features on 4.0](#) • Automatic moisture-sensitive windshield wipers

Enhanced Agility System

The Enhanced Agility System, standard in both Aurora models, consists of an array of 19 features and systems designed to respond instantly to the driver's demands.

1. Variable strut-valving system
2. 4-wheel disc brakes
3. Antilock braking system (ABS)
4. Gated console-mounted shifter
5. Rigid chassis
6. Hydroformed suspension cradles
7. All-independent 4-wheel suspension
8. Lightweight aluminum suspension components
9. Aluminum alloy wheels
10. Easy-to-reach controls
11. Bolstered seats
12. Magnasteer variable-assist power rack-and-pinion steering
13. Magnesium steering column support
14. Center-feed induction system
15. Roller cam followers
16. High swirl combustion chambers
17. 4-speed electronic-shift transaxle with automatic overdrive
18. Low-profile tires
19. Optimized caster settings

AVAILABLE FEATURES (3.5 & 4.0)

Powertrain/Mechanical

- Engine block heater

Comfort and Convenience

- Power sunroof with gray tinted glass and sliding sunshade (includes universal garage door opener)
- Heated driver and front passenger seats (Passenger Comfort Package required on 3.5)

Audio System

For the 3.5, these features require one of the following: Passenger Comfort Package, All-Weather Package or Convenience Package.

- Navigation Radio (requires 12-disc CD changer.)
- Bose Premium Sound System with 8 speakers
- 12-disc CD changer

Exterior

- White Diamond premium exterior color • 16-inch 6-spoke chrome-plated alloy wheels[†] • 17-inch 6-spoke chrome-plated alloy wheels^{††}

AVAILABLE PACKAGES

The Passenger Comfort, All-weather and Convenience Packages are standard on 4.0 and available on 3.5. The Gold Graphics Package is available on both models.

Passenger Comfort Package

- 8-way power front passenger seat with power lumbar adjustment • Rear storage armrest with cupholders • Automatic dual-zone climate control

All-Weather Package

- All-speed traction control • Precision Control System (Passenger Comfort Package required)

Convenience Package

- Driver seat and outside mirrors memory feature
- Automatic moisture-sensitive windshield wipers
- Auto-dimming Electrochromic rearview mirror with compass • Universal garage door opener

Gold Graphics Package

- Gold finish on hood emblem and rear panel script

SPECIFICATIONS

Powertrain

	3.5	4.0
Engine displacement	3.5 liter (212 cu. in.) DOHC V6	4.0 liter (244 cu. in.) DOHC V8
Horsepower	215 @ 5600	250 @ 5600
Torque (lb-ft)	230 @ 4400	260 @ 4400
Fuel injection	Sequential	Sequential
Transmission	4-speed automatic	4-speed automatic
Transaxle ratio	3.29	3.71

Interior Dimensions

Headroom front/rear (in.)	38.6/37.7	38.6/37.7
Legroom front/rear (in.)	42.5/38.0	42.5/38.0
Shoulder room front/rear (in.)	58.9/58.4	58.9/58.4
Hiproom front/rear (in.)	55.4/56.1	55.4/56.1

Capacities

Passengers	5	5
Fuel tank (gals.)	18.5	17.5
Trunk capacity (cu. ft.)	14.9	14.9

Exterior Dimensions

Wheelbase (in.)	112.2	112.2
Overall length (in.)	199.3	199.3
Width (in.)	72.9	72.9
Height (in.)	56.7	56.7
Curb weight (lb.)	3686	3803
Tread width front/rear (in.)	62.3/62.3	62.3/62.3
Tire size	P225/60R16	P235/55R17
Wheel size	7.0 x 16	7.5 x 17
Turning diameter (ft.)	39.5	40.0

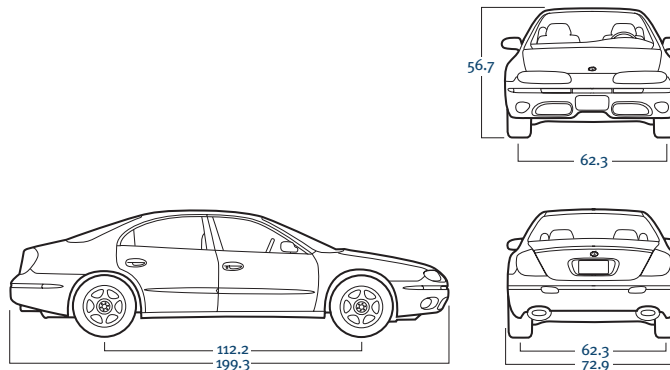

*One-year safety and security contract is standard on Aurora. OnStar services require vehicle electrical system and wireless service to be available and operating for features to function properly. Call 1-800-ONSTAR-7 or visit www.OnStar.com for system limitations and details. **Always use safety belts and proper child restraints, even with air bags. Children are safer when properly secured in a rear seat. See the Owner's Manual for more safety information. †For 3.5 only. ††For 4.0 only.

EXTERIOR COLORS/INTERIOR COLOR AVAILABILITY



CAPPUCCINO
Neutral with Dark Neutral Accents
Dark Gray

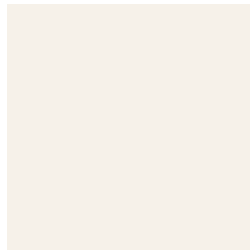

IVORY WHITE
Neutral with Dark Neutral Accents
Mocha
Dark Gray



MARINE BLUE
Neutral with Dark Neutral Accents
Mocha
Dark Gray

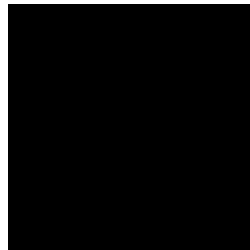

BLACK ONYX
Neutral with Dark Neutral Accents
Mocha
Dark Gray



CHERRY
Neutral with Dark Neutral Accents
Mocha
Dark Gray



GRANITE
Neutral with Dark Neutral Accents
Mocha
Dark Gray

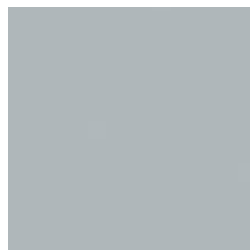

STERLING
Neutral with Dark Neutral Accents
Dark Gray



POLO GREEN
Neutral with Dark Neutral Accents
Mocha
Dark Gray

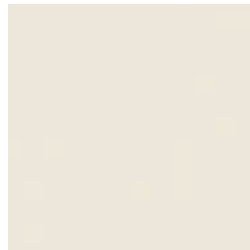

WHITE DIAMOND*
Neutral with Dark Neutral Accents
Mocha
Dark Gray
*Extra charge

INTERIOR COLORS



NEUTRAL WITH DARK NEUTRAL ACCENTS



MOCHA



DARK GRAY

Upper portion represents accent trim.
Lower portion represents seat color.

All exterior colors are metallic except Ivory White and Black Onyx. The paint color samples shown here may vary slightly from actual vehicle color due to the printing process.

A WORD ABOUT OLDSMOBILE

The Occupant Protection, Crash Avoidance and Security/Theft Deterrence sections below contain a partial listing of Aurora safety features. See your dealer for complete details.

USE YOUR GM CARD

What are you charging toward? When you use The GM Card, you receive 5% of every credit card purchase in GM Card Earnings* which can save you hundreds, even thousands toward the purchase or lease of a new Aurora or any GM car, truck or SUV (excluding Saturn, Saab, and EV1 unless subject to a special promotion). To apply for your GM Card, call 1-800-8GM-CARD 24 hours a day. Or visit us online at gmcards.com.

*See The GM Card Program Rules that are applicable to your Account for terms, conditions and limitations (either The GM Card Earnings Program Rules, which have a \$500 annual Earnings cap, or The GM Card Earnings and Redemption Allowance Program Rules, which have Earnings redemption limits).

SMARTLEASE BY GMAC

SmartLease lets qualified customers pay for the expected depreciation of the vehicle over a period of time, plus a rent charge, taxes and fees, rather than paying for the entire vehicle as you would with traditional financing. This typically means with SmartLease you'll be able to drive a new vehicle every few years or drive a better-equipped model. Ask your Oldsmobile dealer for more information or call 1-800-32-SMART.

ACCELERATE YOUR COLLEGE SAVINGS

Upromise is a revolutionary college savings accelerator that can help you save thousands of dollars for college. Through Upromise, America's most trusted companies contribute a portion of your everyday spending into a college savings account for your children, grandchildren or any other child you wish to support. For complete details on the GM-Upromise program, go to <http://upromise.gm.com>. Enrollment is simple and absolutely free.

FOR OCCUPANT PROTECTION

• Adjustable front and rear (outboard) shoulder belt guides • Driver and front passenger air bags • Front side-impact air bags • Automatic door locks • Safety belt cinch capability for child seats • Rear child-security door locks • Power window lockout • Self-aligning front head restraints • Child restraint upper tether anchors

A NOTE ON CHILD SAFETY

Always use safety belts and proper child restraints, even with air bags. Children are safer when properly secured in a rear seat. Never place a rear-facing infant restraint in the front seat of any vehicle equipped with an active air bag. See your vehicle Owner's Manual and child safety seat instructions for more safety information.

FOR CRASH AVOIDANCE

• 4-wheel antilock brakes • Brake/transmission shift interlock • Front and rear disc brakes • Disc brakes audible wear indicator • Maintenance-free battery • Tires with built-in tread wear indicators • Automatic daytime running lamps • Foglamps • Door warning lights • Halogen headlamps • Remote power heated outside rearview mirrors • Rear window defogger • Front side-window defoggers • Tinted glass windshield • Automatic exterior lamp control • Cornering lamps • Steering wheel touch controls

FOR SECURITY/THEFT DETERRENCE

• Anti-lockout feature • Battery rundown protection • Laser-etched VIN plate • PASS-Key vehicle theft-deterrent system • Remote deck and hood releases • Remote-control keyless entry system • Audible theft-deterrent system

A WORD ABOUT THIS CATALOG

We have tried to make this catalog comprehensive and factual. We reserve the right, however, to make changes at any time, without notice, in prices, colors, materials, equipment specifications, models and availability. Since information may have been updated since the time of printing, please check with your Oldsmobile dealer for complete details. Oldsmobile reserves the right to lengthen or shorten the model year for any product for any reason, or to start and end model years at different times.

THE GM MOBILITY PROGRAM

Oldsmobile recognizes the importance of mobility to everyone's life and, therefore, offers financial assistance to persons with disabilities through the General Motors Mobility Program. This program can provide up to \$1,000 reimbursement toward the cost of eligible aftermarket adaptive equipment for drivers and passengers. For details and free resource information, call 1.800.323.9935 (TTY users: 1.800.833.9935).

ASSEMBLY

Oldsmobiles and their components are assembled or produced by different operating units of General Motors, its subsidiaries or suppliers to GM Worldwide. We sometimes find it necessary to produce Oldsmobiles with different or differently sourced components than originally scheduled. Since some options may be unavailable when your vehicle is assembled, we suggest that you verify that your vehicle includes the equipment you ordered or, if there are changes, that they are acceptable to you.

ENGINES

Oldsmobiles are equipped with engines produced by different operating units of GM, its subsidiaries or suppliers to GM Worldwide.

UPDATED SERVICE INFORMATION

Oldsmobile dealers receive useful service bulletins about Oldsmobile products. You can order them by calling 1.800.551.4123.

BUMPER-TO-BUMPER LIMITED WARRANTY

For three years or 36,000 miles (whichever comes first), every part of your new Aurora is warranteed for repairs to correct any vehicle defect related to materials or workmanship, including tires. With this limited warranty, there's no deductible, which means we'll pay for any repairs beyond normal maintenance. All body sheet metal components are warranteed against rust-through from corrosion for six years or 100,000 miles, whichever comes first. There is also no deductible for rust-through repairs. Application of additional rust-inhibiting materials is not required or recommended. See your Oldsmobile dealer for the terms of this limited warranty.

OWNER AFTERCARE

Throughout our three-year/36,000-mile (whichever comes first) Bumper-to-Bumper Limited Warranty, we also offer Courtesy Transportation, free trip routing and 24-hour Roadside Assistance by calling 1.800.442.OLDS. At Oldsmobile, we're committed to your satisfaction long after the purchase of your car.

GM PROTECTION PLAN 5 YEAR/60,000 MILE General Motors Protection Plan

General Motors is backing up every new Oldsmobile Aurora with the confidence of a 5 year/60,000 mile General Motors Protection Plan, which also includes roadside assistance and courtesy transportation. Take delivery by 10/01/02. General Motors Protection Plan Major Guard coverage for 5 years/60,000 miles (whichever comes first) effective from the date of delivery and 0 miles. Excludes normal maintenance. Some restrictions apply. See dealer for complete Major Guard details. In Florida, coverage is provided under Oldsmobile 60 month/60,000 mile limited warranty. See Florida dealer for complete limited warranty details.

NEED MORE INFORMATION?

Visit our Web site at www.auroracar.com, or call toll-free 1-877-GET-AURORA. For information on any other Oldsmobile product, visit us at www.oldsmobile.com or call 1-800-255-6537.

 © 2001 GM Corp. All Rights Reserved. Printed in the U.S.A. 8/01. Alero, Bravada, Intrigue, Silhouette, Delco, GMAC, GM Protection Plan, General Motors Protection Plan Major Guard, Major Guard, The GM Card, Oldsmobile, the Oldsmobile emblem, the Oldsmobile nameplate, SmartLease and the Aurora logo are registered trademarks of General Motors Corp. General Motors Protection Plan is a service mark of General Motors Corp. Magnasteer and TILT-Wheel are trademarks of Delphi Automotive Systems. PASS-Key is a registered trademark of Delco Electronics Corp. OnStar and the OnStar emblem are trademarks of OnStar Corp. "Aurora" is used with permission of Hankook Tire. Printed on recyclable paper. ♻



Silhouette

Bravada

Intrigue

Aurora

Alero