



# OLDSMOBILE 1988



THE TENTH DECADE  
VOL. II

CUTLASS CALAIS • CUTLASS CIERA • CUTLASS CRUISER • CUTLASS SUPREME CLASSIC • FIRENZA • FIRENZA CRUISER

**NINETY YEARS AGO, A CAR COMPANY WAS FOUNDED UPON THE PRINCIPLE OF OFFERING THE CUSTOMER VEHICLES OF SUBSTANTIAL QUALITY AND VALUE...**

What we do and how we do it goes back to our very beginning in 1897, when the board of directors of the Olds Motor Works established this principle: "...to build one motor car in as nearly perfect a manner as possible." □ Are they

still built like they used to be? The answer is both yes. And no. □ Over the past 90

years, the machinists who built the early Oldsmobile models did so virtually by hand, and the production methods were crude at best. But the goal, then as now, was to build a quality car that every Olds owner could be proud of. □ Today, the people who design and build Oldsmobiles are products of the finest universities in the world and have at their disposal the latest and finest in computers and advanced electronics. □ The tools have changed. Our principle hasn't.

□ Through the years, Oldsmobile's continuing search for excellence has led to the development of numerous innovations that have not only changed

Oldsmobiles, but changed the face of the industry itself. Here are just a few such important advancements from Oldsmobile... & The Curved Dash Runabout at the turn of the century, with single-cylinder, 4-cycle engine. It enjoyed

such universal acclaim, it became the first automobile to become the subject of a popular song—"In My Merry Oldsmobile." & With the introduction of the first fully automatic Hydra-matic Drive transmission, Oldsmobile virtually revolutionized how the world drives. New convenience and driving ease for the ever-growing driving public. & With Oldsmobile's introduction of its first high-compression V8, the Performance

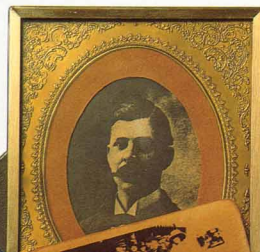

Age was born! The V8-powered Olds 88 became the first of a record seven



Oldsmobiles to set the pace at Indy—and became a racing legend by capturing the

highly-sought-after NASCAR Grand National Championship—three consecutive years! & Oldsmobile has broken the styling mold, too. Remember the *four-door* hardtop? That was Oldsmobile's Holiday Sedan. And, of course, there was Oldsmobile's Vista-Cruiser, the first station wagon with a vista-view roof. & Also introduced by Oldsmobile—Olds Toronado, *Motor Trend* magazine's "Car of the Year" and the first contemporary personal luxury car with front-wheel drive. Today, of course, front-wheel drive is the rule. & For 1988, Oldsmobile features Quad

4, the revolutionary new 4-cylinder, 16-valve, dual overhead cam engine that powered the Olds Aerotech research vehicle (shown on the next page) in high-speed testing. The new Quad 4 engine will be available in Olds Cutlass Calais. It could well become the *next* engineering legend. □ And so it goes at Oldsmobile, as it has for

the past 90 years. Doing it first. Doing it better. Offering the engineering innovations that make driving an Oldsmobile easier, more convenient, more comfortable and a downright pleasure. □ And doing it right. Demanding a level of quality and dependability so



exacting, the Oldsmobile owner is assured lasting value, tangible value—over the miles—and the years.

**NOTHING'S CHANGED.**



To you, our valued customer: If you could see what I have seen happening in the design studios, in the engineering groups, in the offices and plants, you would see what I see in the 1988 Oldsmobiles now available for your purchase at your Oldsmobile dealer. It's quality... quality of a very special kind. It's Oldsmobile Quality. It began from the pride and commitment of one man, Ransom E. Olds, 90 years ago and is reconfirmed today by the thousands of people who build, sell and service Oldsmobile automobiles. It exists because we guard and value our reputation, your enjoyment, your respect. And so, in 1988, it gives me especially great pleasure and pride to invite you, whether it is for your first or 91st time, to read about, test drive and purchase a new Oldsmobile and enjoy the many pleasures and advantages of Oldsmobile Quality.

Thank you.  
*William W. Lane*

William W. Lane  
Vice President, General Motors Corporation  
General Manager, Oldsmobile Division





**1988 OLDSMOBILE. FROM METALS THAT RESIST RUST... TO A WARRANTY THAT WON'T LET YOU DOWN.**

From Oldsmobile—some of the best-built and most corrosion-resistant Oldsmobiles that we've ever offered. And that excellence runs deep. It starts with metals that fight rust. Like galvanized steel and zincrometal. Each is used extensively throughout Oldsmobile bodies—from doors to hood to trunk lid and rocker panels. On some models, all exterior metal from the windows down is galvanized on both sides.

Nearly the entire body is immersed in a bath of rust-resistant primers, forming a tough, protective skin.

Nooks and crannies are treated with special hot waxes and zinc-rich primers for additional protection. Then the body is painted—with coat upon coat of lustrous enamel.

The anti-corrosion protection is so thorough and so effective that every 1988 Oldsmobile is backed with a new warranty that includes 6-year/100,000-mile rust-through protection\* And the quality doesn't stop there. In fact,



engine, transmission and axle quality and dependability have reached such a level that every 1988 Oldsmobile is backed with a 6-year/60,000-mile powertrain warranty\* When you turn the key, the only surprises are pleasant ones.

\*See your Oldsmobile dealer for the terms and conditions of this limited warranty.

**FROM OLDS INTERNATIONAL SERIES TO AN ELECTRONIC "OIL CHANGE REMINDER," THERE'S A LOT THAT'S NEW IN EVERY 1988 OLDSMOBILE.**

Throughout the 1988 Oldsmobile literature, you will be reading about all that's new. But here is a quick sampling of the year's highlights.

**New Oldsmobile International Series!**

Brand-new! And it's available in Olds Cutlass Ciera and new Cutlass Calais. The International Series features a European look, a special bucket seat interior and a sporty feel of the road.

Available in coupe or sedan, each is powered by a premium performance, fuel-injected engine—with 4-speed automatic over-drive transmission in Ciera and 5-speed manual in Calais. The suspension is Oldsmobile's sophisticated Level III (FE3) system. This special firm ride and handling package includes new performance



tires for outstanding traction— even on wet or snowy road surfaces.

If you love to drive, you've got to test drive the new Olds International Series Ciera and Calais!

**Facts at your fingertips!**

With an available Driver Information System, pertinent facts are always at your fingertips.

This auto calculator instantly tells you your current MPG, ETA, driving range on remain-



ing fuel, miles to destination and more.

It even tells you when your oil is due for a change! When only 10% of the oil life remains, a reminder appears once a day which reads "CHANGE OIL IN (NUMBER) MILES." When the oil has been changed, simply reset the system with the push of a button.

This system is especially important because oil-change intervals vary with each individual car, depending on individual driving habits and climatic conditions.

User-friendly, this auto calculator has large button graphics. Minimum driver input is required. Try it. It's easy and informative. Available in Cutlass Calais, Cutlass Ciera, Delta 88 and Ninety-Eight with specific fuel-injected engines.



**Anti-lock braking for smooth, controlled stops in a virtually any situation.** You're cruising along a rain-slicked freeway, the traffic heavy and moving fast. Suddenly the driver in front of you slams on his brakes. Do you panic? Not with advanced ABS—the Teves electronic anti-lock braking system.

A sensor at each wheel constantly monitors the speed of that wheel and feeds the data to a microprocessor. Hit the brakes in an emergency situation, and the microprocessor assists by sending commands to apply brake pressure up to 15 times per second to make

corrections and to provide stable, lock-up-free stopping power when you need it most. Anti-lock braking is standard on Olds Touring Sedan and available on Toronado Trofeo, Toronado, Ninety-Eight and Delta 88 models.

**New in-car storage convenience.**

Available in Cutlass Ciera, Delta 88 and Ninety-Eight—a new storage armrest that's just right for your car phone, cassette tapes or personal belongings. Helps keep your interior neat and clean.



**Now new utility for a sporty, sophisticated Olds.**

That's Olds Cutlass Calais, SL and International Series, with their new split-folding rear seat—with open cargo area to the trunk. Fold down the split seat back, and you can carry skis or golf clubs, as well as a rear seat passenger. Or fold down the entire seat back and carry even larger totes or toys.

**New 3-way power sunroof for Ciera.**

It's a sunroof. It's a refreshing vent. It's a shaded roof. It's your choice—with Cutlass Ciera Sedan's new available 3-way power sunroof. Just pick the mode that suits your mood.

**New driver-side inflatable restraint.**

Available on Olds Delta 88 Sedan models for 1988. The specially designed steering wheel has a new, compact, inflatable restraint (airbag) system built in. The adjustable Tilt-Away feature is also included.

**New looks, new lights for Firenza.**

For 1988, Olds Firenza features a stylish new grille and aerodynamically smooth composite headlamps. High beams are

halogen lamps for excellent down-the-road viewing. Firenza also features larger tires for impressive ride and handling.



**New 3-point safety belts for rear seat passengers.**

They are as comfortable and easy-to-use as front seat belt systems. Simply bring the belt across your lap and "click." You're belted—with both shoulder and lap restraints. Standard on all Olds Delta 88 and Toronado models. The belts store neatly against the seat when not in use.



**New convenience when ordering options!**

Options that have proven to be especially popular have now been grouped into convenient new option packages.

This makes ordering simpler. And in some cases, more affordable—based on comparison of manufacturer's suggested retail price of option package versus options if purchased separately. See your salesperson for details.

**Customer satisfaction—sale after sale.**

Customer satisfaction is never automatic. You have to work at it. And we do. In fact, every Oldsmobile dealer is an active participant in Oldsmobile's Par Excellence Customer Satisfaction Commitment Program to provide quality service and sales professionalism. Is it working? According to you, our customers, the answer is a resounding YES!

**OLDSMOBILE TOURING SEDAN: THE DRIVING EXPERIENCE FOR EXPERIENCED DRIVERS.**

With the new 3.8 SFI 3800 V6 engine, sophisticated Level III (FE3) suspension and leather in the seating areas, Touring Sedan

is Oldsmobile quality in its most magnificent form. A special Oldsmobile Touring Sedan brochure is available.

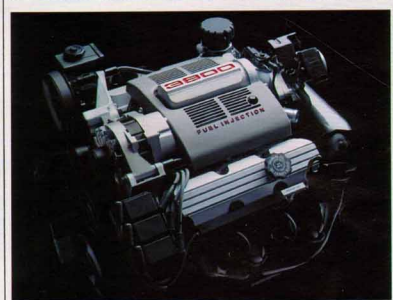

**NEW 3.8 SFI 3800 V6 PROVIDES PREMIUM PERFORMANCE FOR DELTA 88, NINETY-EIGHT AND TORONADO!**

Oldsmobile introduces the new 3800 sequential port fuel-injected V6 engine! Lightweight metals and state-of-the-art technology make it an impressive balance of power and smoothness. Standard in Ninety-Eight and Toronado and optional at no extra cost in Delta 88, the new 3800 V6 features special lightweight pistons, to help provide smooth running performance.

Performance is further enhanced by the tuned intake manifolds and large diameter exhaust "take down" pipes. The results: low back pressure and impressive performance.

Fuel is injected directly into each intake port by a high-

pressure turbine pump at exactly the right time and with exactly the right fuel/air mixture—at every speed. Each injector is sequentially activated with new state-of-the-art crankcase sensor technology.

By signaling the engine every microsecond (about 84 times a second), the engine responds with optimum performance, smooth operation and minimized exhaust emissions.

The new 3800 sequential port fuel-injected V6. It's one great engine. Go enjoy one great test drive!

But that's just a part of the big engine news from Oldsmobile for 1988. Turn the page, and learn about the exciting new Quad 4 engine, available in Olds Cutlass Calais!



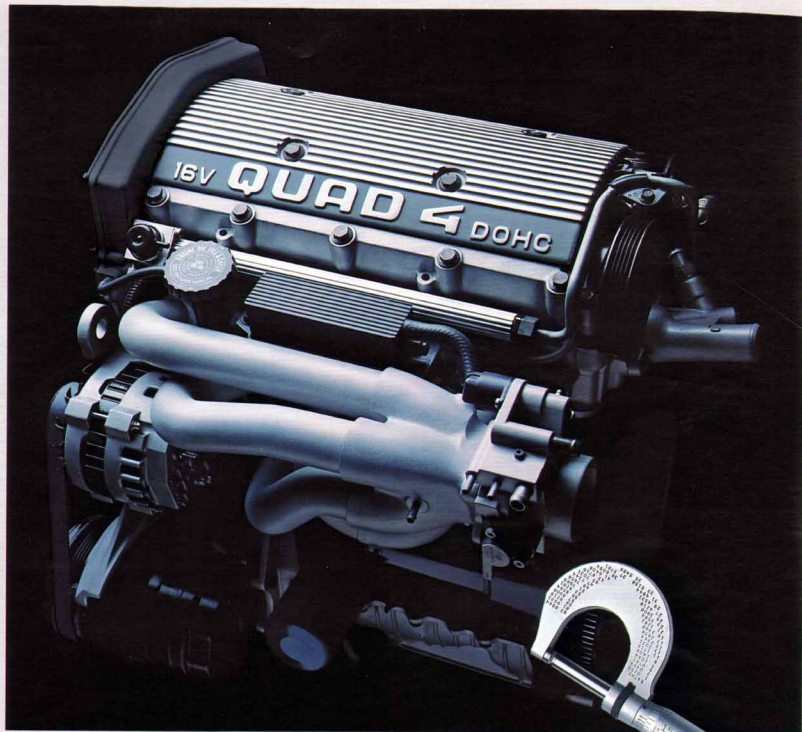

**FROM A BLANK SHEET OF PAPER TO ONE OF THE FINEST ENGINES OFFERED BY GENERAL MOTORS.**

A big part of the Oldsmobile commitment to quality is a commitment to the future. To new and innovative products like the Quad 4 engine—a 2.3-liter, 4-cylin-

der, dual overhead cam, 16-valve engine developed to deliver remarkably high horsepower for its displacement. But the future is coming at you faster than you think, because Quad 4 is available in Oldsmobile Cutlass Calais models after November 1, 1987.

Now, what started as a blank sheet of paper is a revolutionary new engine that incorporates the most modern technologies in the

industry today. The Quad 4 is designed to provide world-class quality, reliability and durability. It delivers smooth, dependable and truly outstanding performance. But Oldsmobile



Oldsmobile Aerotech research vehicle

wanted still more. Hence, the Oldsmobile Aerotech—an exclusively designed research vehicle developed and built for the express purpose of testing the Quad 4 engine and putting it through some of the toughest paces ever known. The Quad 4 and the Oldsmobile quality—in impressive form.

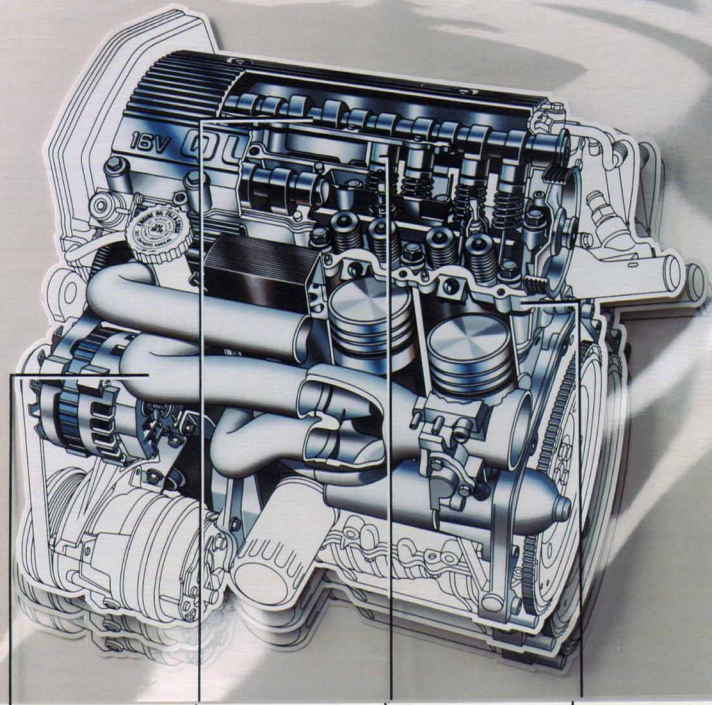

*High-flow/high-velocity intake and exhaust ports are alcohol resistant for increased durability. Manifolds are newly engineered and highly tuned for optimum output and minimum displacement. The result is remarkably high horsepower in relation to engine displacement. Quad 4 doesn't need to work as hard to deliver more power than conventional engines.*

*The Quad 4 incorporates an efficient overhead cam configuration. Engine components including the camshaft, cam carriers and cam carrier covers are tooled in-plant. Computer-precise statistical and quality control is maintained in conjunction with actual assembly.*

*A "simultaneous double fire" multipoint fuel injection system is combined with an integrated direct ignition system. No distributor or secondary spark plug wires are used, and hydraulic valve lifters are also minimum mechanical/direct acting, without the use of a rocker arm. The complexity of the engine is reduced.*

*The crossflow coolant designed 16-valve cylinder head is made of cast aluminum alloy. Coolant distribution around the cylinder bores is insured by three machined apertures within each passage. Coolant passes through a tubular manifold system for optimum distribution and complete temperature control.*

**BEHIND EVERY OLDSMOBILE INTERIOR, THERE ARE THOUSANDS OF PEOPLE WORKING TO MAKE SURE THE BEST SEATS IN THE HOUSE ARE ON THE ROAD.**

Mechanically, more design and engineering expertise go into the construction of an Oldsmobile's seats than in the seating for most any other application in life.

Examples of Olds four seating configurations, and a detailed inside look at their design technology are shown below.

Each seating style shares a common Oldsmobile trait...the purpose to help you feel at one with your Oldsmobile, ease your drive and support

you proportionately with no points of noticeable pressure. The interior is also designed to complement the attitude and road handling attributes of the Oldsmobile of which it is a part.

Yet, where your Oldsmobile outshines even a sumptuous living room or high-tech airline seating is this... the trend-setting design-excellence of Oldsmobile interior fabrics, color and trims.

It is this combination of color, textiles, fabrics, woods and vinyls that gives you the feeling that you are in a totally coordinated, well-thought-out environment, designed and built to last.

This reflects the demanding Oldsmobile standards that are reached for every time a new Olds interior is created or a new fabric is chosen.

For instance: Each year, stylists, designers and engineers look at well over 1,000 fabric samples from the top textile mills in the country.

Of those, six, seven, maybe ten will be good enough to make it into your new Oldsmobile. Good enough looking. Good enough wearing. Correct in statement and purpose, with all the color, style and strength characteristics we believe are essential to being good enough for an Oldsmobile.

Color, texture and weave are totally analyzed for the design statement they create. Is it elegance (light pinstripes, pin-dotted velours and herringbone grays)? Or sportiness (light on dark horizontal stripes and earth-tone colors and larger plaids)?

And what about wearability and

durability? The inside of a parked automobile can reach temperatures as high as 275°F or as low as 50°F below zero.

So the fabric and materials used in Oldsmobiles are put into an oven, subjected to precisely measured sunlight and ultraviolet rays in the lab and on location in Florida and Arizona, and then chilled to well below zero.

Before and after, they twist. They bend. They crumple and they rend. And they do it time and time again to push the limits of fabric technology. The sewing thread is subjected to even more rigid testing.

The result is to simulate the wear and tear a car will endure over a five- to ten-year period. The goal, with normal use and care, is to retain a

like-new look for five years. No thread-baring, rips or tears for ten.

Oldsmobile leathers have also reached levels of sophistication comparable to fabric technology. New chromium-tanning techniques, as well as the application of polymer coatings, have achieved leather upholstery that is durable, yet soft and supple with good moisture absorption characteristics.

Colors are chosen for their ability to blend and harmonize over 100 or more different materials. The benchmark is called the polypropylene standard...a five-inch square against which all other materials will be color-compared under all sorts of lighting, with spectrographs, computer devices and the most color-sensitive instrument of all, the human eye.

Even the shine of each material's surface is precisely measured to make sure that the surfaces which should not cause reflective glare, don't.

This same meticulous care is applied to instrumentation, visors, compartments, trims and hardware. This is craftsmanship of the sort you may have thought long gone. Not on an Oldsmobile. Every 1988 Oldsmobile, from the Touring Sedan to the Cutlass Calais International Series to the Cutlass Calais International Series to the Firenza, features the same care and expertise. The reason is simple. It is the Oldsmobile way. The Oldsmobile tradition. The Oldsmobile commitment.

It is Oldsmobile. And you know it from the moment you get inside and take a seat. It is the touch, look and feel of Oldsmobile quality.

*Headrest integrated with the design of the seat back. Object: Contour integrity and head and neck support.*

*Reinforced steel shell seat structure provides the most desirable positioning and structural support in a space-saving form.*

*Seat cushioning of high-resilience, long-lasting polyurethane foam. Provides an optimum combination of support, softness and shape retention over time. A well-defined substrate formed to the ergonomical needs of most drivers.*

*Lumbar and lateral support designed in for optimum body support and comfort. Full reclining feature for driver and front passenger seats is standard on Cutlass Calais and Firenza models.*

*Manual seating provides a studiously-arrived-at seat height which meets the comfort needs of 95% of all drivers. And front/rear seat movement which is two inches greater than 1987 models provides a full range of leg position choices.*

*Seat track and manual or power adjusting designed to provide the maximum range of comfort that advanced seating technology allows. Available 6-way power adjusters adjust seating height, tilt, and front/rear distance over an amazing range of positions.*

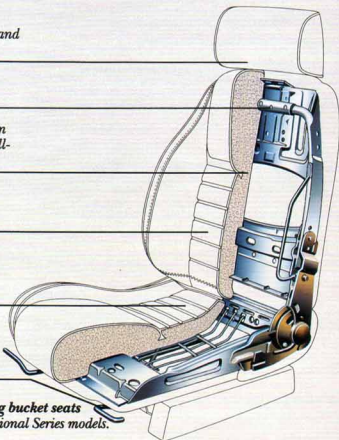

*The new Oldsmobile International Series version reclining bucket seats for Olds Cutlass Ciera and Cutlass Calais International Series models.*

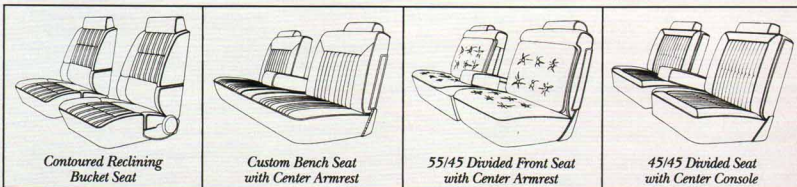

*Contoured Reclining Bucket Seat*

*Custom Bench Seat with Center Armrest*

*55/45 Divided Front Seat with Center Armrest*

*45/45 Divided Seat with Center Console*

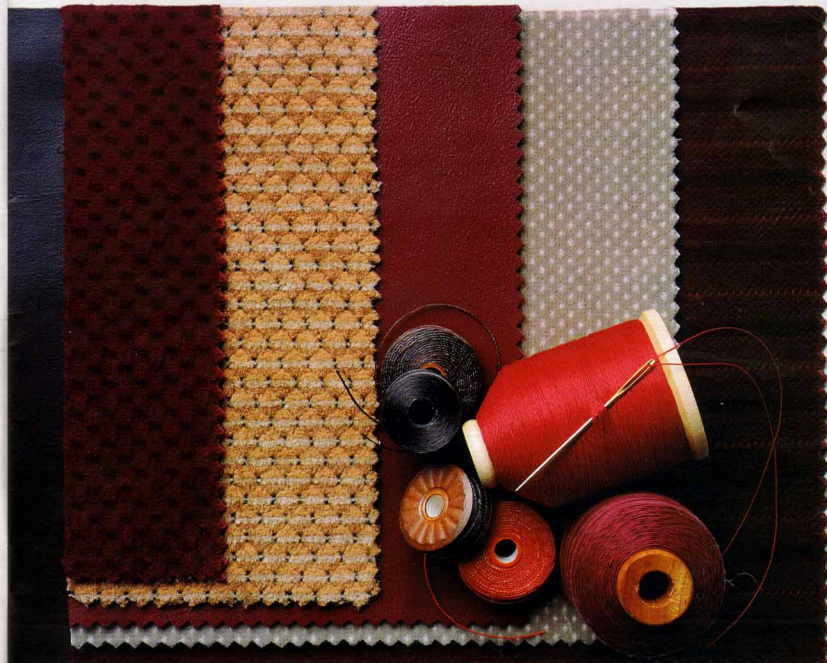



## CUTLASS CALAIS

*WE THINK A PERFORMANCE CAR CAN BE DESIGNED TO FIT NEATLY INTO YOUR LIFE. NOT MERELY INTO YOUR GARAGE.*

**C**

*Like any car company, we have a very real passion for automotive performance. For precision handling. And for the response of a strong, solid powertrain. But we also have a healthy respect for practical and dependable transportation. So that's the common sense we put behind the newest member of the Oldsmobile Cutlass family, the 1988 Cutlass Calais—an intelligent blend of sport styling, plus the room and comfort you need in your everyday life. Cutlass Calais isn't built on the philosophy that the American car buyer wants extravagance—it's built on the understanding that America's drivers want an automobile that delivers logical performance and practical styling. That's one of the reasons Cutlass Calais can be equipped with the kick of a Quad 4 engine—(after November 1). It's designed to deliver remarkably high horsepower in relation to engine displacement. The 1988 Cutlass Calais. More practical than some performance cars. But no less exciting.*

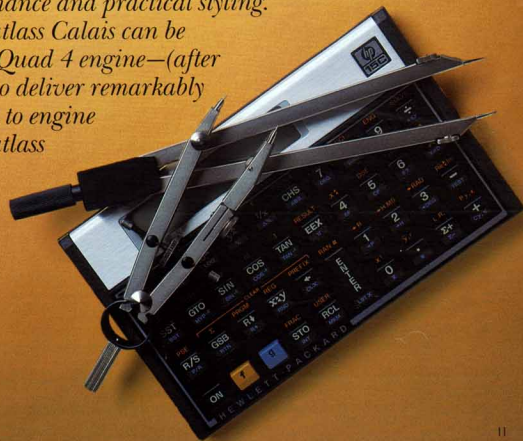



**ONE OF THE MOST RECENT ADVANCEMENTS IN AUTOMOTIVE ENGINEERING IS AN OLDSMOBILE. AND THIS IS IT.**

At the core of the 1988 Cutlass Calais International Series, there's a 2.3-liter,

dual overhead cam Quad 4 engine—16 valves, 4 cylinders and 150 horsepower at 5,200 rpm.\* Add to that, power rack-and-pinion steering, MacPherson front struts and FE3—the Olds Touring Car Ride and Handling suspension system. Front-wheel drive and a Getrag-licensed 5-speed manual transmission are also standard.

Inside, ergonomic contour reclining front bucket seats adjust 4 ways and neighbor a full-length console.

Outside, composite headlamps, aero rocker panels and special fascia moldings create a look that seems to translate "Oldsmobile" into German.

Of course, there is an inherent frustration to an automobile this full of international styling and driving

quality. Those who come to own a Cutlass Calais International Series may find themselves longing for less domestic roads than the daily commute.

*1. Cutlass Calais International Series cockpit with standard leather-wrapped sport steering wheel and analog gauges. 2. Cutlass Calais International Series Sedan.*

*\*Available after November 1, 1987.*



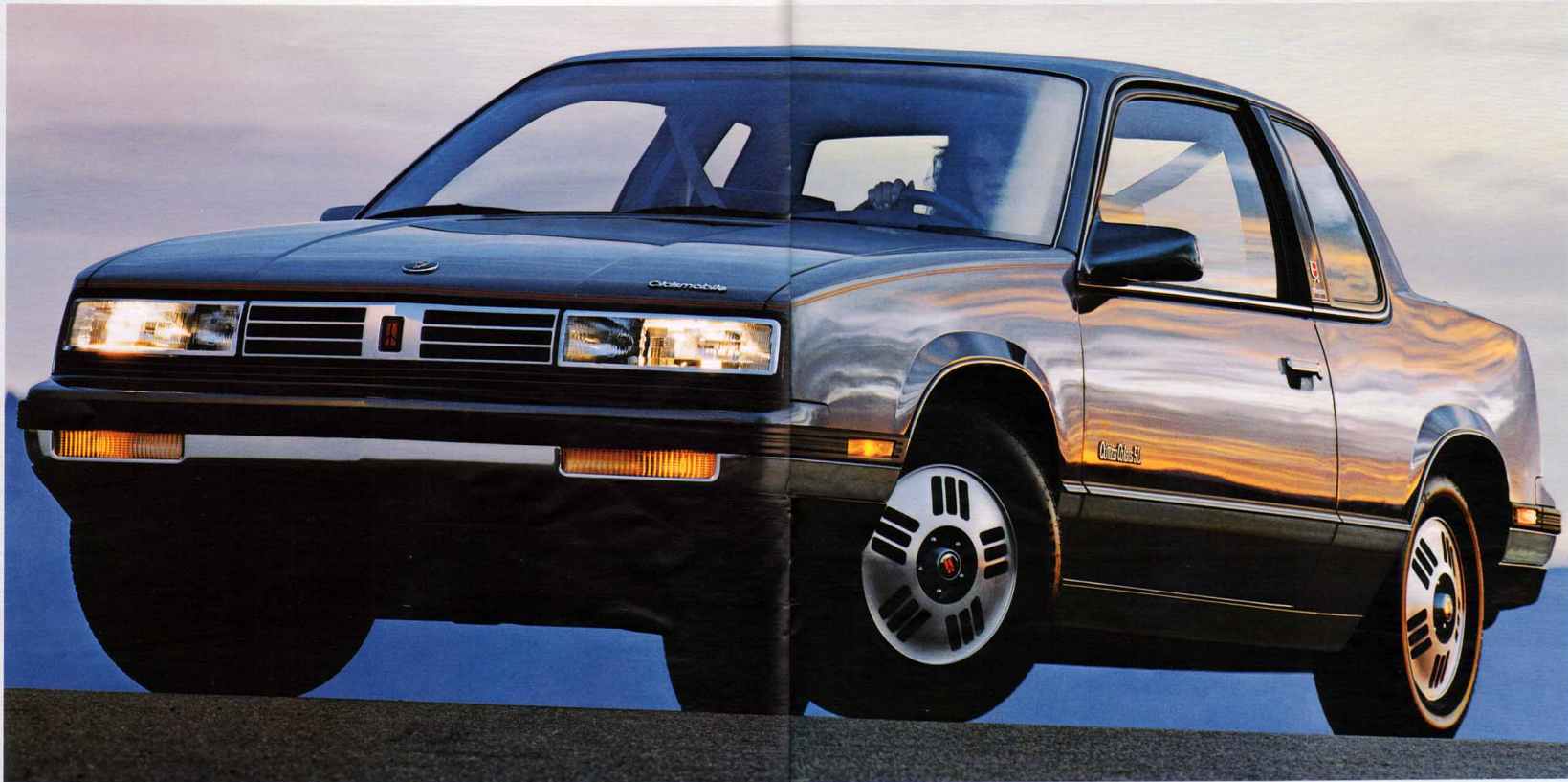

**KEEP IN MIND THERE IS ONE ELEMENT MORE VITAL TO AUTOMOTIVE PERFORMANCE THAN ANY OTHER. THE DRIVER.**

The performance of the 1988 Cutlass Calais SL comes from one very simple

theory—design every element of the car to satisfy every sense of the person who drives it.

The looks satisfy. Aerodynamic styling, black body side moldings and sporty rocker panels make for a smart silhouette.

The power satisfies, too. A standard 2.5-liter electronic fuel-injected Tech IV engine has newly added balance

shafts for smoother performance. And response can be boosted by an available 2.3-liter Quad 4\* or 3.0-liter V6—both with multiport fuel injection. Power rack-and-pinion steering, front-wheel drive and MacPherson front struts add still more road negotiating skill. And Oldsmobile's FE2 or FE3

special suspension system is available for firm handling and an enhanced ride.

Inside, comfort and control are satisfyingly apparent. Reclining front bucket seats position the driver in a cockpit full of information conveniences and advanced technology.

When the driver is satisfied with every feature, every function, even every nuance of an automobile, then

performance is at hand. Then, the automobile is a 1988 Cutlass Calais SL. Take a test drive.

*1. A sporty 5-speed transmission with full console stick shift is standard.*

*\*Available after November 1, 1987.*







**THERE IS A PLACE WHERE PERFORMANCE BLENDS PERFECTLY WITH COMFORT. IT'S INSIDE THIS CAR.**

It's here where designers and engineers have made sure that the spirited ride of a Cutlass Calais is enjoyed amidst practical luxury and comfort. They've included full-foam, fully reclining front bucket seats, plus abundant legroom and headroom in

the rear. And they've calculated every function, operation and space relationship to fit the driver and passengers precisely.

1. Cutlass Calais International Series interior with standard Medium Gray Strata weave cloth. (Morocco perforated leather in the seating areas in Medium Gray or Dark Garnet Red is also available.) 2. Cutlass Calais SL with optional Dark Garnet Red leather in the seating areas. (Also available in Medium Beechwood.) 3. Cutlass Calais SL with standard Paris knit velour is avail-

able in Dark Sapphire Blue, Medium Gray, Dark Garnet Red and Medium Beechwood. 4. Cutlass Calais with standard Summit knit velour. 5. Automatic safety belts are standard.



**DESPITE THE IMPRESSIVE LIST OF OPTIONS ASSOCIATED WITH CUTLASS CALAIS, IT NARROWS DOWN TO ONLY ONE CHOICE. SMART OR SMARTER STILL.**

Selecting a 1988 Cutlass Calais and deciding just how it will be equipped may not be easy. Quite simply, because there's so much to choose from.

There's Cutlass Calais, Cutlass Calais SL and Cutlass Calais International Series—each in stylish coupe and sedan models.

There's a wide range of power choices. From a 2.5-liter Tech IV engine with electronic fuel injection to a 3.0-liter V6 with multipoint fuel injection. And the all-new 2.3-liter Quad 4\* powerhouse that's standard on Cutlass Calais International Series is still an option on every other Cutlass Calais. A 5-speed manual transmission is standard, plus there's a high torque



capacity 5-speed manual or 3-speed automatic transmission available. Each Cutlass Calais also offers available option packages that add things like Tilt-Wheel steering, pulse wipers and Cruise Control with electronic resume and acceleration features. Power door locks, power windows and power trunk release are available. You can include a Rallye instrument cluster with tachometer, voltmeter, temperature and oil pressure gages. And with a Quad 4 engine\* you can opt for the advanced operations of a digital Driver Information System that provides an update on virtually every vital engine function. (And then some.)

Other optional tires, wheel covers, plus sound systems and exterior sport packages, are on the list, too. So are two of Oldsmobile's special suspension systems—the Level II Load-Carrying suspension system includes firm ride shock absorbers, a larger front stabilizer bar and additional rear stabilizer bar, plus special steering gear. And the Level III Ride and Handling suspension system consists of special suspension components, a leather-wrapped sport steering wheel, aluminum styled 14" wheels and steel-belted radial-ply,

blackwall performance tires.

Sure, you'll have to decide just how smart your 1988 Cutlass Calais will be. But with everything you have to choose from, we've made it impossible to make a mistake in the process.

1. The all-new available 16-valve, 4-cylinder, dual overhead cam Quad 4 engine.\* 2. A split-folding rear seat with trunk pass-through is standard on Cutlass Calais SL and International Series models. 3. Optional Driver Information System provides digital read-out



of fuel economy, range, service reminders, tachometer and more. 4. The 1988 Cutlass Calais Sedan. 5. Cutlass Calais Coupe.

\*Available after November 1, 1987.



CUTLASS CALAIS International Series Interior/Features

CUTLASS CALAIS International Series Interior/Features

CUTLASS SUPREMACY CLASSIC p. 35

FIRENZA p. 41

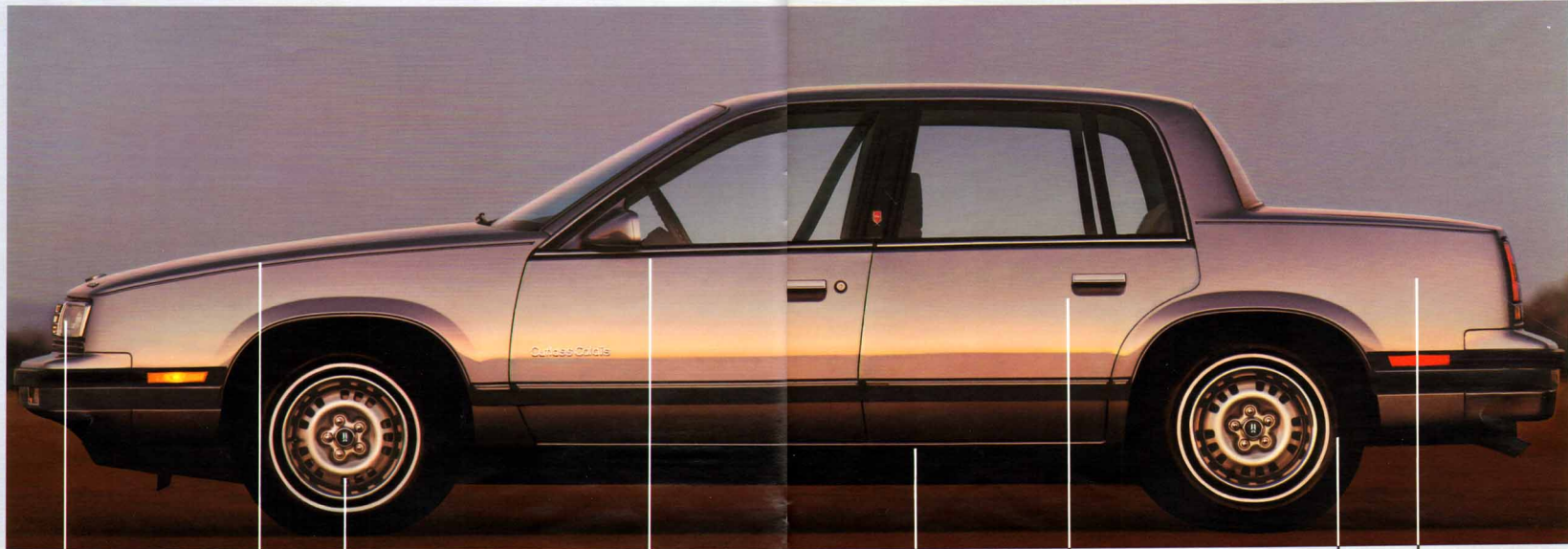

Composite Tungsten halogen headlamps (high beams)  
 2.5-liter electronic fuel-injected Tech IV engine  
 Low-drag power front disc brakes  
 5-speed manual transmission and power rack-and-pinion steering  
 Extensive anti-corrosion measures throughout  
 Comfortable 5-passenger seating capacity  
 Semi-independent rear suspension  
 Practical luggage capacity

**CUTLASS CALAIS. UNDERNEATH,  
IT'S EVEN SMARTER THAN IT LOOKS.**

**CUTLASS CALAIS POWERTRAIN SPECIFICATIONS**

ENGINE	STANDARD	AVAILABLE	AVAILABLE
Displacement	2.5-liter (151 cu. in.)	2.3-liter (140 cu. in.)*	3.0-liter (183 cu. in.)
Engine	4-cylinder	DOHC, 4-cylinder	V6
Break HP (rpm)	98 @ 4800	150 @ 5200	125 @ 4900
Net torque (lbs. ft.)	135 @ 3200	160 @ 4000	150 @ 2400
Bore/Stroke (in.)	4.000/3.000	3.62/3.35	3.800/2.660
Compression ratio	8.5 to 1	8.5 to 1	8.5 to 1
Fuel management, fuel-injected	Electronic	Multiport	Multiport
Cooling system (qt.)	7.8	7.8	7.8

**DRIVELINE**

Transmission	5-speed manual (std.)	5-speed manual (std.)	3-speed automatic (std.)
Final drive ratio	3.35 to 1	3.61 to 1	2.53 to 1 (auto)

**SUSPENSION/HANDLING**

Front	Mac-Pherson struts	Mac-Pherson struts	Mac-Pherson struts
Rear	Semi-independent	Semi-independent	Semi-independent
Trailer towing capacity (lbs.)*	1000	1000	1000

\*Quad 4, standard on International Series models. †Recommended maximum capacity when properly equipped. Includes passengers, cargo and equipment.

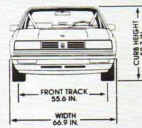
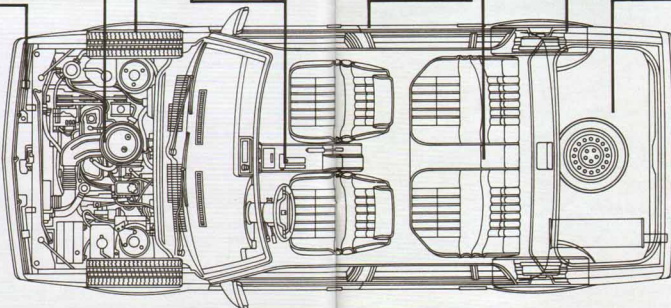

**CUTLASS CALAIS DIMENSIONS**

BODY/CHASSIS	COUPE	SEDAN
Wheelbase (in.)	103.4	103.4
Track, front/rear (in.)	55.6/55.2	55.6/55.2
Tire size (std.)	P185/BOR13	P185/BOR13
Wheel size	13 x 5.5	13 x 5.5
Brake type, front/rear	Disc/Drum	Disc/Drum
Fuel tank (gals.)	13.6	13.6

**EXTERIOR**

Length (in.)	178.8	178.8
Width (in.)	66.7	66.9
Height (in.) (curb)	52.4	52.3
Curb weight (lbs.)	2470/2498 SL	2539/2560 SL

**INTERIOR**

Headroom, front/rear (in.)	37.7/37.1	37.7/37.1
Legroom, front/rear (in.)	42.9/34.3	42.9/34.3
Shoulder room, front/rear (in.)	53.9/55.1	53.9/53.5
Seating capacity	5	5
Trunk capacity (cu. ft.)	13.2	13.2



*Cutlass Ciera SL Coupe*

*Oldsmobile Design*

## CUTLASS CIERA

**EVERYTHING IS BUILT TO LAST. INCLUDING THE SATISFACTION.**

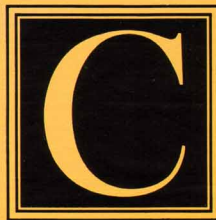

When Olds Cutlass Ciera made its debut, it quickly became America's "security blanket." Rugged, dependable and built to last—Cutlass Ciera is always there when you need it. Popular with men, it's also a favorite with women and young marrieds. What makes Cutlass Ciera such an all-around favorite is its knack for doing so many things so well. Its enduring styling, for example, is fresh and contemporary. It doesn't come in one year and go out the next. Inside, there's room for today's active families—with full-foam seats and comfort for all. Lots of value, too—with extensive anti-corrosion treatments and long-life aluminized exhaust system. Performance is fuel-injected and very capable. The ride is as you'd expect—Oldsmobile smooth. It's easy to handle. And a snap to park. Cutlass Ciera, America's most popular Oldsmobile. It's a car—and a decision—you can be comfortable with for a long, long time.

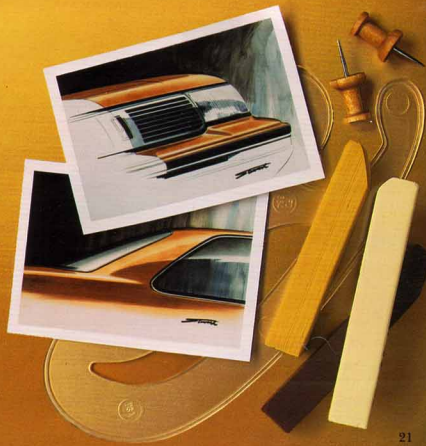



**CUTLASS CIERA  
INTERNATIONAL SERIES**

**IT'S YOUR PASSPORT TO A  
NEW DRIVING EXPERIENCE.**

From front air dam and fog-lamps to rear aero extensions—Cutlass Ciera International Series has a look of its own. An international look with black grille and black trim. But head down some challenging real estate, and the International Series speaks your language!

Performance is impressive with the 3.8-liter sequential port fuel-

injected V6 and strong 4-speed automatic overdrive transmission. Handling is world-class—with Oldsmobile's most sophisticated Level III (FE3) suspension system.

Take the wheel and head for the open road. You'll find that the new Olds Cutlass Ciera International Series is out of this world!

*1. Full instrumentation, leather-wrapped sport steering wheel, sport console, and reclining front bucket seats are all standard. Available perforated leather in the seating areas. Choose from Dark Claret or Medium Gray. 2. This distinctive Cutlass Ciera International Series Sedan is also available.*





CUTLASS CIERA  
Brougham Sedan

**CUTLASS CIERA  
BROUGHAM SEDAN**

**WITH ITS "H-POINT"  
DESIGNING, THIS MIDSIZE  
SEDAN CAN COMFORTABLY  
ACCOMMODATE 95% OF  
AMERICA'S DRIVERS.**

Whether you're four-foot-eleven or six-foot-two, when you slide into Cutlass Ciera Brougham Sedan, you feel like the interior was designed exactly for you.

And it was! That's what our "H-point" ergonomics is all about. The "H-point" is where hip and leg meet. All critical

interior dimensions emanate from there: leg to foot pedal... thigh to seat cushion... back to seat back... arms to steering wheel... head to ceiling... and eyes to instrument panel.

Move the seat forward, and it rises, providing a chair-high seat for smaller people, while comfortably maintaining

all "H-point" positions.

Slide the seat back, and six-footers are equally accommodated.

Cutlass Ciera Brougham is also accommodating when it comes to features. Front-wheel drive, an ETR AM/FM stereo radio, power rack-and-pinion steering, 2.5-liter Tech IV engine with electronic fuel injection and 3-speed automatic

transmission are all standard.

It all adds up to Cutlass Ciera value. And what could be more accommodating than that?

You'd enjoy a test drive. Take one.

*1. Interior design engineers calibrate "H-point" positions.*





**DESIGNING AN INTERIOR TO LOOK THIS GOOD IS ONE THING. SEEING THAT IT STAYS THAT WAY IS ANOTHER STORY.**

"Double malt. Fries with extra ketchup. Giant taco, and don't hold the sauce! Oooooops!"

That's just a smattering of the kind of abuse an interior might be subjected to. Sure, an interior has to be beautiful. But it also has to be tough—year-after-year and spill-after-spill tough. It has to be as stain-resistant as possible, clean up quickly and easily, and be ready to come back for more.

After all, a Cutlass Ciera interior isn't intended to be some finicky or persnickety living room. It's a family

room, meant to be used and fully enjoyed, and take it all in stride.

So...come on, family, climb on board. Relax. And enjoy!

The Cutlass Ciera Brougham Sedan's interior is shown in Dark Claret Paris knit velour with 55/45 divided front seat, dual controls and fold-down center armrest. The driver's seat back reclines. Also available in Dark Sapphire Blue, Medium Beechwood and Medium Gray.

1. Cutlass Ciera Brougham's 55/45 seat with available leather in the seating areas. Smooth, supple and long wearing. 2. Newly available, a center armrest with extra storage convenience. Just the place for parking change, cassette tapes, or car phone. Provides a built-in holder for coffee or soft drink, too. Close it and it's a comfortable armrest.



*The Cutlass Ciera SL and Brougham interior provides an elegant look that is in fashion for every occasion. It features this subtly striped Paris knit velour. Smooth and soft, with the feel of cashmere.*

*The subtle stripes are complemented with this bold, solid-colored Paris knit velour used as seat trim and door panel highlights.*

*The seat trim is completed with Doeskin vinyl for added strength and exceptional durability.*





**WE DON'T JUST ADD FEATURES. WE ADD YEARS, SATISFYING YEARS!**

We like to think of Cutlass Ciera as a time machine. It's built to be tough, styled to be enduring, engineered to be dependable and proven to be a solid value—year after year.

From zincrometals and galvanized body parts to hot-melt wax dips and

lower body anti-chip plastisol, Cutlass Ciera is built to last. We even aluminum-coat the welds on the Ciera's aluminum-coated muffler.

The fact is, you can be enjoying your Cutlass Ciera long after the payment book is gathering dust.

However, if the day ever comes when you do decide to part company, it should be a very pleasant day indeed. Because Cutlass Ciera traditionally returns a high resale value.

**CUTLASS CIERA IS DRAMATIC PROOF THAT DISTINCTIVE AUTOMOTIVE DESIGN IS NOT A LOST ART.**

You might not expect an automobile that looks so stylish to be so practical. But that's Olds Cutlass Ciera. Its graceful styling helps make it America's favorite Oldsmobile.

But when the engineers and stylists had finished, Cutlass Ciera's looks were more than flattering. They were functional, as well.

The overall shape, for example, is wedge-like in design. That allows it to easily and silently slice through the air. Air's resistance is further reduced with the addition of smooth composite headlamps.

The windshield moldings are virtually flat and meld into the roofline so as not to disrupt the air's flow. Ditto for door handles that snugly and smugly hug the body. Even the exterior mirrors and wheel discs are carefully designed to reduce the effects of air resistance.

The sleek and stylish results: an impressively low-drag coefficient of just .35\*—for a six-passenger car! And that pays off in some very practical translations. For example, road-handling characteristics are enhanced. And the ride is smooth, quiet, and very relaxing.

Cutlass Ciera is as space-efficient inside as it is wind-efficient outside.

There's lots of room for a family of six, making it one great midsize family car. And what's a family car without a spacious trunk? So the engineers ably provide one, offering 15.8 cubic feet of that precious commodity in both coupe and sedan models.

And about that horsepower? There's a whole stable-full. The newly refined 2.5-liter electronically fuel-injected Tech IV engine is standard. Its new balance shafts and new low-friction pistons mean even smoother, quieter operation than before.

For added performance, a 2.8-liter multiport fuel-injected V6 is available. Or if it's true premium performance you're looking for, a 3.8-liter sequential port fuel-injected V6 can be ordered.

It's so powerful that its recommended trailer towing capacity has

been increased to 3,000 pounds! So now you can use your "dream boat" to tow your dream boat!

1. Cutlass Ciera 2.8-liter V6 with multiport fuel injection. It is easily accessible and designed for serviceability. 2. Cutlass Ciera can gobble up all that luggage and go looking for more. There are 15.8 cubic feet of cargo space in coupe and sedan. 3. It's a sunroof. It's a refreshing vent. It's a shaded roof. It's available and it's your choice. Just pick the mode that suits your mood. Sedan models only. 4. Out of sight. A convenient storage compartment on the rear window ledge. Perfect for small personal items. Standard on coupe models (except Ciera Coupe). 5. Head for the open road. With its sleek aerodynamics, the drive is impressively smooth, quiet, and very relaxing!

\*Based on G.M. tests. †When properly equipped. Includes passengers, cargo and equipment.

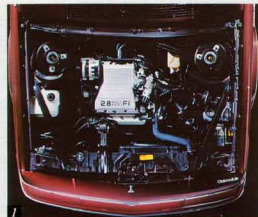



## CUTLASS CRUISER

### YOU GET A LOT MORE OUT OF IT THAN YOU PUT INTO IT.

You can put a lot into a Cutlass Cruiser. Including you and your family. That's why Cutlass Cruiser is no ordinary station wagon.

It's an Oldsmobile! And that means Oldsmobile room—with excellent accommodations for six passengers. And you can easily make it eight—with the available rear-facing third seat. It means a big Oldsmobile ride that is both smooth and quiet, with front-wheel drive and MacPherson strut front suspension.

And of course, there are all those Oldsmobile conveniences. A hidden storage area for valuables. And a two-way tailgate that lets you load smaller items through the tailgate window—or load larger items with the tailgate fully open and conveniently up and out of your way.

Look around, and you immediately see that Oldsmobile quality and luxury touches surround you—from the rich Bronite velour upholstery to the long and fully carpeted cargo floor.

Oldsmobile Cutlass Cruiser and Cutlass Cruiser Brougham. You get more out of them, because we put more into them.

As for performance, well, that's an Oldsmobile long suit. A quick and dependable 2.8-liter multiport fuel-injected V6 power plant is available. And you can also order premium performance if you like. It's available in the spirited 3.8-liter sequential port fuel-injected V6.

Incidentally, Cutlass Cruiser is right at home on long hauls and trailer towing. With recommended equipment, it can tow up to 3,500 pounds.\* So...pack up all your cares and go!

\*Includes passengers, cargo and equipment.

CUTLASS CRUISER  
Brougham/Features



### CUTLASS CRUISER OR CUTLASS CRUISER BROUGHAM. A DECISION YOU CAN LIVE WITH—VERY COMFORTABLY.

Brougham models feature a 55/45

divided bench front seat with center armrest and dual controls. The Paris knit velour is available in Dark Sapphire Blue, Medium Gray and Dark Claret. Sierra grain leather is available in the seating areas.

Cutlass Cruiser has a custom bench front seat with center armrest in Bronite velour. Select from Dark Sapphire Blue, Medium Gray, Dark Claret and Medium Beechwood. The



55/45 divided seat is available.

Choose your power! A 2.5-liter Tech IV engine with electronic fuel injection is standard. A 2.8-liter multiport fuel-injected V6 and premium performance 3.8-liter sequential port fuel-injected V6 are available.

#### CUTLASS CRUISER CARGO AREA DIMENSIONS

Maximum cargo volume (cu. ft.)	74.4
Floor length from back of front seat to end of floor surface (in.)	75.4
Floor length from back of second seat to end of floor surface (in.)	45.4
Minimum horizontal distance from top of rear of front seat back to inside of tailgate at belt (in.)	72.4
Minimum distance between wheelhouses at floor level (in.)	36.6
Rear-end opening width at belt (in.)	49.4
Maximum height of rear opening, tailgate open (in.)	28.7
Maximum cargo height (in.)	31.6

*1. Cutlass Cruiser with available roof luggage rack and rear wind deflector. 2. Load floor is long and flat—and fully carpeted. 74.4 cubic feet of cargo space. 3. You can load small packages by simply opening the tailgate window!*





Aerodynamic composite headlamps with halogen high beams

2.5-liter Tech IV engine with electronic fuel injection

Power front disc brakes

Front-wheel drive and MacPherson strut front suspension

3-speed automatic transmission and power rack-and-pinion steering

Extensive anti-corrosion measures throughout

Family-sized head- and legroom, front and rear

Large, space-efficient luggage compartment

**BENEATH THAT GLEAMING FINISH,  
CUTLASS CIERA VALUE IS BUILT TO LAST.**

**CUTLASS CIERA POWERTRAIN SPECIFICATIONS**

ENGINE	STANDARD	AVAILABLE	AVAILABLE*
Displacement	2.5-liter (151 cu. in.)	2.8-liter (173 cu. in.)	3.8-liter (231 cu. in.)
Engine	4-cylinder	V6	V6
Brake HP (rpm)	98 @ 4800	125 @ 4500	150 @ 4400
Net torque (lbs. ft.)	135 @ 3200	160 @ 3600	200 @ 2000
Bore/Stroke (in.)	4.000/3.000	3.504/2.988	3.800/3.400
Compression ratio	8.5 to 1	8.5 to 1	8.5 to 1
Fuel management, fuel-injected	Electronic	Multiport	Sequential Port
Cooling system, auto/manual (qt.)	98/99	12.5	12.52, high-capacity
<b>DRIVELINE</b>			
Transaxle	3-speed automatic	3-speed automatic	4-speed automatic
Final drive ratio	2.84 to 1	2.84 to 1	2.84 to 1

**SUSPENSION/HANDLING**

	MacPherson struts	MacPherson struts	MacPherson struts
Front	MacPherson struts	MacPherson struts	MacPherson struts
Rear	Semi-independent	Semi-independent	Semi-independent
Trailer towing capacity (lbs.)**	1000	1000	3000

\*Standard on International Series models. \*\*Recommended maximum capacity when properly equipped. Includes passengers, cargo and equipment.

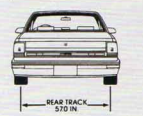
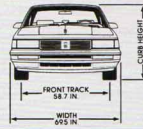
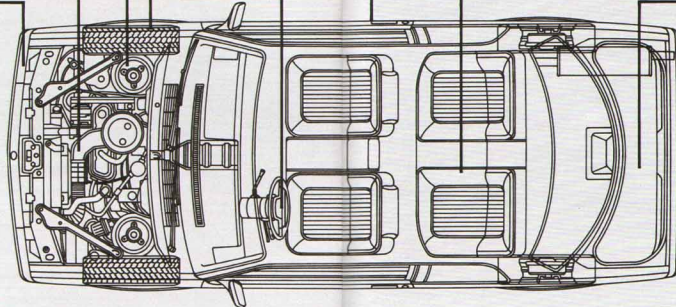

**CUTLASS CIERA DIMENSIONS**

BODY/CHASSIS	COUPE	SEDAN
Wheelbase (in.)	104.9	104.9
Track, front/rear (in.)	58.7/57.0	58.7/57.0
Tire size (std.)	P185/75R14	P185/75R14
Wheel size	14 x 5.5	14 x 5.5
Brake type, front/rear	Disc/Drum	Disc/Drum
Fuel tank (gals.)	15.7	15.7

**EXTERIOR**

Length (in.)	190.3	190.3
Width (in.)	69.5	69.5
Height (in.) (courts)	54.1	54.1
Curb weight (lbs.)	2769 2780 SL	2733 2804 Bc

**INTERIOR**

Headroom, front/rear (in.)	38.6/37.6	38.6/38.0
Legroom, front/rear (in.)	42.1/35.8	42.1/35.8
Shoulder room, fr./r. (in.)	56.6/56.9	56.2/56.2
Seating capacity	6	6
Trunk capacity (cu. ft.)	15.8	15.8



## CUTLASS SUPREME CLASSIC

THINK OF YOUR FONDEST MEMORIES, YOUR BIGGEST ACCOMPLISHMENTS AND YOUR CLOSEST FRIENDS. ADD THIS TO THE LIST.

**C** Within the ever-changing, ever-rearranging automotive marketplace, there are only a few real "classics" that remain. But remain they do, because of their lasting value and trusted performance. This Oldsmobile is one. In fact, it's been a respected classic for quite a few years. You see, like no other car in the world, the Cutlass Supreme Classic transcends the trends. It commands the attention of America's most discriminating car buyers. And it continues to deliver time-tested, time-honored quality. Of course, it also delivers truly distinctive styling—both inside and outside. Plus, there are any number of interior and exterior features (both standard and optional) that add that much more to its already exemplary comfort and handling. Gratefully, the 1988 Cutlass Supreme Classic doesn't digress from its heritage—enduring value and compelling V8 performance continue to make it an Oldsmobile classic. A wisdom-filled value. And a sentimental favorite.

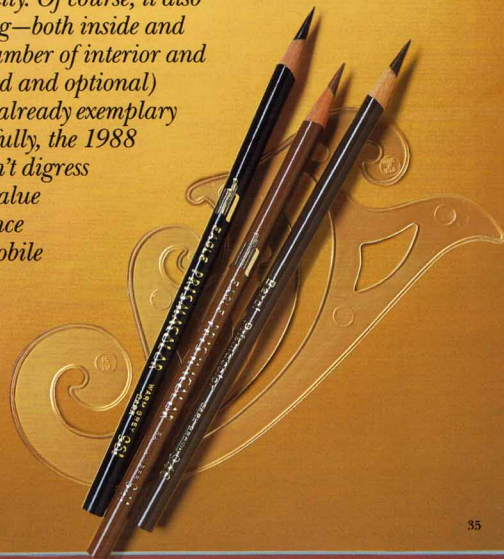



**DESIGNERS HAVE PLANNED THIS TO MEET THE EXPECTATIONS OF SIX VERY IMPORTANT PEOPLE. YOU AND YOUR PASSENGERS.**

Inside the Cutlass Supreme Classic comes the real enjoyment of sitting atop a 108-inch wheelbase. There's more than enough space to stretch out and plenty of sporty elegance to sur-



round you. There's a custom front bench seat, plus fold-down armrests, front and rear. And there's the option of a 55/45 bench or contour reclining front buckets with a floor console and shifter. Six-passenger room. Six-passenger comfort. Six-passenger expectations met.

1. Cutlass Supreme Classic Brougham comes with a standard dual-control 55/45 divided front bench seat covered in luxurious Summit knit velour. Available fabric colors



include Dark Teal Blue, Medium Gray, Dark Claret and Light Saddle. 2. Cutlass Supreme Classic offers the option of reclining front bucket seats and Bronte velour fabric in four colors. 3. Available Rallye instrument panel includes tachometer, trip odometer, voltmeter, temperature and oil pressure gauges. 4. Convenient console storage compartment is standard with bucket seats and console shifter.

## THIS CAR IS EQUIPPED WITH DECIDEDLY MORE HERITAGE THAN MOST.

1988 may be the first year some people experience the proud ownership of a Cutlass Supreme Classic. However, for some, it could easily be yet another return to Cutlass Supreme style.

For years, this Oldsmobile has maintained an unequalled stronghold in its class. And with good reason. Beyond the obvious performance and comfort features, beyond the impressive road stance and confident V8 power, there's the clear wisdom of the Cutlass Supreme Classic—its impressive quality and traditionally high resale value.

Still, while Cutlass Supreme Classic is equipped with decades of heritage, it's also equipped with a bevy of other pleasures—both standard and optional.

For starters, there's a 5.0-liter V8 engine and 4-speed automatic over-drive transmission. Independent front suspension with coil springs and stabilizer bar is standard. Power steering and power front disc and rear drum brakes are also a given. And the FE2 Firm Ride and Handling suspension system is available.

Inside, there are three front seat configurations to choose from. A Delco ETR AM/FM stereo radio with seek-scan is standard. And options such as Tilt-Wheel steering, Cruise Control, power windows, power door locks and rear window defogger are all available.

Outside, the distinctive style of Cutlass Supreme can be enhanced by

your choice of an available landau roof or removable glass roof panels. And on Cutlass Supreme Classic Brougham, an available silver-tint electrically operated glass moonroof is yours for the ordering. You can also add special body side moldings and wheel covers to further enhance the already impressive appearance of your Cutlass Supreme Classic.

So no matter how you equip a 1988 Cutlass Supreme Classic, it's backed by Oldsmobile quality and GM's 6-year/60,000-mile powertrain warranty.\* As well as by virtue of its classic heritage.

1. The Cutlass Supreme Classic 5.0-liter, 4-barrel V8 power plant. 2. The 1988 Cutlass Supreme Classic. The contemporary car that lives up to its name. 3. The 1988 Cutlass Supreme Classic Brougham.

\*See your dealer for the terms and conditions of this limited warranty.

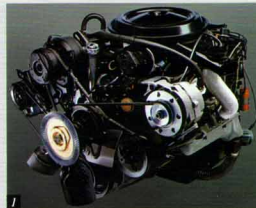

CUTLASS SUPREME CLASSIC Brougham Interior/Features



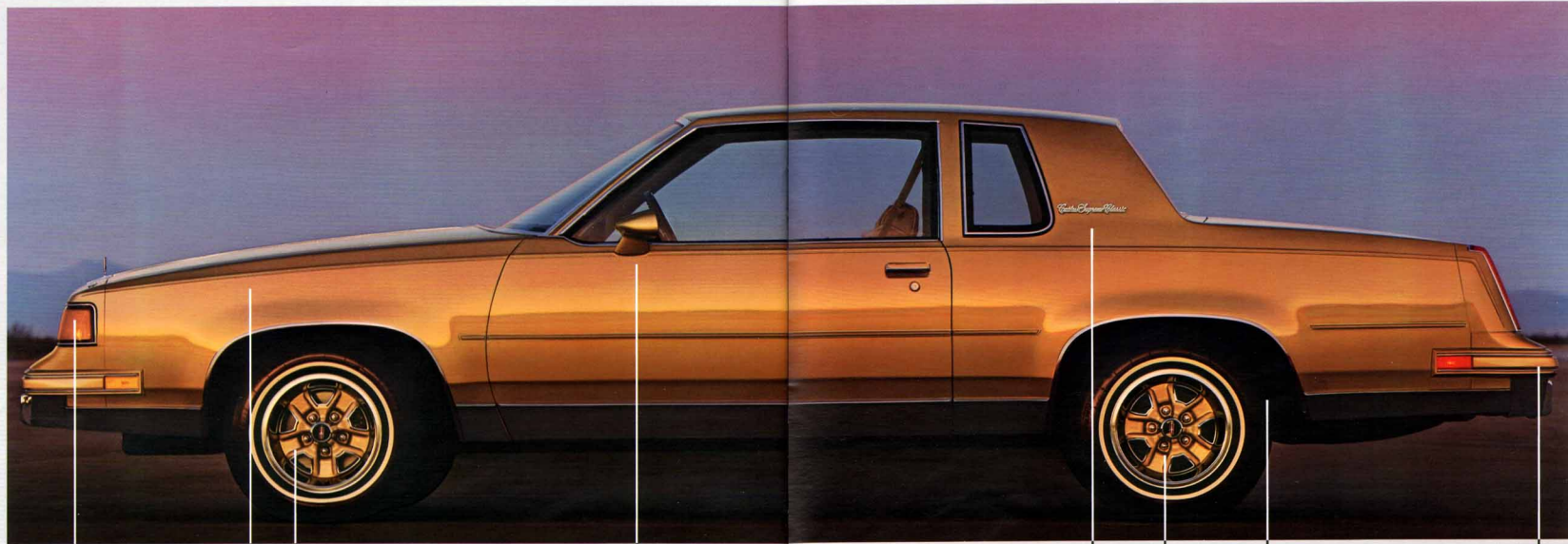

Dual composite headlamps

5.0-liter 4-barrel V8 engine

Independent front suspension with coil springs and stabilizer bar. Power front disc brakes

4-speed automatic overdrive transmission

Dual rear sound system speakers  
Available super stock wheels

Deep-coil springs

Bumper impact strips, front and rear

THESE ARE THE THINGS  
THAT LEGENDS ARE MADE OF

CUTLASS SUPREME CLASSIC POWERTRAIN SPECIFICATIONS

ENGINE	STANDARD
Displacement	5.0-liter (307 cu. in.)
Engine	V8
Brake HP (rpm)	140 @ 3200
Net torque (lbs. ft.)	255 @ 2000
Bore/Stroke (in.)	3.800/3.385
Compression ratio	799 to 1
Fuel management	4-barrel
Cooling system (qt.)	14.9

DRIVELINE

Transmission	4-speed automatic
Axle	2.56 to 1

SUSPENSION/HANDLING

Front	Deep coil springs
Rear	Deep coil springs
Front turning diameter, curb to curb (ft.)	38.2
Trailer towing capacity (lbs.)*	4000

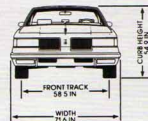
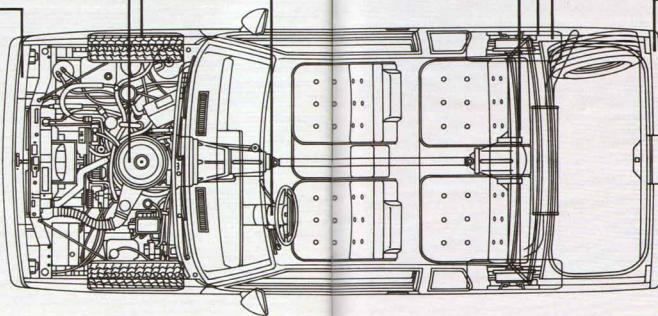

CUTLASS SUPREME CLASSIC DIMENSIONS

BODY/CHASSIS	COUPE	BR. COUPE
Wheelbase (in.)	108.1	108.1
Track, front/rear (in.)	58.5/57.7	58.5/57.7
Tire size	P195/75R14	P195/75R14
Wheel size	14 x 6	14 x 6
Brake type, front/rear	Disc/Drum	Disc/Drum
Fuel tank (gals.)	18.1	18.1

EXTERIOR

Length (in.)	200.0	200.4
Width (in.)	71.6	71.9
Height (in.) (curb)	54.9	54.9
Curb weight (lbs.)	3203	3233

INTERIOR

Headroom, front/rear (in.)	38.1/38.3*	38.1/37.8*
Legroom, front/rear (in.)	42.8/36.3	42.8/36.7
Shoulder room, front/rear (in.)	56.7/56.1	56.7/56.1
Seating capacity	6	6
Trunk capacity (cu. ft.)	16.2	16.2

\*Headroom is reduced when Astroroof is ordered.



## FIRENZA

*WE PUT JUST AS MUCH QUALITY  
INTO THIS OLDSMOBILE AS ANY OTHER.  
BUT NOT AS MUCH PRICE.*

**F**

*Over the past 90 years, Oldsmobile has come to be known for automobiles of a caliber that far surpasses the ordinary. Automobiles that represent superior and outstanding quality. It's an image we're extremely proud of. An image we've worked very hard to establish. And one we're committed to not only maintaining, but building on, as well. Still, along with that reputation for extraordinary quality, there comes the misunderstanding that a truly affordable, entry-level Oldsmobile does not exist. Not true. In fact, that's what the Olds Firenza is all about. It's every bit an Oldsmobile—full of quality styling and craftsmanship. Full of precision engineering and advanced technology. And although it may be smaller than other Oldsmobiles, the Firenza certainly doesn't skimp on room or comfort or style. The fact is, Firenza doesn't skimp on anything that Oldsmobile owners expect. We've simply included the extremely affordable sticker price of Firenza. And that's exactly what some Oldsmobile owners want.*

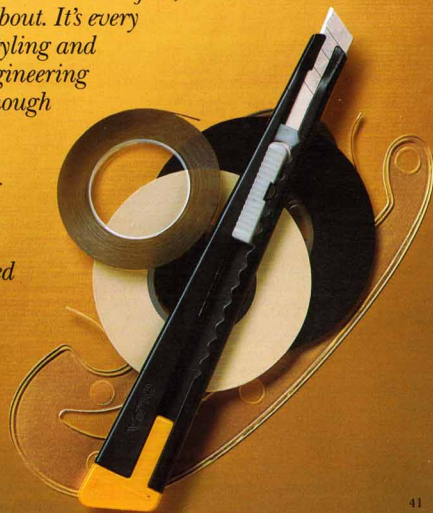



**EVERYTHING ABOUT THIS CAR WILL ASTOUND YOU. NOT YOUR CHECKBOOK.**

With Firenza, Oldsmobile has fully embraced the belief that you can be both car conscious and cost conscious at the same time. The front-wheel drive Firenza is packed with the power of a standard 2.0-liter transverse-mounted L4 engine with electronic fuel injection—an overhead cam L4 engine is also available. A 5-speed manual transmission, rack-and-pinion

steering and MacPherson front struts are also part of the package. And a litany of performance and comfort features are available. For example, six different option packages make it easy and convenient to personalize your new Firenza. There are two basic option packages. There's a power equipment package, a convenience package and a sport appearance package. And, number six, a sport equipment package that includes the Level III Ride and Handling suspension system, an instrument panel Rallye cluster and

more. Check out the complete list on page 47. The only thing you won't find is the option to pay more than you really want to.

*1. 1988 Firenza Coupe. 2. 1988 Firenza Sedan. 3. The sporty Firenza interior in Medium Gray Cascade weave fabric. Also available in Dark Sapphire Blue and Medium Beechwood.*



**WE'VE PUT A LOT INTO FIRENZA CRUISER SO THAT YOU CAN DO THE SAME.**

The 1988 Firenza Cruiser varies little from its Oldsmobile counterparts. That is, first it's an Olds, then it's a wagon. Which means that Firenza Cruiser is equipped with all the comfort and style you expect from an Oldsmobile. Plus, all the room and practicality you demand in a wagon. It's all there, alright. Everything but the big bottomline.

*1. 1988 Firenza Cruiser in Medium Gray Metallic. 2. Hidden under the cargo floor, there's still more storage. 3. Firenza delivers*

*63.4 cubic feet of carpeted cargo area with the rear seat down. 4. An available luggage rack adds extra carrying capacity.*

**FIRENZA CRUISER CARGO AREA DIMENSIONS**

Maximum cargo volume (cu. ft.)	63.4
Floor length from back of front seat to end of floor surface	67.3
Floor length from back of second seat to end of floor surface	38.6
Minimum horizontal distance from top of rear of front seat back to inside of tailgate at belt	62.2
Minimum distance between wheelhouses at floor level	37.2
Rear-end opening width at belt	47.5
Maximum height of rear opening, tailgate open	30.1
Maximum cargo height	33.3



2.0-liter transverse-mounted L4 engine  
 New side marker park-and-turn lamps  
 Newly designed grille and front-end panel with dual composite headlamps  
 Rack-and-pinion steering and power front disc brakes  
 5-speed manual console shifter  
 Swing-out rear quarter windows  
 High-capacity trunk space  
 New high-impact bumpers and fascia molding, front and rear

**HARD TO BELIEVE YOU CAN PACK THIS MUCH QUALITY INTO A COMPACT CAR.**

**FIRENZA POWERTRAIN SPECIFICATIONS**

ENGINE	STANDARD	AVAILABLE
Displacement	2.0-liter (122 cu. in.)	2.0-liter (122 cu. in.)
Engine	4-cylinder	4-cylinder
Broke HP (rpm)	90 @ 5600	96 @ 4800
Net torque (lbs. ft.)	108 @ 3200	118 @ 3600
Bore/Stroke (in.)	3.50/4.3150	3.380/3.380
Compression ratio	9.0 to 1	8.8 to 1
Fuel management	Fuel-injected	Electronic
Cooling system (qt.)	7.8	7.8
<b>DRIVELINE</b>		
Transaxle	5-speed manual (std.)	5-speed manual (std.)
Final drive ratio	3.45 to 1	3.45 to 1

**SUSPENSION/HANDLING**

Front	MacPherson struts	MacPherson struts
Rear	Semi-independent	Semi-independent
Front turning diameter (ft.)*	34.4/34.4	34.4/34.4
Trailer towing capacity (lbs.†)	1000	1000

\*Curb to curb, left-right. †Recommended maximum capacity when properly equipped. Includes passengers, cargo and equipment.

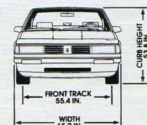
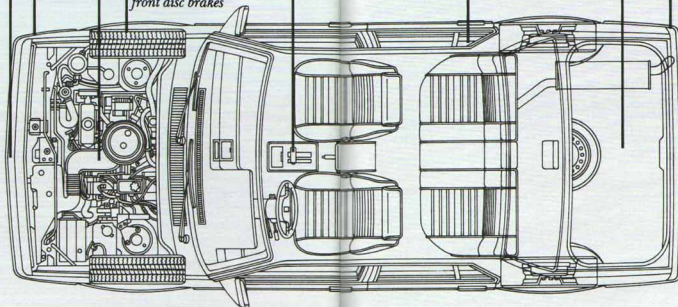

**FIRENZA DIMENSIONS**

BODY/CHASSIS	COUPE	SEDAN
Wheelbase (in.)	101.2	101.2
Track, front/rear (in.)	55.4/55.2	55.4/55.2
Tire size	P185/80R13	P185/80R13
Wheel size	13 x 5.5	13 x 5.5
Brake type, front/rear	Disc/Drum	Disc/Drum
Fuel tank (gals.)	13.6	13.6

**EXTERIOR**

Length (in.)	169.9	171.9
Width (in.)	65.0	65.0
Height (in.) (curb)	52.3	53.8
Curb weight (lbs.)	2327	2381

**INTERIOR**

Headroom, front/rear (in.)	37.7/36.7	38.6/38.0
Luggage, front/rear (cu. ft.)	42.1/31.8	42.2/34.3
Shoulder room, front/rear (in.)	53.5/53.5	53.4/53.3
Seating capacity	5	5
Trunk capacity (cu. ft.)	12.6	13.7

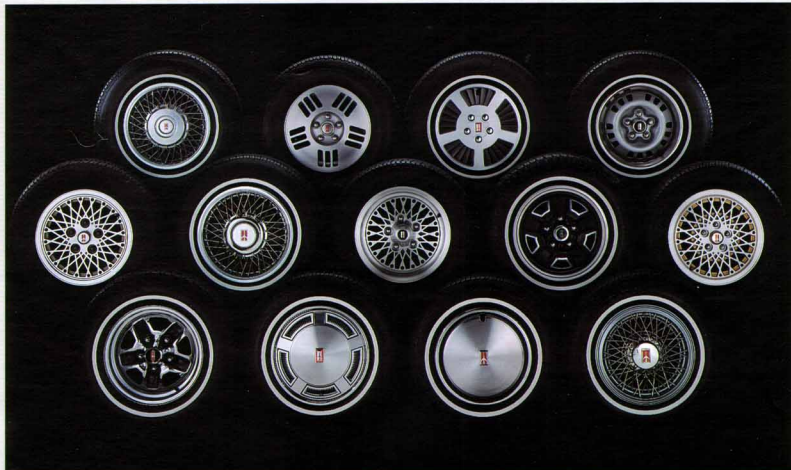

## STANDARD AND AVAILABLE WHEEL TRIMS

**TOP ROW, LEFT TO RIGHT...** Simulated Wire Wheel Disc with Lock (N91) available on all Firenza and all Cutlass Calais models except Calais International Series. Aluminum-Styled Wheel (PX1) available on all Firenza and Cutlass Calais models except Calais International Series. Deluxe Wheel Disc standard on all Firenza and Cutlass Calais models. Not available on Calais International Series. Super Stock Wheel (N78) available on all Cutlass Supreme Classic models. Super Stock Wheel (N67) Color-Coordinated with Stainless Steel Trim Ring, available on all Cutlass Supreme Classic, Cutlass Cruiser and Cutlass Ciera models except Ciera International Series.

**CENTER ROW, LEFT TO RIGHT...** Aluminum-Styled Wheel (N78) included on Cutlass Calais International Series and

Cutlass Ciera International Series and with FE3 suspension and performance tire (Except Cruisers). Available on all Cutlass Ciera and Cutlass Cruiser models. Choice of Silver or Gold trim. Simulated Wire Wheel Disc with Lock (N91) available on all Cutlass Cruiser and Cutlass Ciera models except Ciera International Series. Aluminum-Styled Wheel (N78) available on all Cutlass Supreme Classic models. Super Stock Wheel (N67) Color-Coordinated with Stainless Steel Trim Ring, available on all Cutlass Supreme Classic, Cutlass Cruiser and Cutlass Ciera models except Ciera International Series. Aluminum-Styled Wheel (PD8) included on Cutlass Calais International Series and

with FE3 suspension. Available on Firenza and Cutlass Calais models and includes a performance tire, plus leather-wrapped sport steering wheel. Choice of Silver or Gold trim on Calais models.

**BOTTOM ROW, LEFT TO RIGHT...** Super Stock Chrome Wheel (N66) available on all Cutlass Supreme Classic models. Deluxe Wheel Disc standard on all Cutlass Supreme Classic models. Deluxe Wheel Disc standard on all Cutlass Cruiser and Cutlass Ciera models except Ciera International Series. Simulated Wire Wheel Disc with Lock (N91) available on all Cutlass Supreme Classic models.

### DELCO SOUND SPECIALIST RADIOS

	Firenza	Cutlass Calais	Cutlass Calais International Series	Cutlass Ciera/International Series	Cutlass Cruiser	Cutlass Supreme Classic
Radio, Delco ETR AM/FM Stereo with Seek-Scan and Digital Display Clock—includes Dual Rear Speakers with Extended Range	S	—	—	—	—	—
Radio, Delco ETR AM/FM Stereo with Seek-Scan and Digital Display Clock—includes Dual Rear Speakers and Fixed Mass Fender Antenna	—	S	—	S	S	S
UMR Radio, Delco ETR AM/FM Stereo with Seek-Scan, Auto-Reverse Cassette and Digital Display Clock—includes Dual Rear Speakers with Extended Range	A	A	S	A	A	A
UX1 Radio, Delco ETR AM Stereo/FM Stereo with Seek-Scan, Auto-Reverse Cassette with Music Search, Graphic Equalizer and Digital Display Clock—includes Dual Rear Speakers with Extended Range	—	A	A	A	A	A

S=Standard equipment A=Available equipment —=Not available \*\*Receives C-Quam™ AM stereo broadcasts. Most AM stereo stations across the country broadcast in C-Quam™ but some do not. Check with your local stations for compatibility in your area.

## AFFORDABLE NEW OPTION PACKAGES TO PERSONALIZE YOUR OLDS.

FIRENZA OPTION PACKAGES (Packages may be ordered cumulatively or exclusively. All Orders must include at least ONE Package)		FIRENZA					
		1SP	1SR	1SS	1ST	1SU	1SX
Windows, Soft-Ray Limited			*	*	*	*	*
Steering, Power			*	*	*	*	*
Seat Adjuster, 4-Way Manual—Driver Side			*	*	*	*	*
Floor Mats, Auxiliary Front and Rear Carpet			*	*	*	*	*
Moldings, Rocker Panel—Black			*	*	*	*	*
Accent Stripes, Body			*	*	*	*	*
Armrest, Fold-Down, Console			*	*	*	*	*
Door Locks, Power—includes Tailgate Lock Release on Cruiser			*	*	*	*	*
Windows, Power Side (Except Rear Quarter Vents on Cruiser)			*	*	*	*	*
Wiper System, Pulse			*	*	*	*	*
Cruise Control, Electronic with Resume and Acceleration features			*	*	*	*	*
Steering Wheel, Tilt-Away			*	*	*	*	*
Convenience Group—includes Under-Hood and Interior Courtesy Lamps, Visor Vanity Mirror, Headlamp-On			*	*	*	*	*
Steering Wheel, Leather-Wrapped, Sport			*	*	*	*	*
Wheels, Aluminum Styled 14" with Argent Spokes—includes Tires, P195/70R14 Ride Steel-Belted Radial-Ply, Blackwall—All-Season Cluster, Instrument Panel Rallye—includes tachometer, Trip Odometer, Voltmeter, Temperature and Oil Pressure Gages			*	*	*	*	*
Level III Ride and Handling Suspension System—includes special suspension components, plus Steering Wheel, Leather-Wrapped, Sport, Wheels, Aluminum Styled 14" with Argent Spokes, Tires, P215/60R14 Performance Steel-Belted Radial-Ply, Blackwall—All-Season Cluster, Instrument Panel Rallye—includes tachometer, Trip Odometer, Voltmeter, Temperature and Oil Pressure Gages			*	*	*	*	*

CUTLASS CALAIS OPTION PACKAGES (All Orders must include only ONE Option Package)		CALAIS					CALAIS SL					CALAIS International Series				
		1SA	1SB	1SC	1SD	1SE	1SF	1SA	1SB	1SC	1SD	1SE	1SF	1SA	1SB	1SC
BW2 Moldings, Body Side Deluxe, Bright with Gray Inserts		*	*	*	*	*	*	*	*	*	*	*	*	*	*	*
K34 Cruise Control, Electronic with Resume and Acceleration features		*	*	*	*	*	*	*	*	*	*	*	*	*	*	*
N33 Steering Wheel, Tilt-Away		*	*	*	*	*	*	*	*	*	*	*	*	*	*	*
B37 Floor Mats, Auxiliary Front and Rear Carpet		*	*	*	*	*	*	*	*	*	*	*	*	*	*	*
G04 Wiper System, Pulse		*	*	*	*	*	*	*	*	*	*	*	*	*	*	*
TR9 Convenience Group—includes Under-Hood and Interior Courtesy Lamps, Visor Vanity Mirror		*	*	*	*	*	*	*	*	*	*	*	*	*	*	*
A31 Windows, Power Side		*	*	*	*	*	*	*	*	*	*	*	*	*	*	*
AH3 Seat Adjuster, 4-Way Manual, Bucket Seat—Driver Side		*	*	*	*	*	*	*	*	*	*	*	*	*	*	*
AU3 Door Locks, Power		*	*	*	*	*	*	*	*	*	*	*	*	*	*	*
A90 Trunk-Lid Lock Release, Power		*	*	*	*	*	*	*	*	*	*	*	*	*	*	*
AC3 Seat Adjuster, 6-Way Power, Bucket Seat—Driver Side		*	*	*	*	*	*	*	*	*	*	*	*	*	*	*
D68 Mirrors, Color-Coordinated Outside, Remote Control, Driver and Passenger Side		*	*	*	*	*	*	*	*	*	*	*	*	*	*	*

CUTLASS CIERA OPTION PACKAGES (All Orders must include only ONE Option Package)		CIERA					CIERA SL/BROOKHAM					CIERA International Series		
		1SA	1SB	1SC	1SD	1SE	1SA	1SB	1SC	1SD	1SE	1SA	1SB	1SC
K34 Cruise Control, Electronic with Resume and Acceleration features		*	*	*	*	*	*	*	*	*	*	*	*	*
N33 Steering Wheel, Tilt-Away		*	*	*	*	*	*	*	*	*	*	*	*	*
B34 Floor Mats, Auxiliary Front Carpet		*	*	*	*	*	*	*	*	*	*	*	*	*
B35 Floor Mats, Auxiliary Rear Carpet		*	*	*	*	*	*	*	*	*	*	*	*	*
G04 Wiper System, Pulse		*	*	*	*	*	*	*	*	*	*	*	*	*
AU3 Door Locks, Power		*	*	*	*	*	*	*	*	*	*	*	*	*
A31 Windows, Power Side		*	*	*	*	*	*	*	*	*	*	*	*	*
TR9 Convenience Group—includes Under-Hood and Trunk Lamps, Inside Day-Night Mirror with Dual Reading Lamps, and Visor Vanity Mirror		*	*	*	*	*	*	*	*	*	*	*	*	*
A61 Seat Adjuster, 6-Way Power, Divided Bench Seat—Driver Side		*	*	*	*	*	*	*	*	*	*	*	*	*
D68 Mirrors, Color-Coordinated Outside, Remote Control—Driver and Passenger Side		*	*	*	*	*	*	*	*	*	*	*	*	*
AC3 Seat Adjuster, 6-Way Power, Bucket Seat—Driver Side		*	*	*	*	*	*	*	*	*	*	*	*	*

CUTLASS SUPREME CLASSIC OPTION PACKAGES (All Orders must include only ONE Option Package)		CLASSIC					CLASSIC BROOKHAM				
		1SA	1SB	1SC	1SD	1SE	1SA	1SB	1SC	1SD	1SE
K34 Cruise Control, Electronic with Resume and Acceleration features		*	*	*	*	*	*	*	*	*	*
N33 Steering Wheel, Tilt-Away		*	*	*	*	*	*	*	*	*	*
G04 Wiper System, Pulse		*	*	*	*	*	*	*	*	*	*
D35 Mirrors, Color-Coordinated Outside, Driver Side—Remote Control, Passenger Side—Manual		*	*	*	*	*	*	*	*	*	*
A31 Windows, Power Side		*	*	*	*	*	*	*	*	*	*
B34 Floor Mats, Auxiliary Front Carpet		*	*	*	*	*	*	*	*	*	*
B35 Floor Mats, Auxiliary Rear Carpet		*	*	*	*	*	*	*	*	*	*
TR9 Convenience Group—includes Under-Hood, Trunk and Interior Courtesy Lamps, Visor Vanity Mirror		*	*	*	*	*	*	*	*	*	*
A61 Seat Adjuster, 6-Way Power, Divided Bench Seat—Driver Side		*	*	*	*	*	*	*	*	*	*
A16 Reclining Seat Back, Passenger Side—Manual		*	*	*	*	*	*	*	*	*	*
A90 Trunk-Lid Lock Release, Power		*	*	*	*	*	*	*	*	*	*
AU3 Door Locks, Power		*	*	*	*	*	*	*	*	*	*

CUTLASS CRUISER OPTION PACKAGES (All Orders must include only ONE Option Package)		CRUISER					CRUISER BROOKHAM				
		1SA	1SB	1SC	1SD	1SE	1SA	1SB	1SC	1SD	1SE
K34 Cruise Control, Electronic with Resume and Acceleration features		*	*	*	*	*	*	*	*	*	*
N33 Steering Wheel, Tilt-Away		*	*	*	*	*	*	*	*	*	*
G04 Wiper System, Pulse		*	*	*	*	*	*	*	*	*	*
A31 Windows, Power Side		*	*	*	*	*	*	*	*	*	*
B34 Floor Mats, Auxiliary Front Carpet		*	*	*	*	*	*	*	*	*	*
B35 Floor Mats, Auxiliary Rear Carpet		*	*	*	*	*	*	*	*	*	*
TR9 Convenience Group—includes Under-Hood, Trunk and Interior Courtesy Lamps, Visor Vanity Mirror		*	*	*	*	*	*	*	*	*	*
A61 Seat Adjuster, 6-Way Power, Divided Bench Seat—Driver Side		*	*	*	*	*	*	*	*	*	*
AU3 Door Locks, Power—includes Tailgate Lock Release		*	*	*	*	*	*	*	*	*	*
D68 Mirrors, Color-Coordinated Outside, Remote Control, Driver and Passenger Side		*	*	*	*	*	*	*	*	*	*

NOTE: Package 1SX available only on Coupe and Sedan. (N.A. with Package 1SW)





## STANDARD AND AVAILABLE EQUIPMENT

### COMFORT/CONVENIENCE FEATURES (Cont.)

#### N33 Steering Wheel, Tilt-Only

Available on: A1 A2 A3 A4 A5 A6 A7 A8 A9

#### T89 Convenience Group—includes Under-Hood, Interior, Trunk Lamps and Visor Vanity Mirror (Also Headlamp-On for Firenza)

Available on: A1 A2 A3 A4 A5 A6 A7 A8 A9

#### T89 Convenience Group—includes Under-Hood, Trunk and Interior Lamps, Inside Day-Night Mirror with Dual Reading Lamps, Visor Vanity Mirror

Available on: A1 A2 A3 A4 A5 A6 A7 A8 A9

#### UM6 Radio, Delco ETR AM/FM Stereo with Seek-Scan, Auto-Reverse Cassette and Digital Display Clock—includes Dual Rear Speakers with Extended Range (Dual Rear Speakers on Firenza models)

Available on: A A A S A A A A A A A A A A

#### UX1 Radio, Delco ETR AM Stereo/FM Stereo with Seek-Scan, Auto-Reverse Cassette with Music Search, Graphic Equalizer and Digital Display Clock—includes Dual Rear Speakers with Extended Range

Available on: A A A A A A A A A A A A A A

S—Standard equipment A—Available equipment  
—Also available in an option package

#### U21 Cluster, Instrument Panel Rallye—includes Tachometer, Trip Odometer, Voltmeter, Temperature and Oil Pressure gauges (Trip Odometer Standard on Calais Models)

Available on: A1 A2 A3 A4 A5 A6 A7 A8 A9

#### U48 Monitor, External Lamps, Front and Rear

Available on: A1 A2 A3 A4 A5 A6 A7 A8 A9

#### U51 Information System, Driver—provides digital readout (English/metric) for Fuel Economy, instantaneous and average, Range and Fuel Used; Time and Elapsed Time, plus Average Miles-Per-Hour, Date, Estimated Time of Arrival and Total Distance to Destination. Also provides automated service reminder showing Estimated Oil Life remaining. Digital gauge information for Tachometer, Voltmeter and Coolant Temperature

Available on: A1 A2 A3 A4 A5 A6 A7 A8 A9

#### V3N Column Shift, for Automatic Transmission

Available on: A A A A A1 A2

#### V55 Luggage Carrier, RoofTop—Chrome—includes Window Air Deflector, Rear

Available on: A1 A2

#### V56 Luggage Carrier, Deck Lid—Black—includes High-Level Stop Lamp

Available on: A1 A2 A3 A4 A5 A6 A7 A8 A9

#### V58 Luggage Carrier, Deck Lid—Chrome—includes High-Level Stop Lamp

Available on: A1 A2 A3 A4 A5 A6 A7 A8 A9

—Available only when other options are ordered/desired. See your dealer for details. —Available only in an option package.  
—Reserve "Quantity" All series brochures. Most AM stereo stations across the country broadcast in "Quantity" full-time or not. Check with your local stations for compatibility in your area.

### STANDARD EXTERIOR COLORS (Actual color paint chips available. Ask your salesperson.)

- 11 White ●, ○
- 12 Silver Metallic ●, ○
- 13 Platinum Metallic ▲
- 14 Black Metallic ▲
- 15 Medium Gray Metallic ●, ○
- 19 Black ●, ○
- 22 Light Sapphire Blue Metallic ▲
- 25 Light Teal Blue Metallic ●
- 26 Light Sapphire Blue Metallic ●
- 27 Medium Sapphire Blue Metallic ▲

- 29 Dark Sapphire Blue Metallic ■
- 31 Dark Teal Blue Metallic ○
- 40 White ●
- 52 Copper Beige ▲
- 57 Light Beechwood Metallic ●, ■
- 58 Light Chestnut Metallic ○
- 59 Dark Beechwood Metallic ■
- 62 Light Beechwood Metallic ▲
- 70 Carmine Red ●
- 71 Medium Red Metallic ○

- 72 Medium Garnet Red Metallic ▲
- 75 Medium Garnet Red Metallic ●
- 76 Dark Garnet Red Metallic ▲
- 78 Medium Rosewood Metallic ■
- 79 Burgundy Metallic ○
- 87 Medium Gray Metallic ▲
- 13 Platinum Metallic/87 Med. Gray Metallic ○
- 14 Black Metallic/13 Platinum Metallic ▲

- 15 Medium Gray Metallic/12 Silver Metallic ○
- 19 Black/12 Silver Metallic ○
- 40 White/87 Medium Gray Metallic ○
- 72 Medium Garnet Red Metallic ■
- 13 Platinum Metallic ○
- 75 Medium Garnet Red Metallic/12 Silver Metallic ○

#### Two-tone paint schemes (primary color/secondary color)

- 13 Platinum Metallic/87 Med. Gray Metallic ○
- 14 Black Metallic/13 Platinum Metallic ▲

### AVAILABLE EXTERIOR COLORS

WM3 Calais Sport Appearance Package—features a special paint scheme (D68) with primary color available in all Calais Calais exterior colors and lower accent

in low-gloss black. Includes accent stripe, Bumpers, bumper rub strips, body side and wheel-opening moldings, door handles, lock cylinders, grille, headlamp doors are black. ▲

### KEY

- Firenza
- ▲ Calais/Calais SL
- Calais Calais International Series

- Calais Ciera/Ciera Brougham, Calais Cruiser/Cruiser Brougham
- ▲ Calais Calais International Series
- Calais Supreme Classic/Classic Brougham

### 1988 OLDSMOBILE MODEL LINEUP

**VOLUME I**  
Toronto Coupe  
Toronto Sedan  
Oldsmobile Touring Sedan  
Ninety-Eight Regency Brougham Sedan  
Ninety-Eight Regency Sedan  
Cruiser Cruiser 3-Seat Wagon  
Delta 88 Royale Brougham Sedan

Delta 88 Royale Brougham Coupe  
Delta 88 Royale Sedan  
Delta 88 Royale Coupe

**VOLUME II**  
Calais Calais International Series Coupe  
Calais Calais International Series Sedan  
Calais Calais SL Coupe

Calais Calais SL Sedan  
Calais Calais Coupe  
Calais Calais Sedan  
Calais Ciera International Series Coupe  
Calais Ciera International Series Sedan  
Calais Ciera SL Coupe  
Calais Ciera Brougham Sedan  
Calais Ciera Coupe

Ciera Ciera Sedan  
Cruiser Cruiser Brougham 2-Seat Wagon  
Cruiser Cruiser 2-Seat Wagon  
Supreme Classic Brougham Coupe  
Supreme Classic Coupe  
Firenza Coupe  
Firenza Sedan  
Firenza Cruiser 2-Seat Wagon

The 1988 Oldsmobiles are carefully designed and built to resist corrosion, so the application of additional rustproofing is neither

necessary or required. Oldsmobile's confidence in its extensive anti-corrosion protection is reflected in a new vehicle warranty

which includes 6-year/100,000-mile rust-through protection. See your dealer for terms and conditions of the limited warranty.

PRINTED IN U.S.A./87

**Important—A word about this catalog:** We have tried to make this catalog as comprehensive and factual as possible, and we hope you find it helpful. However, since the time of printing, some of the information you will find here may have been updated. Also, some of the equipment shown or described throughout this Olds catalog is available at extra cost. Your dealer has details; before ordering, you should be brought up-to-date. The right is reserved to make changes at any time, without notice, in prices, colors, materials, equipment, specifications and models. Check with your Olds dealer for complete information.

**A word about engines:** Oldsmobiles are equipped with engines produced by GM or suppliers to GM worldwide.

**A word about assembly, components and optional equipment in these Oldsmobile products:** The Oldsmobiles described in this catalog are assembled at facilities operated by General Motors or GM of Canada. These vehicles incorporate thousands of different components produced by car groups or various component divisions of General Motors and by various suppliers worldwide to GM. From time to time during the manufacturing process, it may be necessary, in order to meet public demand for particular vehicles or equipment, or to meet federally mandated emissions, safety and fuel economy requirements, or for other reasons, to produce Oldsmobile products with different components or differently

sourced components than initially scheduled. All such components have been approved for use in Oldsmobile products and will provide the quality performance associated with the Oldsmobile name. With respect to extra-cost optional equipment, make certain you specify the type of equipment you desire on your vehicle when ordering it from your dealer. **Some options may be unavailable when your car is built. Your dealer receives advice regarding current availability of options. You may ask your dealer for this information. GM also requests your dealer to advise you if the option you ordered is unavailable. We suggest that you verify that your car includes the optional equipment you ordered, or if there are changes, that they are acceptable to you.**

**Occupant protection features:** Automatic safety belt system for driver and right front passenger on Calais. Manual lap/shoulder safety belts for driver and right front passenger, driver side includes visual and audible warning system on all other models. Manual lap safety belts, center front/rear seat positions, where applicable. Energy-absorbing steering column. Energy-absorbing instrument panel. Energy-absorbing seat back tops, front. Laminated safety windshield glass. Safety interlocking door latches. Side-guard door beam. Passenger-guard inside door lock handles. Inertia-latching, folding front seat backs on two-door models. Safety armrests. Head restraints, driver and right front

passenger (adjustable).  
Accident avoidance features: Side marker lights and reflectors. Parking lamps that illuminate with headlamps. Four-way hazard warning flasher. Back-up lights. Center high-mounted stop lamp. Directional signal control with lane change feature. Windshield defroster, washer and multi-speed wipers. Inside rearview mirror. Outside rearview mirrors (left side with remote control). Brake system with dual master cylinder and warning light. Starter safety switch. Dual action hood latch. Low-glare finish on inside windshield moldings, wiper arms and blades, metallic steering wheel surfaces. Illuminated heater and defroster controls. Illuminated windshield wiper and washer controls on Calais. Tires with built-in tread-wear indicators.

**Theft deterrence features:** Audible reminder for ignition key removal. Theft-deterrent steering column lock. Visible vehicle identification number.

**A word about updated service information:** Oldsmobile regularly sends its dealers useful service bulletins about Oldsmobile products. Oldsmobile monitors product performance in the field. We then prepare bulletins for servicing our product better. Now you can get these bulletins, too. Ask your dealer. To get ordering information, call toll free 1-800-551-4123.

ALONG WITH YOUR NEW OLDS—WELL START YOU OFF WITH A FULL TANK OF GAS, SPECIAL KEYS, A PORTFOLIO OF USEFUL INFORMATION AND A GREAT FEELING OF SATISFACTION.

This literature has been produced to provide you with as much extensive information as possible about the 1988 Oldsmobiles. If you have any questions or require further information, visit your Oldsmobile dealer. He has voluminous additional information and specifications available for your use.

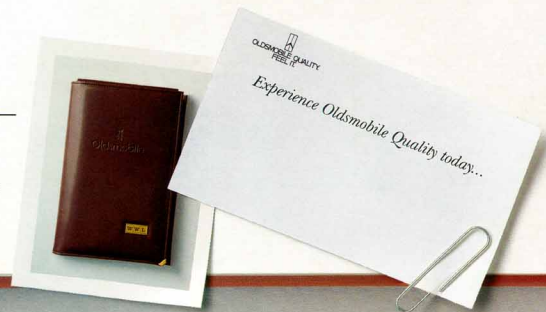



OLDSMOBILE QUALITY.  
FEEL IT.