

*congratulations
on your choice
but . . .
have you overlooked
anything?*

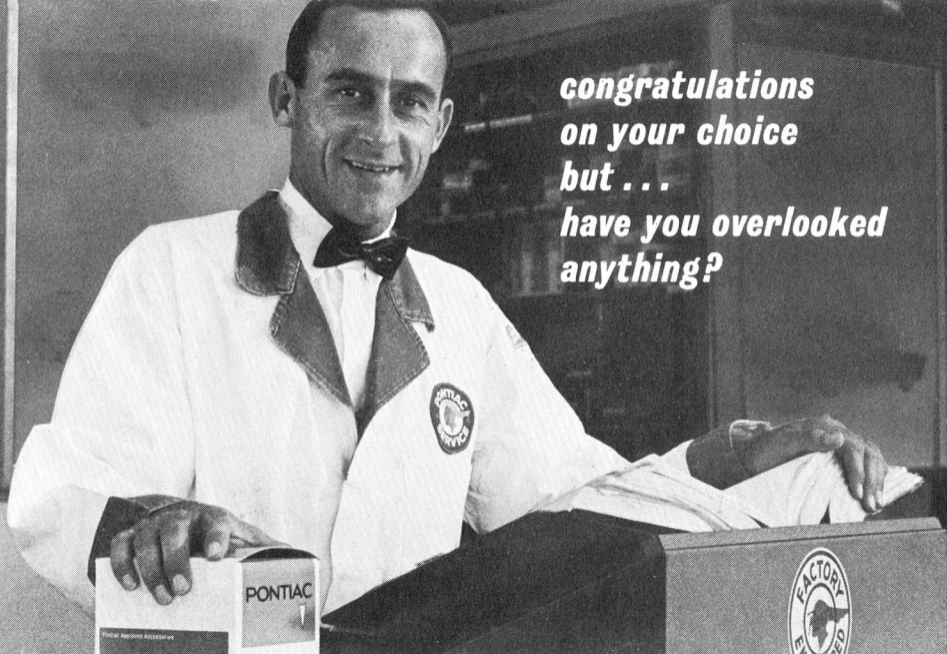

is there an accessory you wish you'd ordered?

You still can with a few exceptions. Your Pontiac dealer has a wide range of accessories built specifically for your car.

They're designed to satisfy the desire for that something extra in driving comfort and convenience many of us want.

Look through this booklet. Anything you see here, your Pontiac dealer has . . . or can get in a jiffy. Ask him.

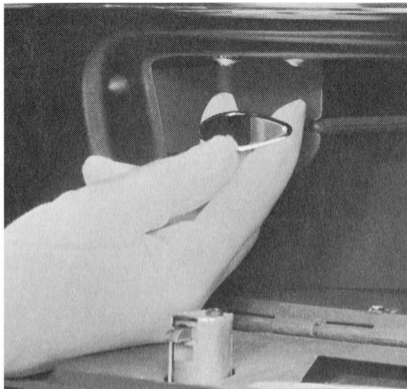

Deck lid release

Lets you open trunk from driver's seat.

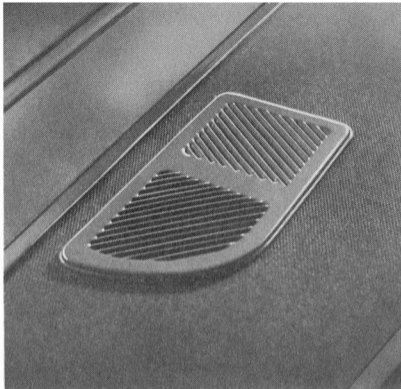

Rear window defogger

Blower under rear package shelf directs air through grille to rear window for clearer view. (Not available on Station Wagons or convertibles.)

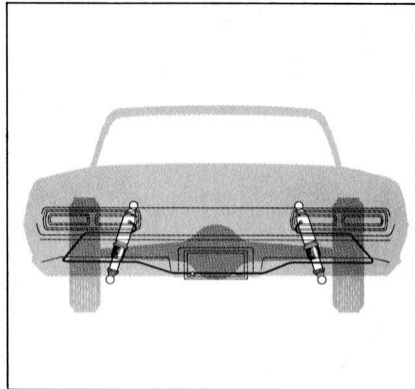

Super lift shock absorbers

Helps maintain level ride when trunk or trailer loads are extra heavy. Adjustable air spring is built into rear shock absorber. Tire-type air-filler valve.

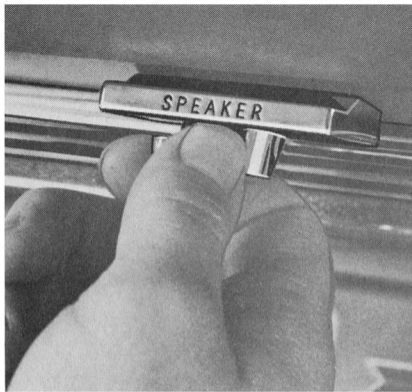

Separa-Phonic Rear Speaker

Brilliant tone and depth control. 3-step switch lets you play front, rear or both speakers.

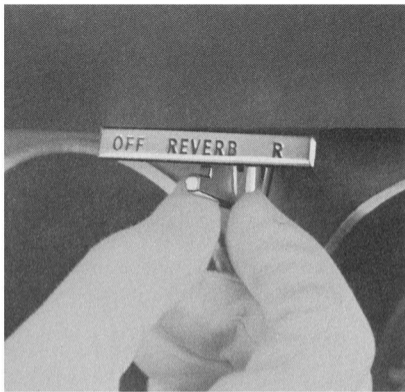

Verbra-Phonic Rear Speaker System

Brilliant tone reverberates throughout car providing a sound chamber effect. 3-step switch lets you play through front, rear or both speakers. All models except Station Wagons and Tempest Custom, Le Mans and GTO Convertibles.

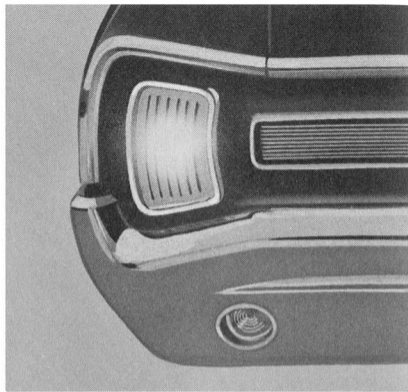

Traffic hazard flasher

Flip switch and parking and stop lamps will blink simultaneously. Excellent emergency precaution if required on highway.

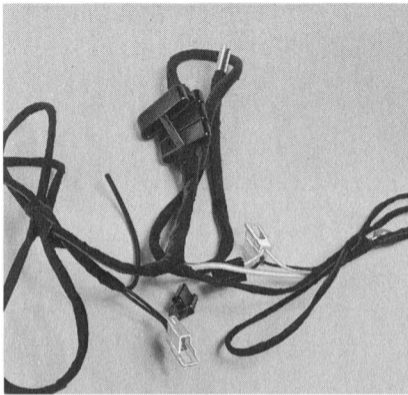

Trailer wiring harness

Consists of an easily adaptable harness to bridge the tail and signal light systems of the car and trailer.

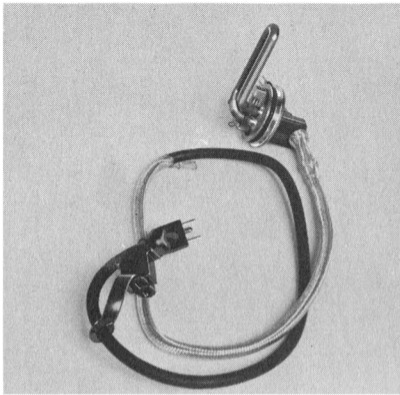

Engine block heater

Electric pre-heater for engine coolant helps provide fast starts, quick heater action in severe cold. Overnight, single unit raises engine coolant from 0°F. to 50°F., dual unit to about 90°F. Plugs into cord from standard house outlet.

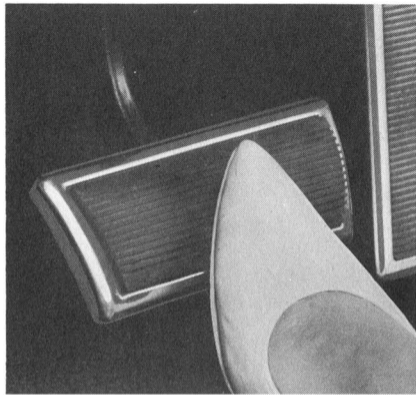

Power brakes

Positive braking with light touch of toe, but feel of control is still there.

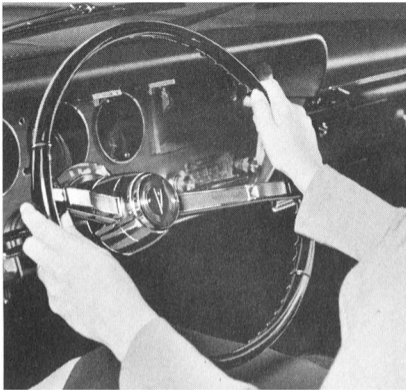

Power steering

Drive and park with almost effortless ease, yet feel of control is still there.

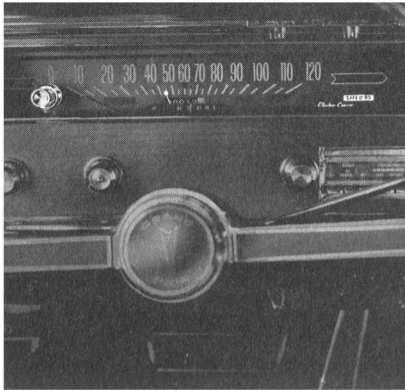

Electro-cruise

Automatically maintains driver-selected car speed. Also gives low fuel warning. Available only with Turbo Hydra-Matic on Catalina, Ventura, 2+2, Star Chief EXECUTIVE, Bonneville and Grand Prix.

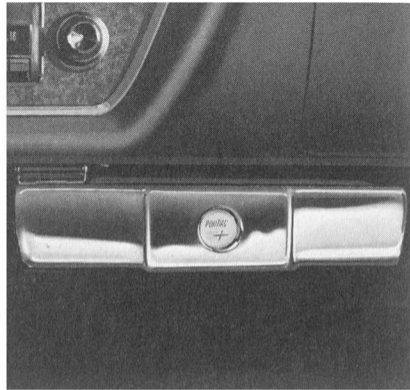

Tissue dispenser

Holds regular size Kleenex box. Mounts under instrument panel. Swings out for use, back when not needed. (N.A. with Air Conditioning.)

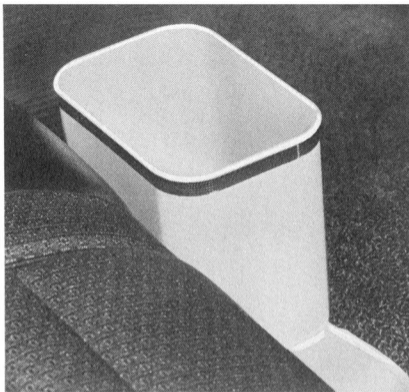

Litter container

Available in red, blue, black or beige to harmonize with car interior. Clings to transmission tunnel, weighted to prevent tipping. Easily removed for emptying.

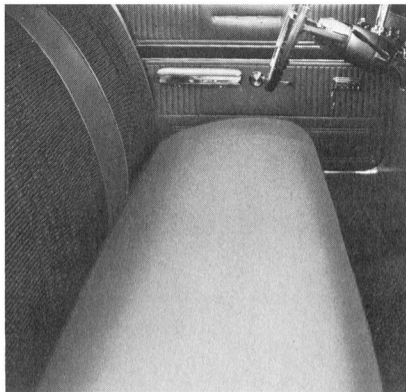

Cushion topper

Sleek rayon material with foam backing covers seat cushions. Available in 6 different colors to match interior.

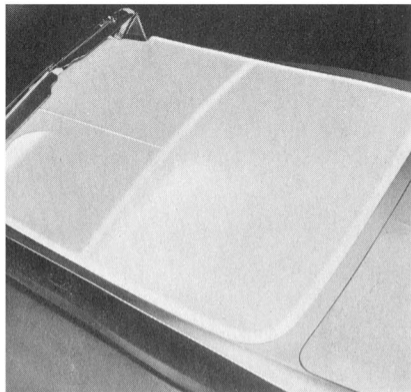

Tonneau cover

Protects convertible interior when top is down. Sturdy vinyl cover snaps on or off in a jiffy. Zippered opening for driver.

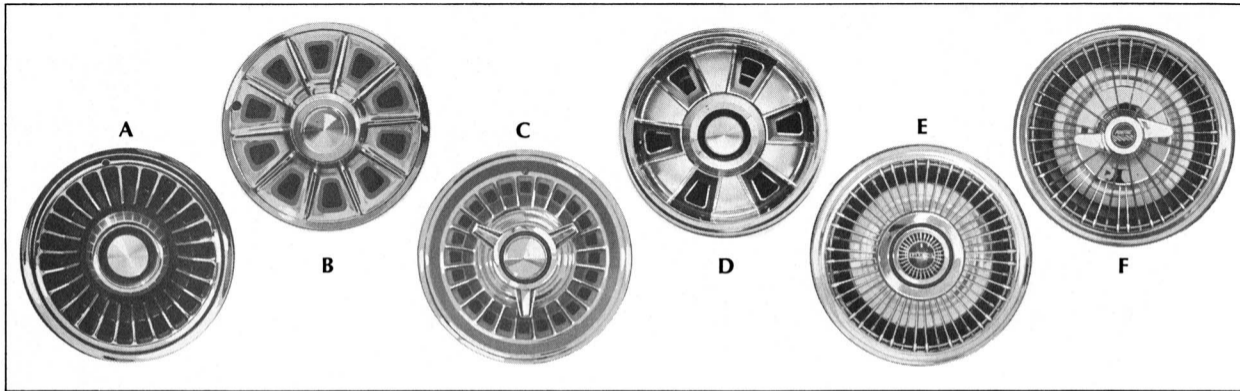

Wheel Discs

A. Pontiac deluxe wheel discs

B. Tempest deluxe wheel discs

C. Pontiac custom wheel discs

D. Tempest custom wheel discs

E. Pontiac wire wheel discs

F. Tempest wire wheel discs

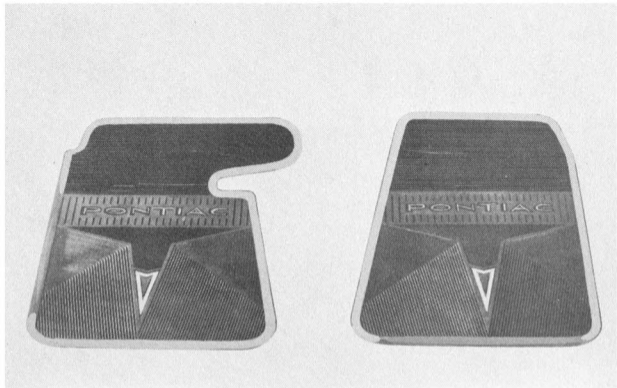

Front floor mats (pair)

Protect carpet from wear and dirt. Easily removed. Available in 8 colors to harmonize with interiors.

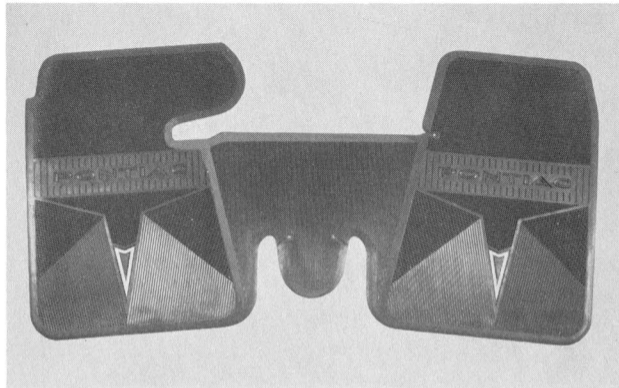

Full width floor mat

Extends over transmission tunnel. Available in 8 colors to complement interiors.

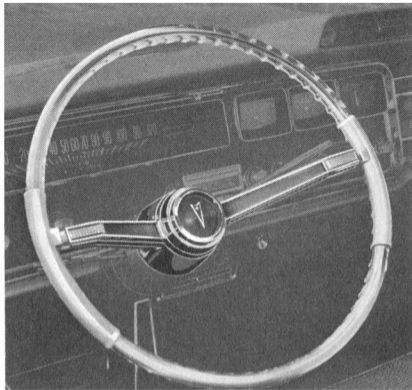

Deluxe steering wheel

Horn activator bar recessed into the two wheel spokes. Standard on Ventura, 2+2, Star Chief EXECUTIVE, Bonneville, Grand Prix; part of Decor Group on Catalina.

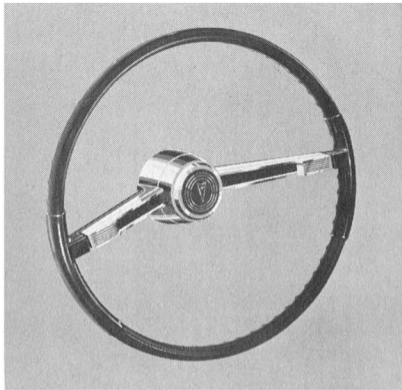

Deluxe Steering Wheel

Horn activator bar recessed into each of the two wheel spokes. Standard on Tempest Custom, Le Mans, GTO, optional on Tempest.

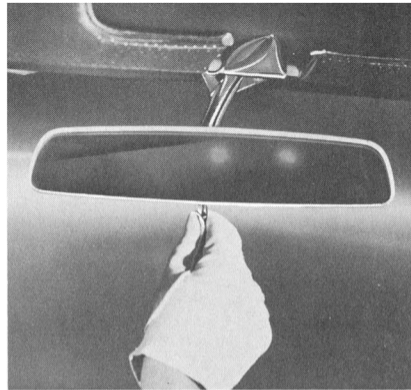

Inside non-glare mirror

Special finger knob permits easy adjustment to non-glare or nighttime driving position.

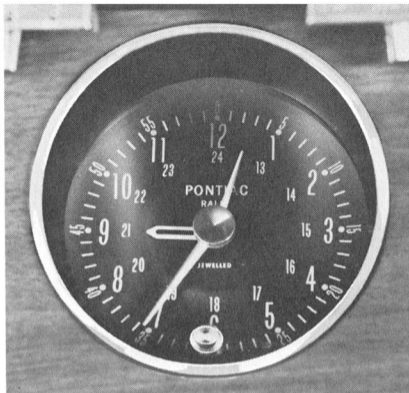

Electric clock

Features sweep second hand and built-in automatic self-regulator. Illuminated at night. Optional at extra cost on Tempest, Tempest Custom, Le Mans, GTO, and Catalinas. (Tempest clock shown.)

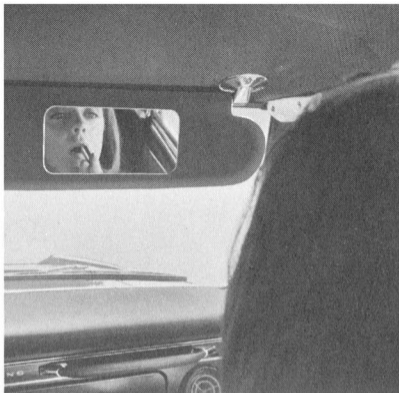

Visor vanity mirror

Mounts on back of visor. Out of sight when not in use.

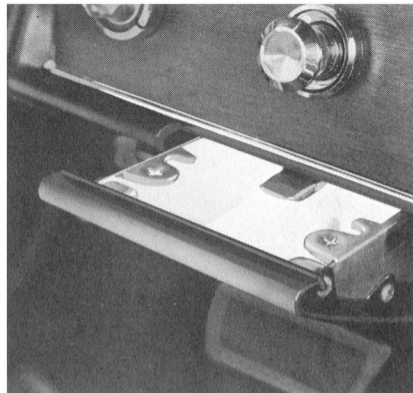

Ash tray lamp

For all Tempest, Tempest Custom, Le Mans and GTO models. Glows automatically when parking lamps or head lamps go on. Ash tray or lighter opening easily seen when in use.

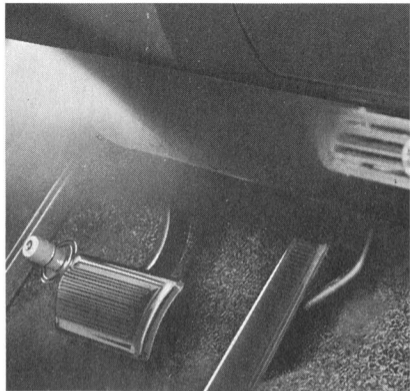

Courtesy lamp

Flashes on when front door is opened. Manually operated by turning head lamp switch knob on instrument panel. For all Tempest, Tempest Custom, Le Mans and GTO models. Standard on convertible.

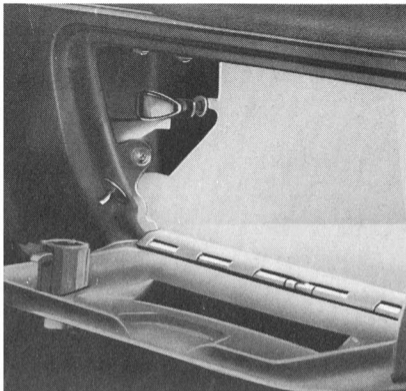

Glove box lamp

Lights automatically when glove compartment door is opened. For all Tempest, Tempest Custom, Le Mans and GTO models.



Luggage lamp

Turns on automatically when trunk is lifted (sedans and coupes only). For all Tempest, Tempest Custom, Le Mans and GTO models.

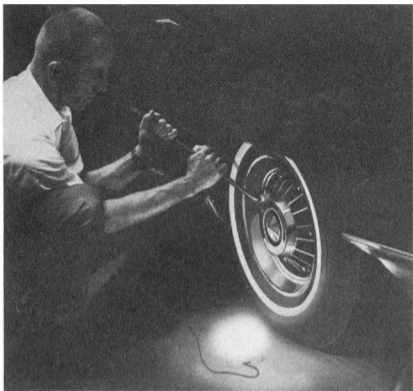

Underhood utility lamp

Has about 17 feet of self-storing extension cord. Ideal for emergency repairs at night.

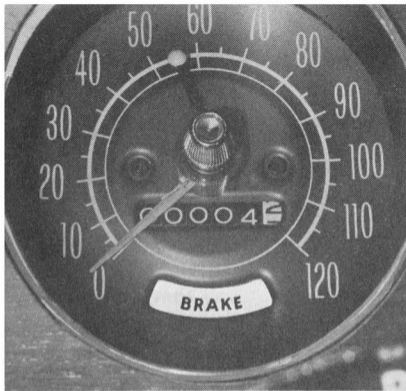

Parking brake warning lamp

Mounted on instrument panel. Shows red light when ignition is on and parking brake is set. For all Tempest, Tempest Custom, Le Mans and GTO models.

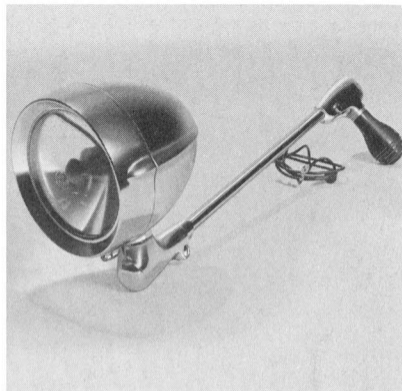

Spot lamp

Easily controlled from inside of car. Completely chromed for long-wearing durability. Available only on Catalina, Ventura, 2+2, Star Chief EXECUTIVE, Bonneville and Grand Prix.

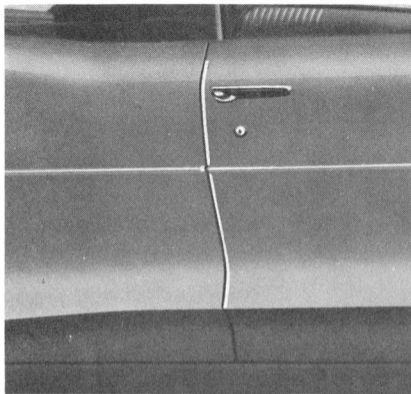

Door edge guards

Narrow stainless steel strips help prevent nicks and scratches on door edges.

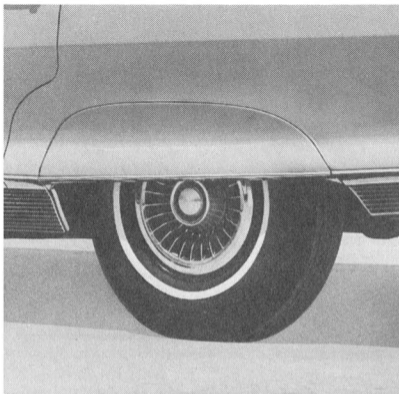

Fender skirts

Optional on Catalina, 2+2 and Star Chief EXECUTIVE. Standard on Ventura, Bonneville and Grand Prix. Enhances over-all appearance, gives body sides continuous flowing lines. Not available on Tempest, Tempest Custom, Le Mans, GTO or Station Wagons.

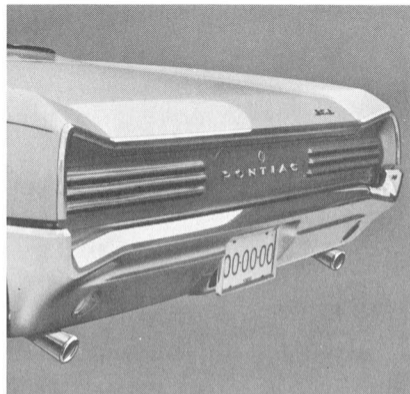

Exhaust tail pipe extensions

Two bright metal tail pipe extensions for dual exhaust system, and one for extension pipe for 4-BBL overhead cam engine.



Vent shades

Fit snugly over top of side windows. Windows can be slightly open, yet vent shades protect from rain. Not available on hardtops and convertibles.



Gas cap lock

Station Wagons only. Prevents fuel thefts. Separate key.

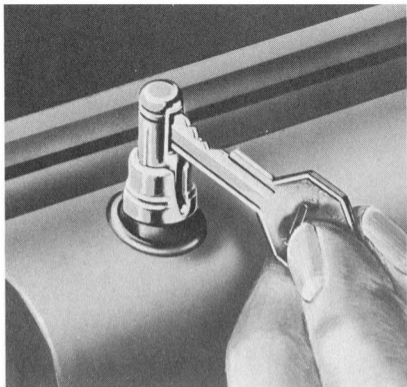

Rear door safety locks

4-door models only. When lock button is pushed down, rear doors cannot be opened without inserting key into lock button.

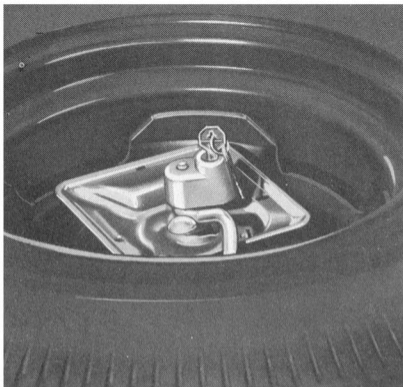

Spare tire lock

Prevents theft of spare tire and wheel.



Compass

Has special compensator for car use. Illuminated dial.



Ventilated cushions

Special coil-spring construction allows air to circulate between passenger and seat. Makes summer driving more comfortable.

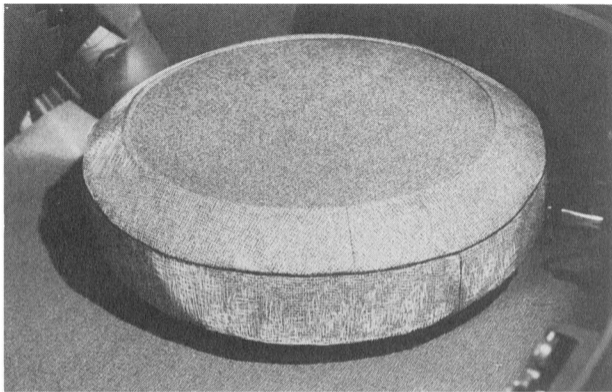

Spare tire cover

Protects luggage and other articles. Slips on and off. Standard on Star Chief EXECUTIVE, 2+2, Bonneville and Grand Prix. Optional at extra cost on all other models. Not available on Station Wagons.

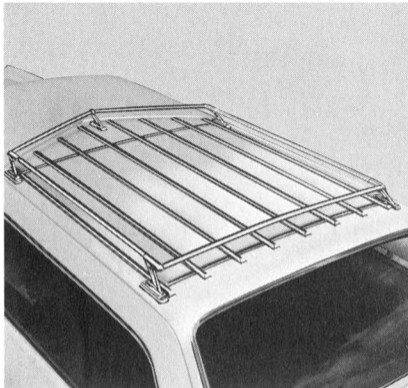

Chrome luggage carrier

Permanently installed on Station Wagons. Handy side rails provide luggage tie-down.

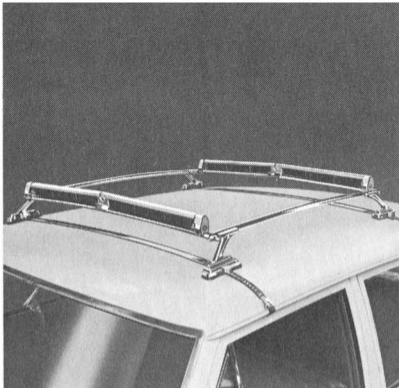

Ski carrier

Holds 6 pairs of skis. Removable for easy storage.

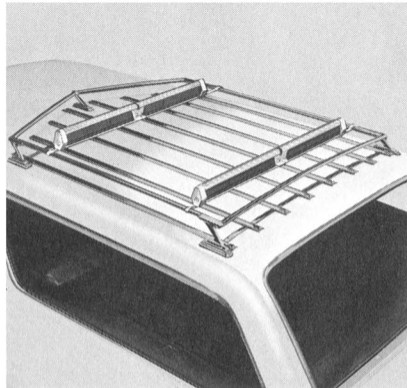

Ski carrier adapter

Converts Station Wagon luggage carrier into ski rack.



Luggage carrier and cover (Karpak)

Water and dust-resistant fabric protects luggage. Side opening can be locked. Available all models. Can be used on rear deck lid of convertibles. Quickly removable when not in use.

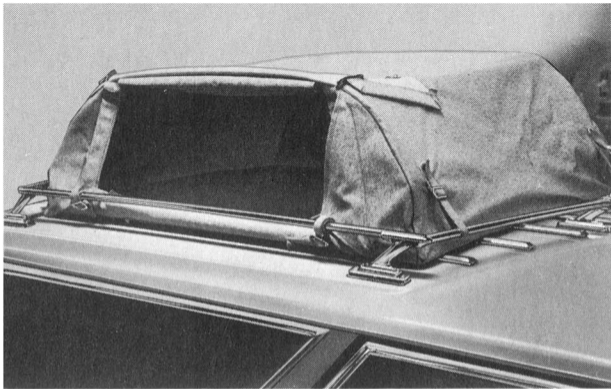

Luggage carrier cover (Rakpak)

For use with Station Wagon luggage carrier. Similar to Karpak described at left. Cover folds flat when not in use. Size 38 x 46 x 14.

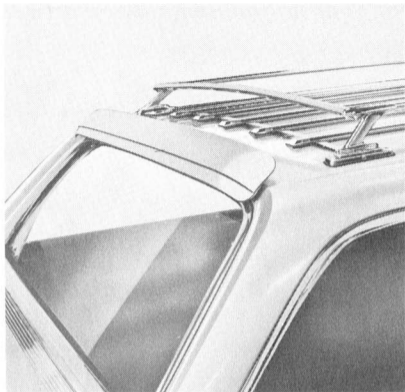

Station Wagon wind deflector

Horizontal metal vane deflects air-stream down over rear window, helps keep it clean.

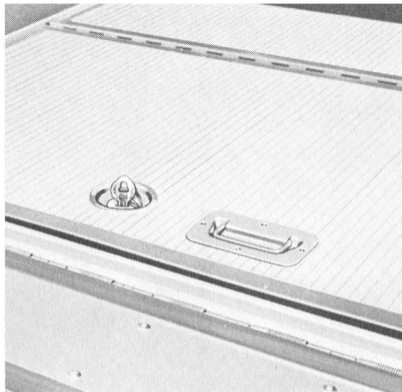

Station Wagon luggage lock

Keeps valuables safe in rear load floor compartment. 2-seat Catalina Station Wagon only.

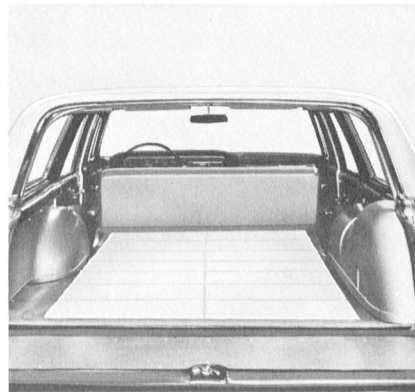

Utility pad

Durable, resilient, coated fabric. Wonderful for picnics and beach. Available in two-tone combinations of gray and aqua, mahogany and green or yellow and red. Size 77 $\frac{1}{2}$ " length, 42 $\frac{1}{2}$ " width, $\frac{3}{4}$ " thickness.

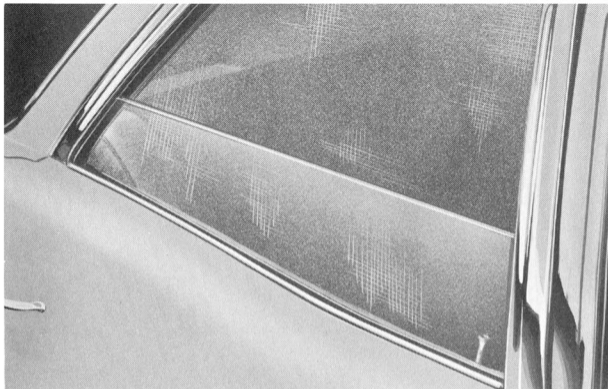

Station Wagon screen (rear door window)

Heavy gauge, long wearing aluminum. Attaches permanently to inner window frames. Windows open independently. Sold in pairs.

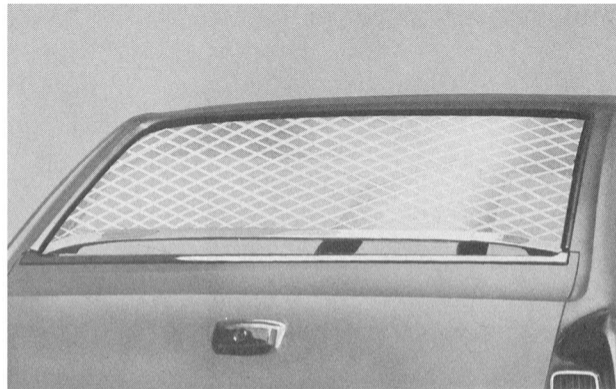

Station Wagon screen (Back window)

Fine reinforced mesh permits driving with window open, bug free. Held in place by raising window part way.

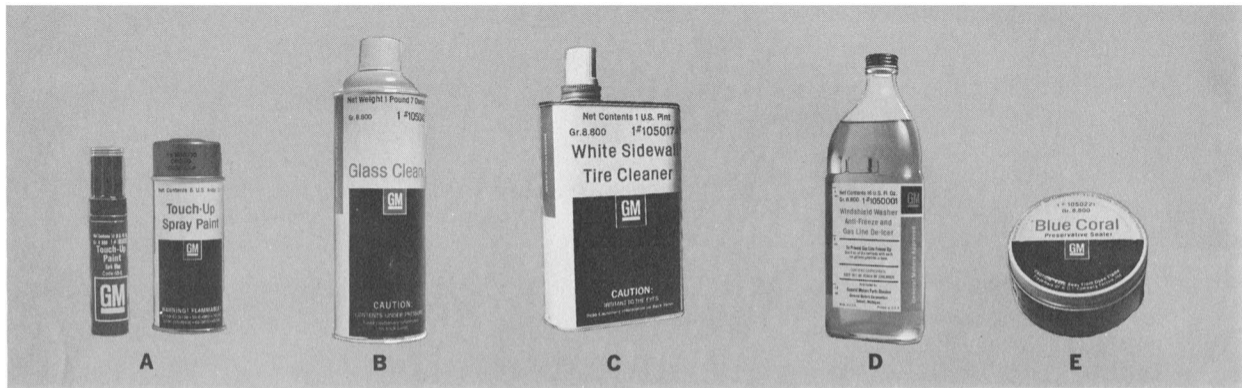

- A Touch up paint**—Brush tube or atomizer. Tube has handy brush in cap. Atomizer sprays on. Comes in all colors to match your car exterior.
- B Glass cleaner**—1 lb., 7 oz. giant-size window cleaner. Cuts grime, oily film. Spray on—wipe off.
- C Whitewall cleaner**—Not only removes normal dirt but also road tar, stains, etc.
- D Windshield washer solvent**—Works in freezing weather. Removes bugs, road grime, etc.
- E Blue Coral polish**—Unique combination of polishing and preservative ingredients.

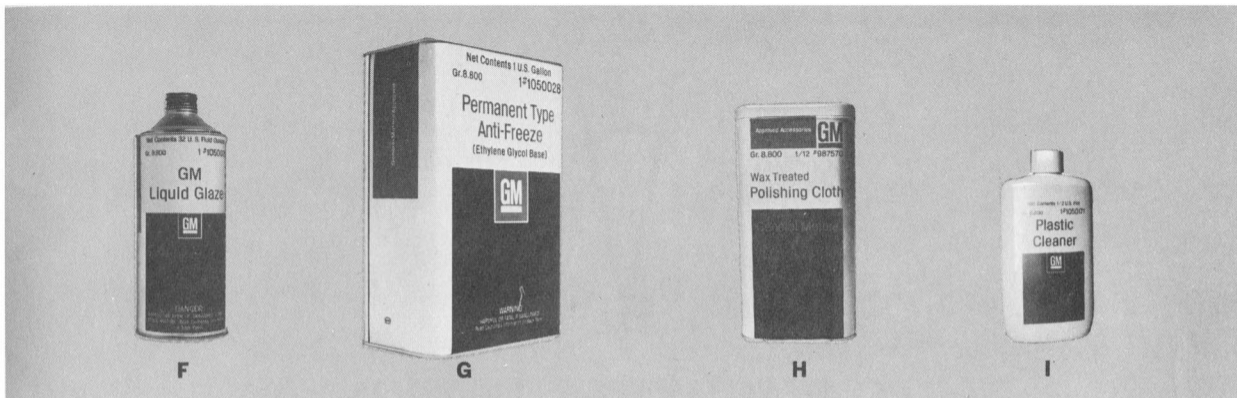

- F** **Liquid glaze polish**—Provides clear, hard and waterproof surface protector for acrylic lacquers.
- G** **GM anti-freeze**—Year-'round protection for your engine.
- H** **GM polishing cloth**—Large-size, wax-impregnated cloth. Can be used on cars or furniture.
- I** **Plastic cleaner**—Cleans convertible back windows and plastic surfaces.

Also, Porcelainize treatment available at your dealer.



PONTIAC MOTOR DIVISION

General Motors Corporation

Pontiac Motor Division of General Motors Corporation reserves the right to make changes at any time, without notice, in prices, colors, materials, equipment, specifications and models, and also to discontinue models.