



Accessories by Pontiac-1966

# 1966 Pontiac Accessories Index

TEMPEST/TEMPEST CUSTOM/LE MANS/GTO/CATALINA/VENTURA/2+2/STAR CHIEF EXECUTIVE/BONNEVILLE/BROUGHAM/GRAND PRIX

Even though you have your choice of forty different Pontiac models for 1966, you may wish to tailor the car of your choice to meet your specific needs. On the following pages, you'll find the accessories and options that will help make your Pontiac even more enjoyable than you ever imagined.

GROUPS. These are a combination of some of the more popular Pontiac accessories. Each group is factory-installed, to save you time and installation cost.

(D) following the description of the accessory, means the accessory can be installed by the dealer. (F) indicates that the item is a factory installed accessory. (F,D) shows that the item can be installed at the factory or by your dealer.

Note: "P" column lists pages for Pontiac Catalina, Ventura, 2+2, Star Chief Executive, Bonneville, Brougham and Grand Prix. "T" column lists pages for Pontiac Tempest, Tempest Custom, Le Mans and GTO.

	P	T
Air Conditioning	4	26
Antenna, Electric Power	8	31
Brakes, Power	7	28
Carpet, Custom		45
Carrier, Chrome Luggage	20	42
Carrier, Roof or Deck Lid Ski	15	
Carrier Adapter, Removable Ski	20	42
Clock, Electric	14	
Clock, Rally		38
Cluster, Custom Gauge	19	
Cluster, Rally		38
Compass	18	41
Consoles	23	45
Convertible Top, Power-operated		29
Cover, Instrument Panel	16	
Cover, Luggage Carrier	20	42
Cover, Spare Tire and Wheel	15	37
Cover, Tonneau	18	37
Cushion, Custom Front Seat	18	
Cushion Topper	18	41
Defogger, Rear Window	5	26
Deflector, Station Wagon Rear Window	21	43
Differential, Safe-T-Track	16	38
Dispenser, Chrome Tissue	14	36
Exhausts, Dual	17	39
Extension, Dual Exhaust		38
Electro-Cruise System	7	
Fender Skirts	18	
Flasher, Traffic Hazard	11	32
Gearshift Knob		45
Glass, Soft-Ray	5	27
Guard, Door Edge	18	41
Headrest	23	45
Heater, Engine Block Water	16	36
Horns, Dual		41
Ignition System, Full Transistor	17	39
Lamp, Luggage Compartment		32
Lamp, Side Roof Rail Courtesy and Reading	11	32
Lamp, Parking Brake Warning		33
Lamp, Glove Compartment		33
Lamp, Spot	11	
Lamp, Ashtray and Lighter		33
Lamp, Underhood		33
Lamp, Underhood Utility	10	
Lamp, Instrument Panel and Courtesy		33
Litter Basket	14	36
Lock, Gas Cap	21	43

	P	T
Lock System, Power Door	15	
Lock, Rear Door Safety	15	29
Lock, Spare Tire	15	37
Lock, Station Wagon Luggage Compartment	20	
Mats, Floor	18	40
Mirror, Remote-control Outside	13	34
Mirror, Non-glare Inside	13	34
Mirror, Visor Vanity	13	34
Pad, Utility	20	42
Radios	9	30
Release, Rear Deck Lid	6	28
Safeguard Speedometer and Fuel Warning Lamp	11	32
Seats, Power-operated	7	28
Seat, Reclining Bench, right side	22	
Seat, Reclining Bucket, right side	23	45
Seat Belts with Retractors, Custom Front and Rear	12	35
Screens, Rear Door Window	21	43
Screen, Tailgate Window	21	43
Shock Absorbers, Super-Lift	17	39
Speaker, Rear	8	31
Speaker, Rear for Station Wagons	20	
Speaker, Verbra-Phonic Rear System	8	31
Steering Wheel, Custom Sports	19	38
Steering Wheel, Deluxe	19	40
Steering, Power	6	28
Steering Wheel, Tilt	19	40
Tachometer	14	
Ventshades	5	27
Voltage Regulator, Full Transistor	17	39
Wheel Discs	22	44
Wheels, Rally		44
Wheel Hub and Drums, Aluminum	22	
Window Lifts, Power-operated	6	29
Window, Power-operated Vent	6	
Window, Power-operated Tailgate	21	43

## GROUPS

Basic Group	2	24
Lamp Group		24
Protection Group	3	25
Mirror Group	3	25
Decor Group	2	24

## *Basic Group (code 061)*

Push-button Radio with Manual Antenna.  
Custom Foam Front Cushion for all cars except  
2+2 and Grand Prix.  
Electric Clock for Catalina, Ventura and 2+2  
models.

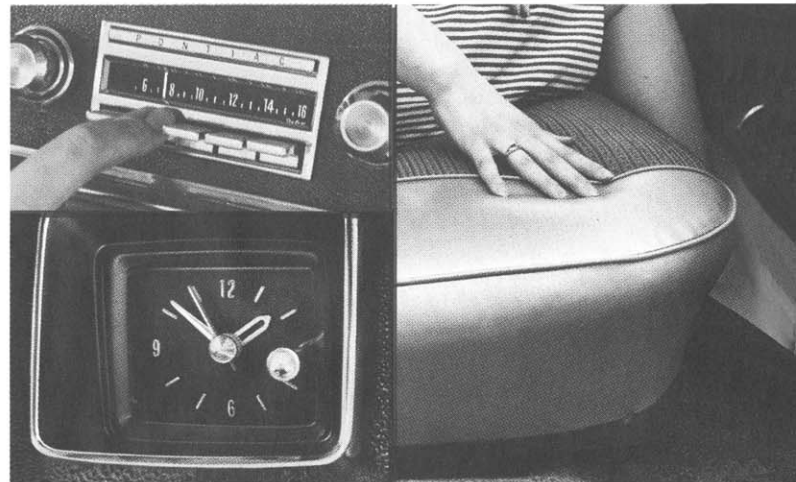

## *Decor Group (code 064)*

*Available for Catalina series only.*

Deluxe Wheel Discs.  
Deluxe Steering Wheel.  
Decor Mouldings.

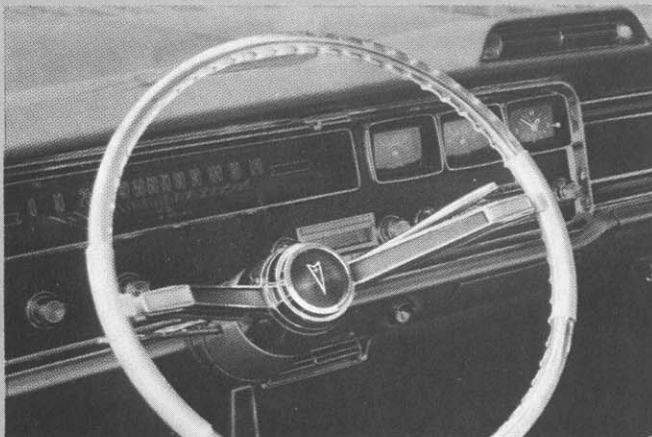

Deluxe Steering Wheel (Code 462) (F,D)

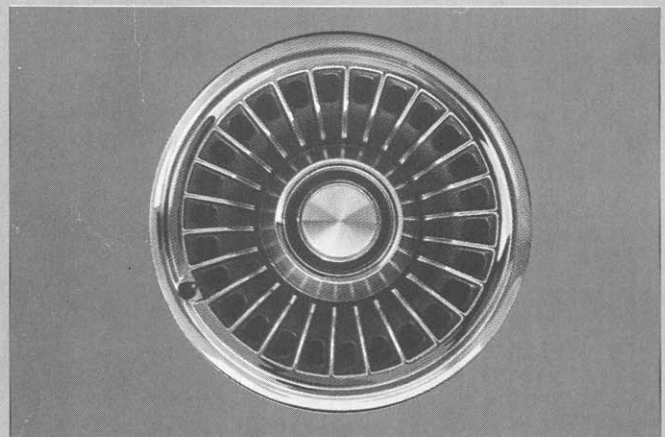

Deluxe Wheel Discs (Code 462) (F,D)

## Protection Group (code 062)

Spare Tire Cover for Catalina and 2+2 models except Station Wagons.  
 Rear Window Defogger for all cars except Station Wagons and Convertibles.  
 Instrument Panel Cover for Catalina, Ventura, 2+2 and Star Chief Executive models. (Included when equipped with air conditioning.)  
 Door Edge Guards.  
 Custom Seat Belts, Front and Rear.  
 Floor Mats, Front and Rear.

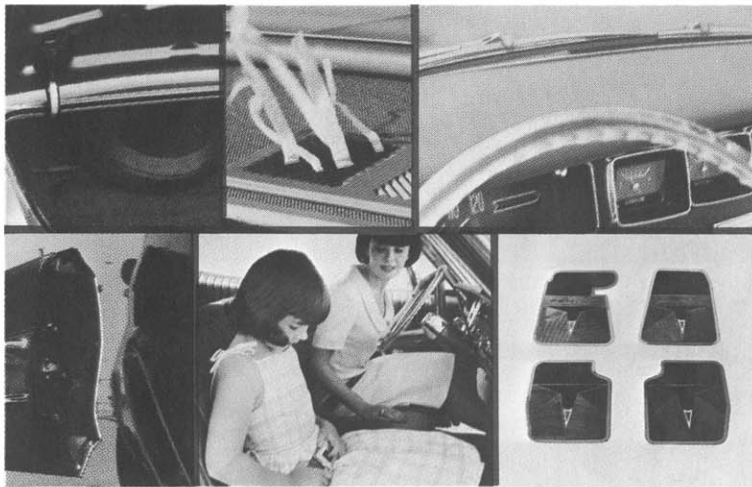

## Mirror Group (code 071)

Visor Vanity Mirror.  
 Non-glare Inside Rear View Mirror.  
 Outside Remote-control Mirror.

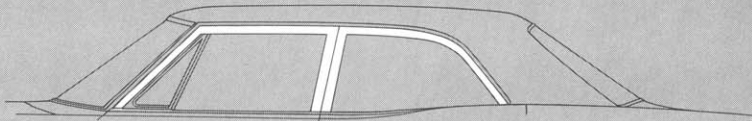
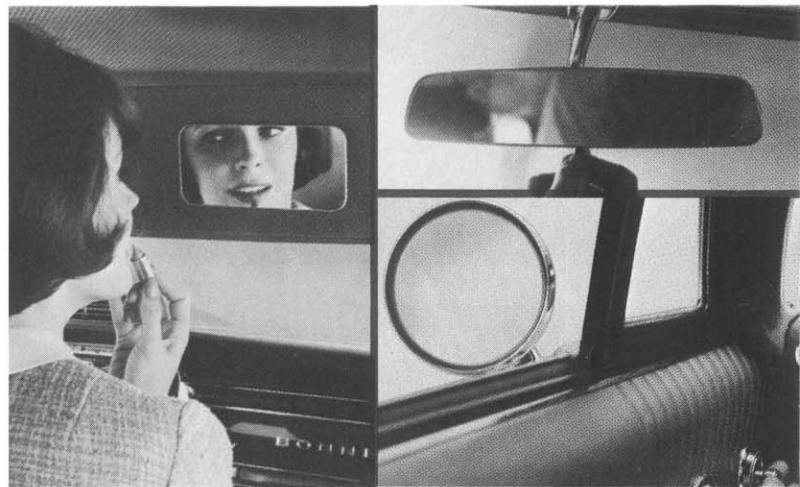

**Catalina 4-Door Sedan Custom Exterior Trim (Code 464)**

Features bright metal front and rear door window frame mouldings as well as rear-belt finish moulding. (F)

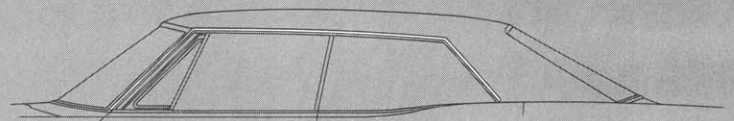

**Catalina 4-Door Hardtop Custom Exterior Trim (Code 464)**

Features a bright metal roof-drip scalp moulding along edge of roof. (F)

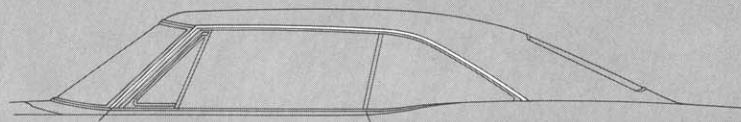

**Catalina Hardtop Coupe Custom Exterior Trim (Code 464)**

Features a bright metal roof-drip scalp moulding along edge of roof. (F)

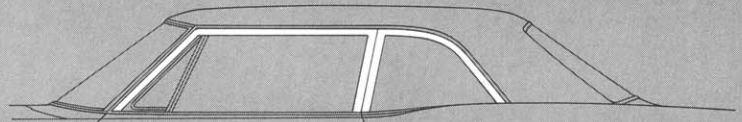

**Catalina 2-Door Sedan Custom Exterior Trim (Code 464)**

Features bright metal door and rear-quarter window frame mouldings as well as rear-belt finish moulding. (F)

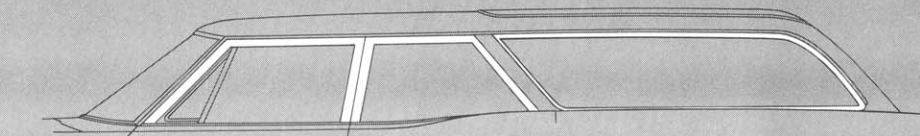

**Catalina 2- and 3-Seat Station Wagon Custom Exterior Trim (Code 464)**

Features bright metal door, window frame and rear-quarter window frame moulding. (F)

CATALINA • VENTURA • 2+2  
STAR CHIEF EXECUTIVE  
BONNEVILLE • BROUGHAM • GRAND PRIX

---



**A. Custom Air Conditioner (Code 582)**

Combined with Circ-L-Aire heater gives full range of comfort control. Heats or cools air, controls humidity, limits window fogging, removes pollen from air. Permits riding in cool or warm, clean, noise-free comfort. (F,D)

**B. Automatic Temperature Control Air Conditioning (Code 581 with 582)**

Set the temperature comfort level you desire. Automatic control will keep it at that level until you change it to another level setting. (F)

**C. Rear Window Defogger (Code 374)**

Blower under rear package shelf directs air through grille to rear window for clearer view. (Not available on Station Wagons or Convertibles.) (F,D)

**D. Soft-Ray Glass (Code 531)**

All windows are fully tinted for reduced glare with upper windshield area shaded for added glare reduction. Reduced eye strain permits more comfortable driving. Recommended with air conditioning. Also available on windshield only. (Code 532) (F)

**E. Ventshades**

Fit snugly over top of side windows. Help to protect occupants from sun and rain when windows are slightly open. Not available for Convertibles or Hardtops. (D)

A. Custom Air Conditioner ▲

B. Automatic Temperature Control Air Conditioning ▼

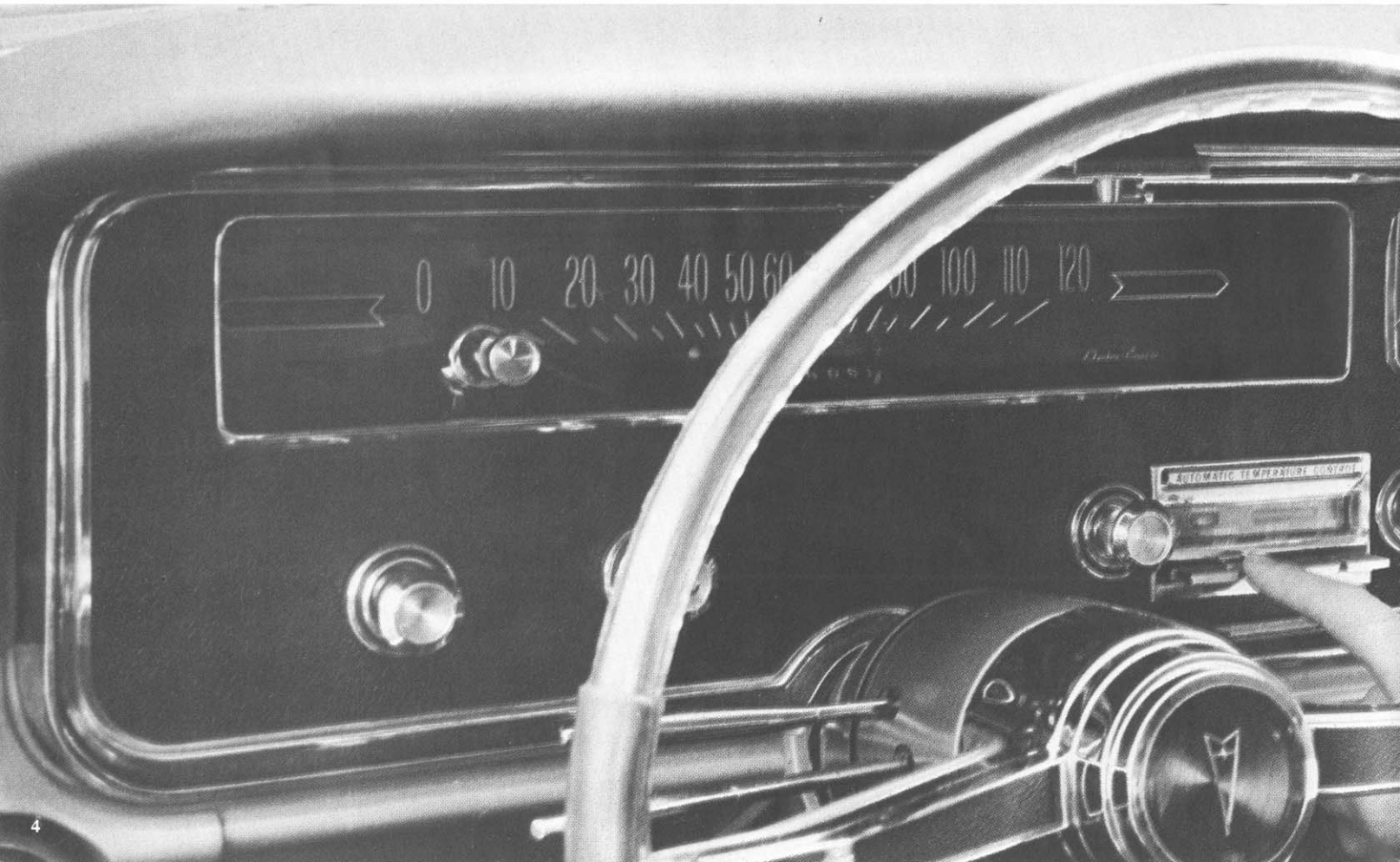



C. Rear Window Defogger ▲



D. Soft-Ray Glass ▲



E. Ventshades ▲





A. Power Steering ▲

B. Rear Deck Lid Release ▼

C. Power Window Lifts ▼

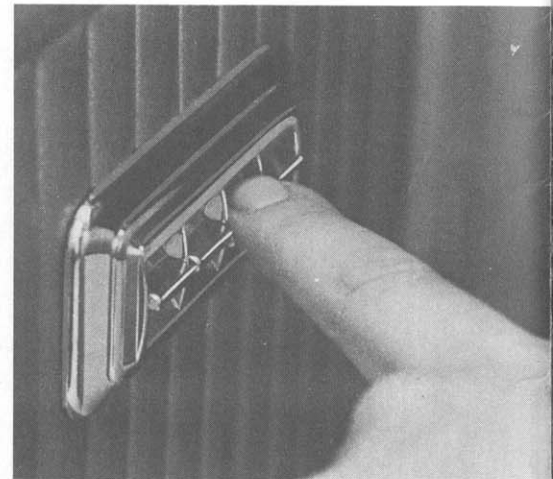

D. Power-operated Vent Windows ▼

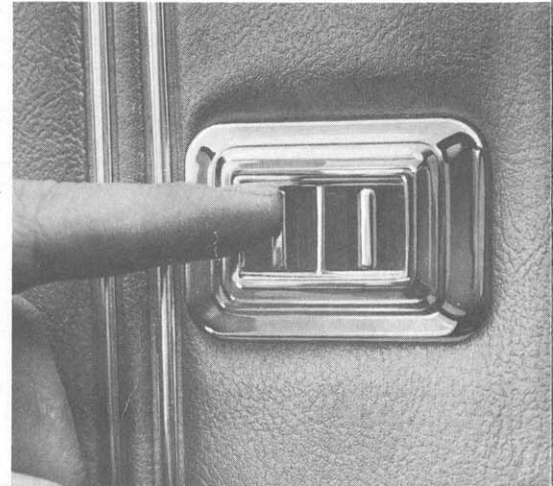



E. Power 6-Way Bench Seat ▲

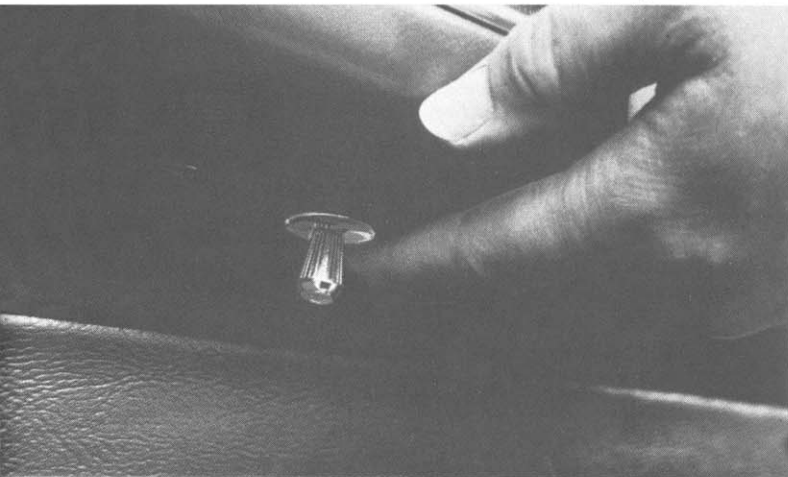

F. Power Bucket Seat ▲

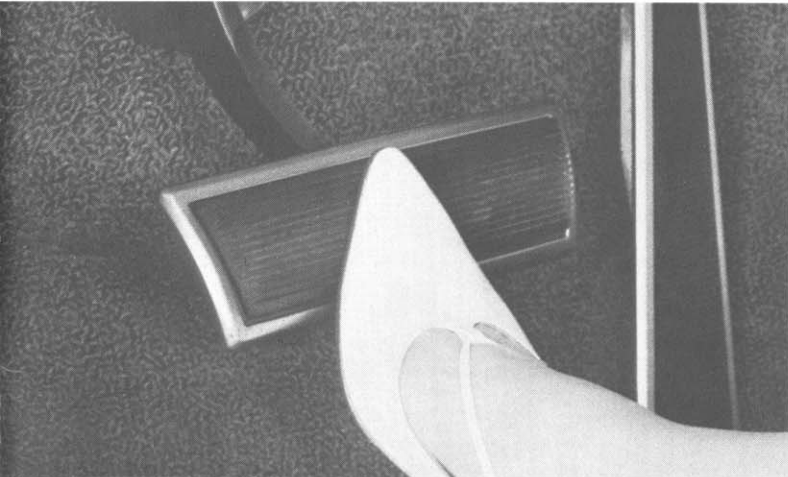

G. Power Brakes ▲

H. Electro-Cruise System ▼

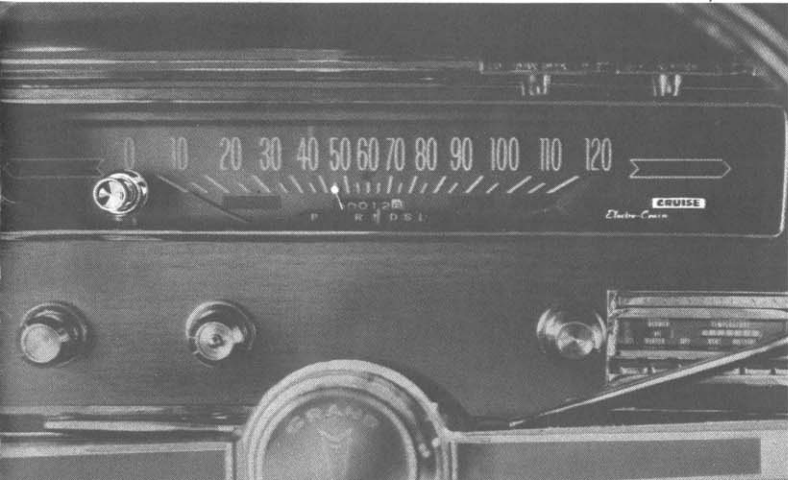

CATALINA • VENTURA • 2 + 2  
STAR CHIEF EXECUTIVE  
BONNEVILLE • BROUGHAM • GRAND PRIX

**A. Power Steering (Code 501)**

Drive, turn, park with ease. One to two pounds effort sufficient for steering, yet retains feel of control. (F,D)

**B. Rear Deck Lid Release (Code 422)**

Provides the convenience of opening trunk from the driver's seat. Push-button control located inside glove box. Trunk also may be opened by key. All models except Station Wagon. (F,D)

**C. Power Window Lifts (Code 551)**

Automatically operate all vertical side windows from a single control panel at the driver's side. Individual control button at each window. (F)

**D. Power-operated Vent Windows (Code 552)**

Automatically operate vent windows. Available only with Power Window Lifts and only on Bonneville and Grand Prix. (F)

**E. Power 6-Way Bench Seat (Code 561)**

Unlimited seat positions for greater comfort and safer driving. Makes it easier to change driver's position on trips, lessening fatigue. Available with full-width seat only. (F)

**F. Power Bucket Seat (Code 564)**

Moves seat forward and backward; raises and lowers seat to unlimited positions for driving comfort. (F)

**G. Power Brakes (Code 502)**

Positive braking with light touch of toe. Includes bright metal trim plate on brake pedal when factory installed. (F,D)

**H. Electro-Cruise System (Code 442)**

Control located on instrument panel automatically maintains pre-selected car speed. Lamp indicates "Cruise" when in operation. Releases to manual control upon slightest brake pedal pressure. Great for turnpikes. Also includes low-fuel level warning lamp on fuel gauge. Available only with Turbo Hydra-Matic. Not available with Custom Gauge Cluster or Safeguard Speedometer. (F,D)



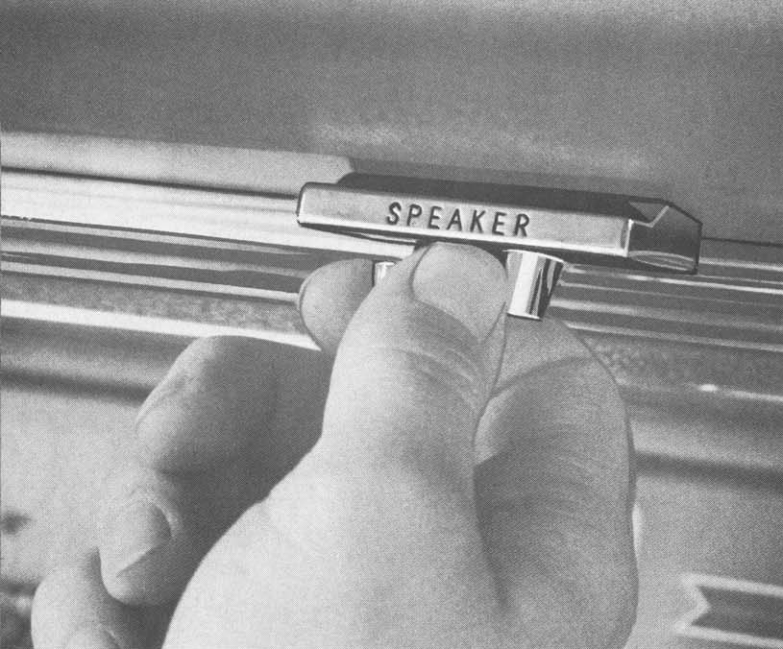

A. Rear Speaker ▲

B. Verbra-Phonic Rear Speaker System ▼



C. Electric Power Antenna ▼

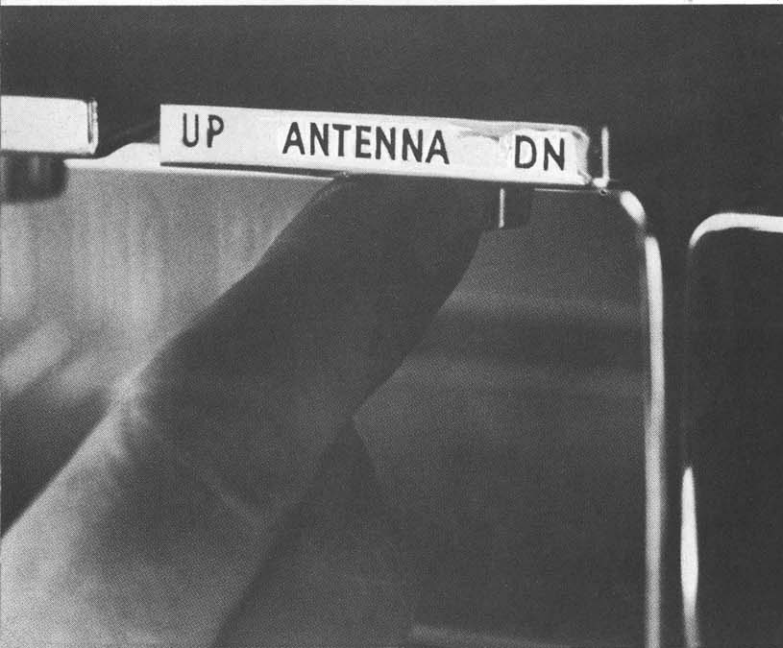

CATALINA • VENTURA • 2+2  
STAR CHIEF EXECUTIVE  
BONNEVILLE • BROUGHAM • GRAND PRIX

---

**A. Rear Speaker (Code 351)**

Brilliant tone and depth control. 3-step switch lets you play front, rear or both speakers. (F,D)

**B. Verbra-Phonic Rear Speaker System (Code 352)**

Brilliant tone simulates acoustics in an auditorium when both speakers are playing. 3-step switch lets you play through front, rear or both speakers. All models except Station Wagon. (F,D)

**C. Electric Power Antenna**

Available with all radios. Raised or lowered by switch on instrument panel. Mounted on right rear fender on all models. (F,D)

**D. Push-button AM-FM Radio and Manual Antenna (Code 344)**

Offers dual listening enjoyment on either FM or AM frequencies. Completely transistorized. Push-buttons can be set to either AM or FM or combination of both. Unusually fine quality and fidelity. (F,D)

**E. Push-button Radio and Manual Antenna (Code 342)**

Completely transistorized. Superior tone and fidelity. Wide dial provides space for precise tuning. Antenna has oval shaped cross section that offers minimum resistance to wind.

**F. Wonder-Bar Radio and Manual Antenna (Code 348)**

When traveling, you don't have to know location of stations. Amazing "signal-seeking" feature locates strongest station in area at finger touch. Five convenient push buttons may be set to stations you use most frequently in your own area. Completely transistorized.



D. Push-button AM-FM Radio ▲

E. Push-button Radio ▼

F. Wonder-Bar Radio ▼





A. Underhood Utility Lamp

CATALINA • VENTURA • 2+2  
STAR CHIEF EXECUTIVE  
BONNEVILLE • BROUGHAM • GRAND PRIX

---

**A. Underhood Utility Lamp (Code 421)**

Has about 17 feet of self-storing extension cord. Ideal for emergency repairs or tire changes after dark. Available on all models. (F,D)

**B. Traffic Hazard Flasher (Code 521)**

Flip the switch and parking and stop lamps will blink simultaneously. Excellent precaution for emergency off-highway stops. (F,D)

**C. Side Roof Rail Courtesy and Reading Lamps (Code 404)**

Mounted on interior side roof rails; one lamp on each side. Provides more light for map-reading, etc. Reading lamp has individual switch. Not available on Convertibles. (F)

**D. Safeguard Speedometer and Fuel Warning Lamp (Code 441)**

Control knob lets you select desired speed limit, and buzzer signals when car exceeds this speed. Not available with Electro-Cruise or Custom-Gauge Cluster. (F)

**E. Spot Lamp**

Easily controlled from inside of car. Completely chromed for long-wearing durability. Great for reading road signs, house numbers, etc., at night. Can be installed on left or right side. (D)



**B. Traffic Hazard Flasher ▲**



**C. Side Roof Rail Courtesy and Reading Lamps ▲**

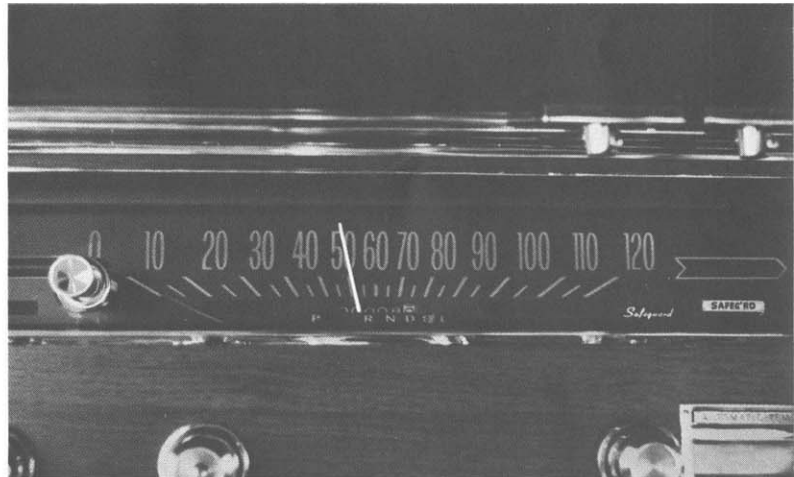

**D. Safeguard Speedometer and Fuel Warning Lamp ▲ E. Spot Lamp ▼**

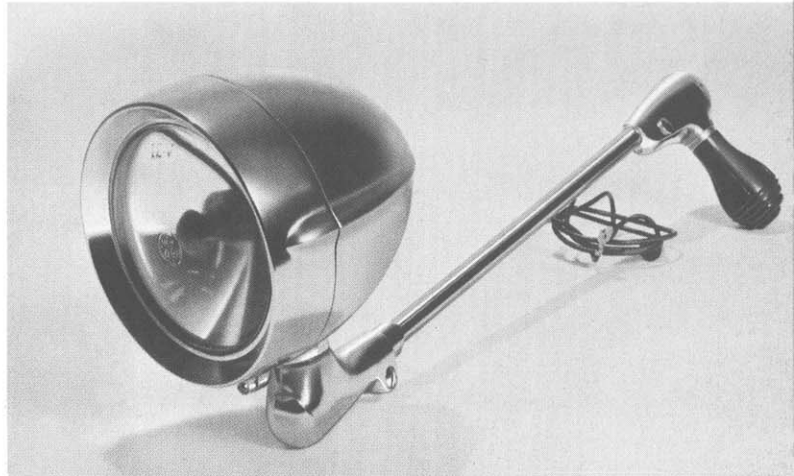



A. Custom Front and Rear Seat Belts with Retractors

CATALINA • VENTURA • 2+2  
STAR CHIEF EXECUTIVE  
BONNEVILLE • BROUGHAM • GRAND PRIX

---

**A. Custom Front and Rear Seat Belts with Retractors  
(Code 431)**

On 4-door models Custom Seat Belts with retractors in both front and rear. On 2-door models Custom Seat Belts with retractors on front seat; Custom Seat Belts less retractors on rear seat. On 3-seat Station Wagons Custom Seat Belts with retractors on front and second seat; seat belts less retractors on third seat. Push-button on buckle releases belt which then retracts into housing when not in use. Seat belt colors harmonize with interiors. (F)

**B. Remote-control Outside Mirror (Code 394)**

Mounts on left-hand door. Easily adjusted from inside car. Provides sharp, clear image. (F)

**C. Non-glare Inside Mirror (Code 392)**

Has special finger knob to permit easy adjustment to non-glare or nighttime driving position. (F,D)

**D. Visor Vanity Mirror (Code 391)**

Mounts on back of visor. Out of sight when not in use. Ideal for checking make-up, combing hair, etc. (F,D)

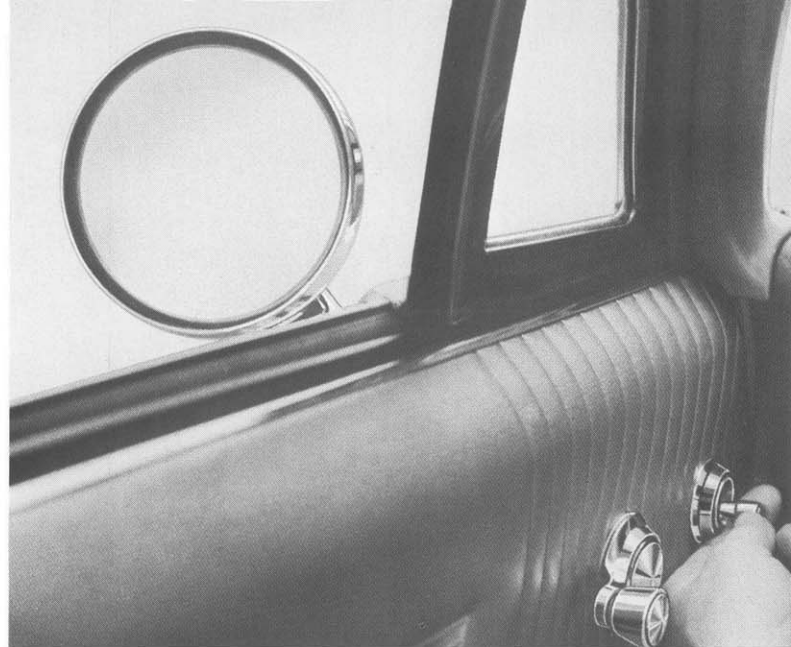

**B. Remote-control Outside Mirror ▲**

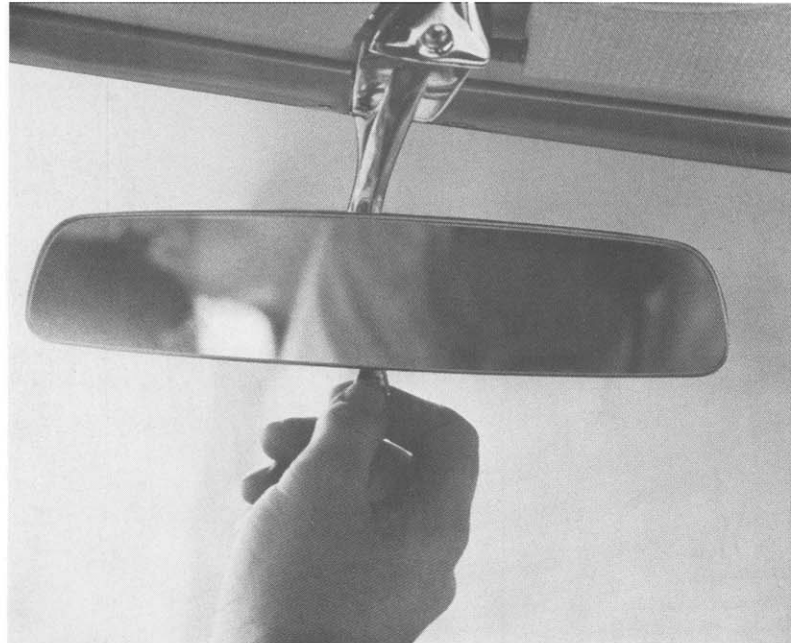

**C. Non-Glare Inside Mirror ▲**

**D. Visor Vanity Mirror ▼**



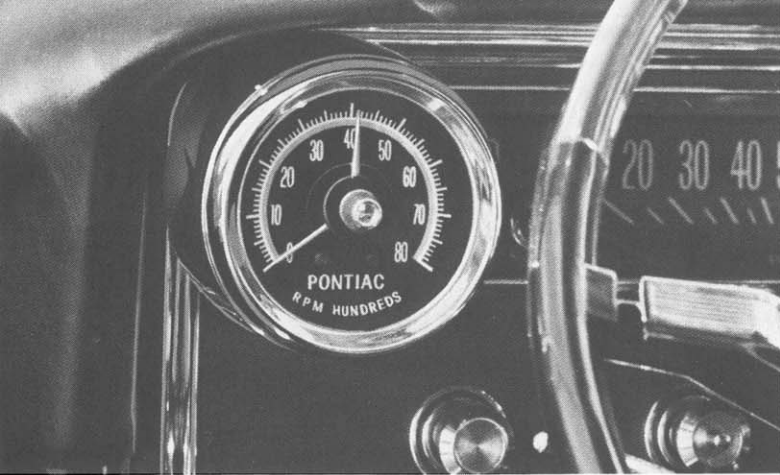

A. Tachometer ▲ B. Electric Clock ▼

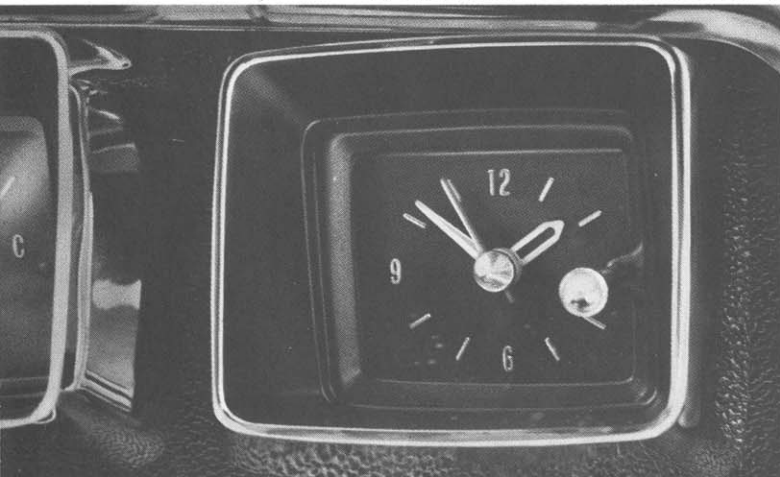

C. Chrome Tissue Dispenser ▼

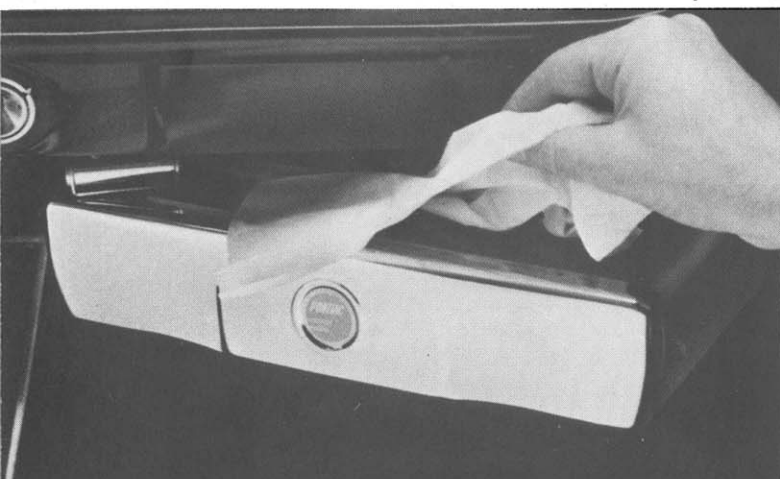

D. Litter Basket ▼

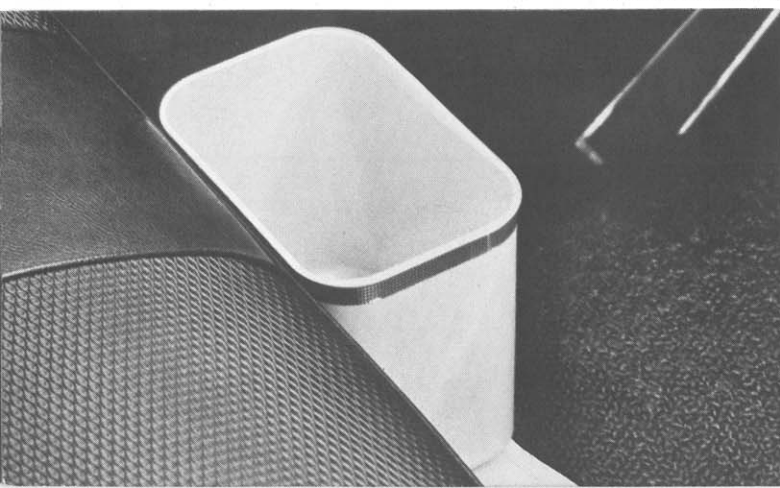

CATALINA • VENTURA • 2+2  
STAR CHIEF EXECUTIVE  
BONNEVILLE • BROUGHAM • GRAND PRIX

**A. Tachometer (Code 511)**

Shows engine RPM's on 250° dial. Enables you to maintain optimum driving performance and efficiency. (F,D)

**B. Electric Clock (Code 444)**

Features sweep second hand and built-in automatic self-regulator. Illuminated dial for easy night reading. (Standard on Star Chief Executive, Bonneville and Grand Prix. Optional on Catalina, Ventura and 2+2.) (F,D)

**C. Chrome Tissue Dispenser**

Holds regular-size tissue box. Swings out for use, swings back and locks in place when not in use. Not available on cars equipped with Air Conditioning. (D)

**D. Litter Basket**

Available in red, blue, black or beige to harmonize with car interior. Clings to transmission tunnel, weighted to prevent tipping. Easily removed for emptying. (D)

**E. Spare Tire Lock**

Prevents theft of spare tire and wheel in trunk. (D)

**F. Spare Tire and Wheel Cover (Code 372)**

Protects luggage from becoming marred. Slips on, off easily. Dresses up luggage compartment (all models except Station Wagons). Standard on Star Chief Executive, Bonneville and Grand Prix. Included with Ventura. (F,D)

**G. Rear Door Safety Lock (4-Door Models Only)**

Prevents children from opening rear door. When lock button is pushed down, rear doors can't be opened without inserting key into lock button. (D)

**H. Roof or Deck Lid Ski Carrier**

Can be installed or removed in minutes. Available all models. Carries up to six pairs of skis and has a key lock for protection against ski theft. (D)

**I. Power Door Lock System (Code 541)**

Master control lever located on door panel on driver's side, locks or unlocks all doors simultaneously. In lock position, rear doors are free-wheel. Pulling up on inside front door handles unlocks door. A fine security accessory. (F)

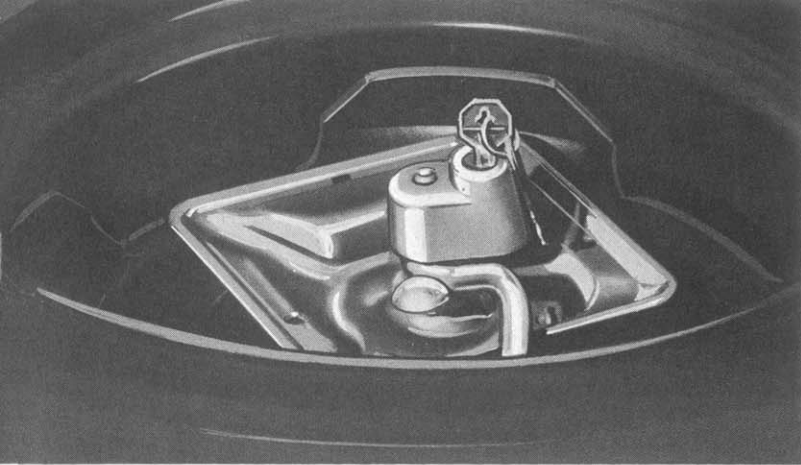

E. Spare Tire Lock ▲

F. Spare Tire and Wheel Cover ▼

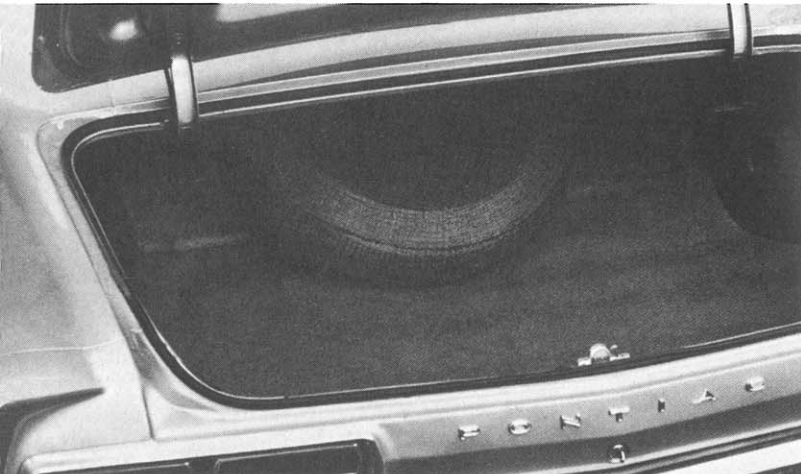

G. Rear Door Safety Lock ▼

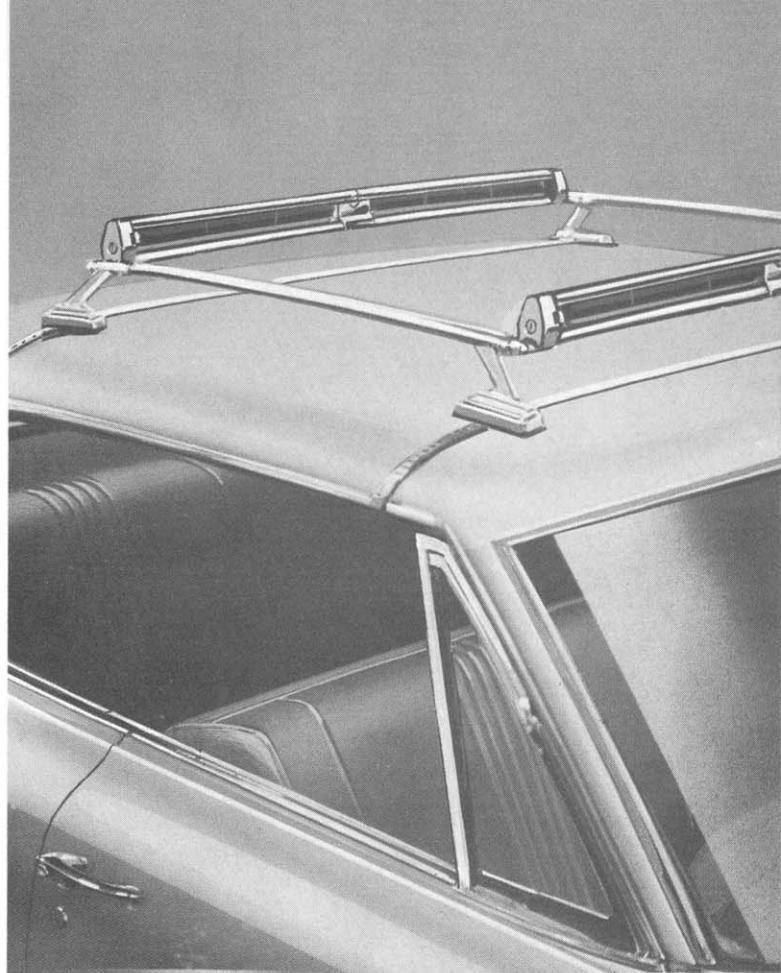

H. Roof or Deck Lid Ski Carrier ▲

I. Power Door Lock Systems ▼

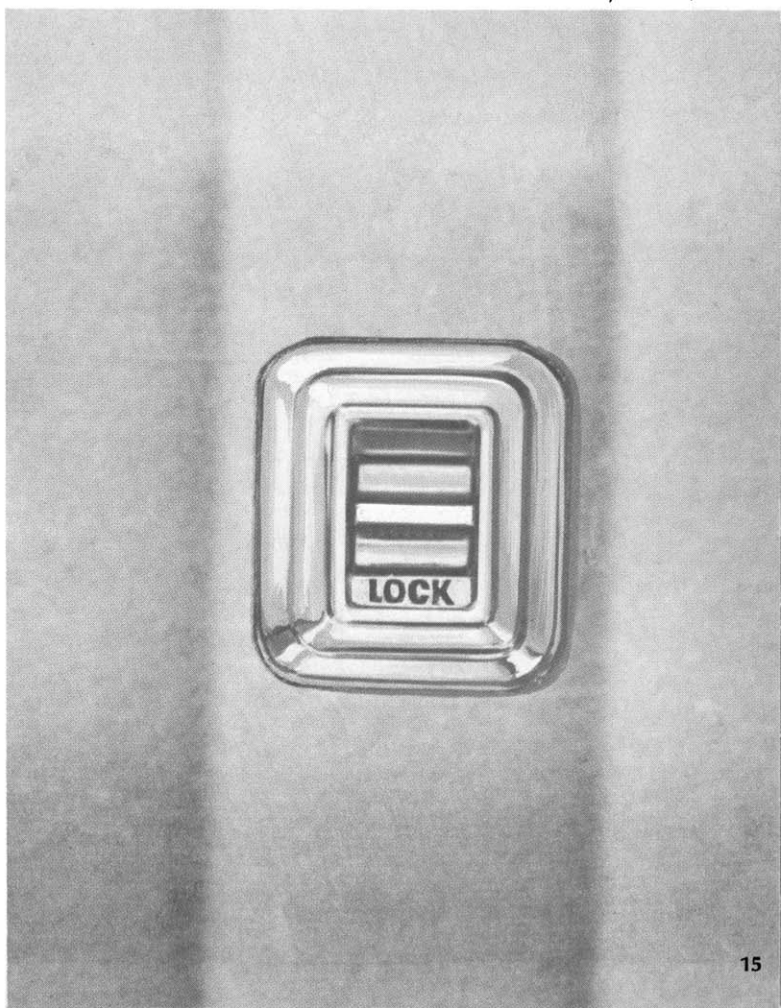
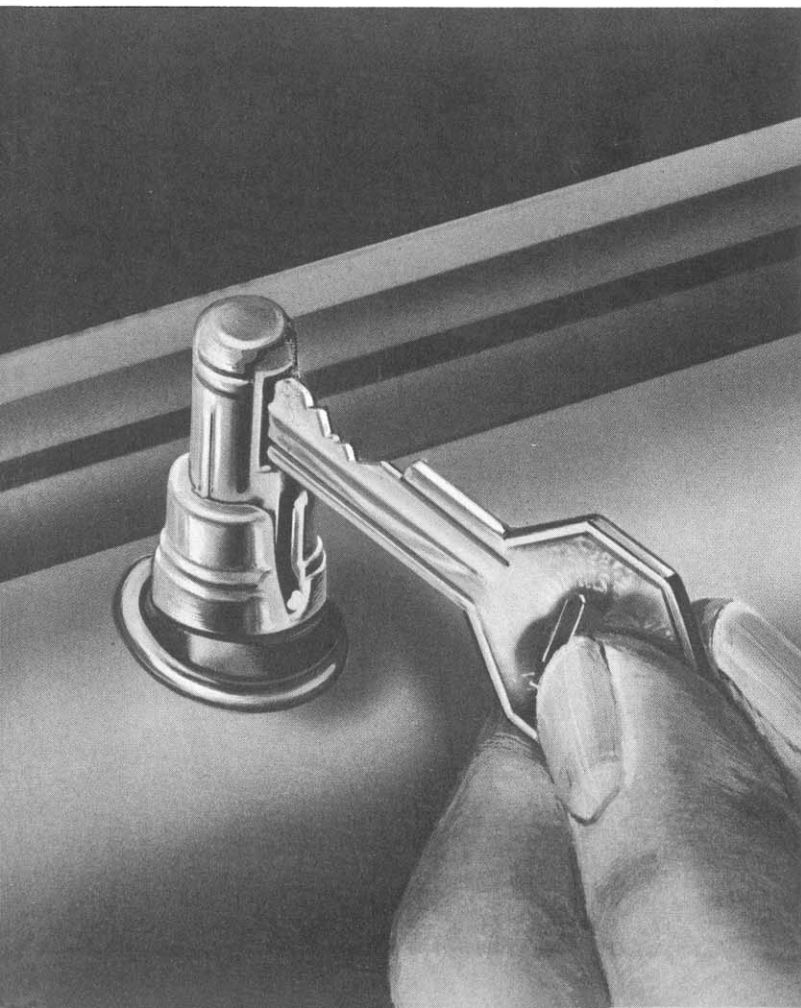



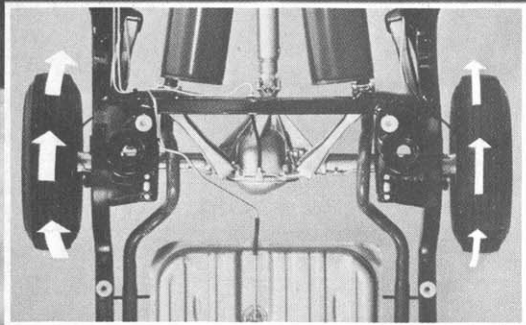

◀ A. Safe-T-Track Differential

B. Instrument Panel Cover ▼

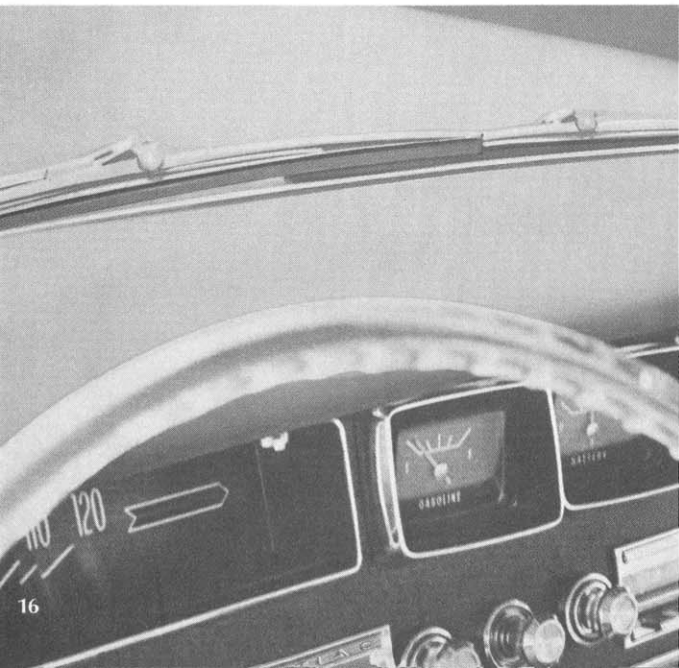

C. Engine Block Water Heater ▼



CATALINA • VENTURA • 2+2  
STAR CHIEF EXECUTIVE  
BONNEVILLE • BROUGHAM • GRAND PRIX

---



D. Dual Exhausts ▲

E. Superlift Shock Absorbers ▼

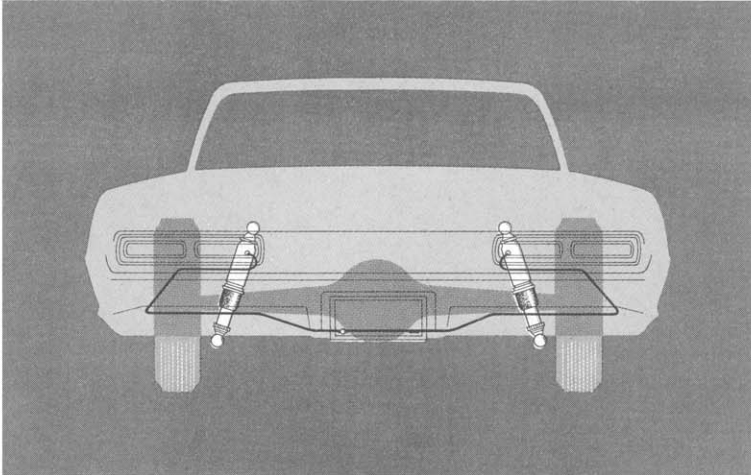

F. Full Transistor Ignition System ▼



G. Full Transistor Voltage Regulator ▼

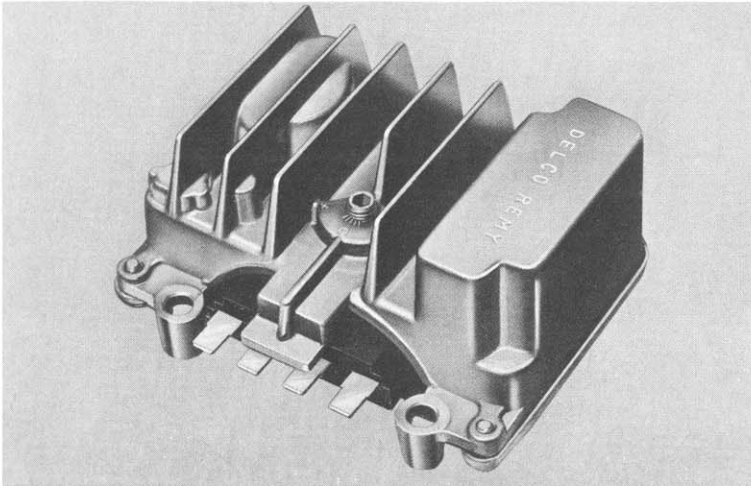

**A. Safe-T-Track Differential (Code 731)**

Power is directed from one driving wheel to the other, always the one with the best grip on the road surface. Controlled ride through rutted roads on sand or gravel, over bumps or chuck holes, through heavy snow, on wet or icy roads. Minimizes the hazard of getting stuck. (F)

**B. Instrument Panel Cover (Code 381)**

Resilient, smartly designed and finished in beautiful, durable vinyl. Harmonizes with interior colors. (Standard on Bonneville, Grand Prix and all models with Air Conditioning.) (F,D)

**C. Engine Block Water Heater**

Electric pre-heater for engine coolant provides fast, effortless engine starts, quick heater action during severe cold. Single unit raises engine coolant overnight from 0°F. to 50°F., dual unit to about 90°F. Operates from standard house electrical outlet. (D)

**D. Dual Exhausts (Code 481)**

Cuts down back pressure in exhaust system, adds to engine efficiency. Standard on Grand Prix, 2+2 and models with 421 HO engine option; optional on all other engines. (F)

**E. Superlift Shock Absorbers (Code 634)**

Help maintain level ride when trunk or trailer-tongue loads are extra heavy. Adjustable air spring is built into rear shock absorber. Equipped with tire-type air-filler valve for simple air fill at filling stations. (F,D)

**F. Full Transistor Ignition System (Code 671)**

The finest of ignition systems. Provides ignition without condenser or mechanical contacts. Combines increased high-speed output with greater ignition stability. Lengthens spark plug life, is rugged and water-proof. Available as option for premium fuel engines only. (F)

**G. Full Transistor Voltage Regulator (Code 664)**

Increases battery life, provides voltage regulation. No moving parts or breaker points. (F)

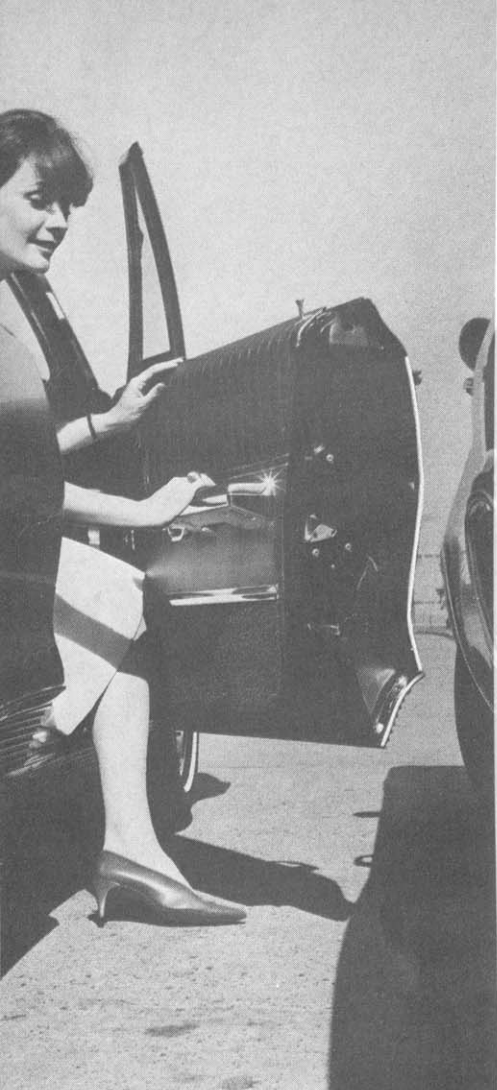

A. Door Edge Guards ▲

B. Fender Skirts ▼



D. Cushion Topper ▲

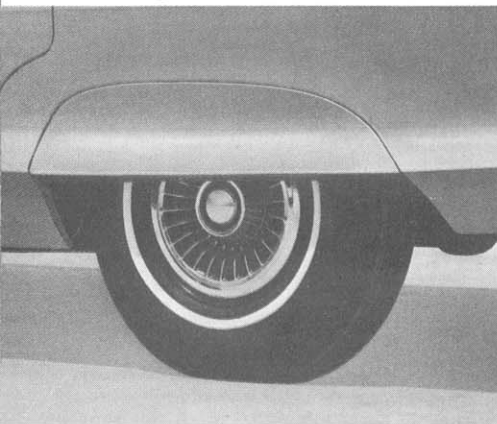

E. Floor Mats, Front and Rear ▼

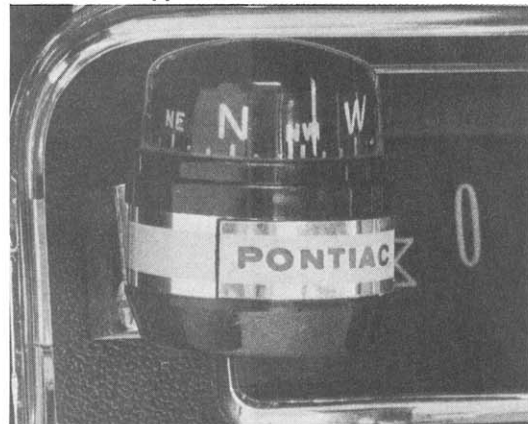

F. Car Compass ▲

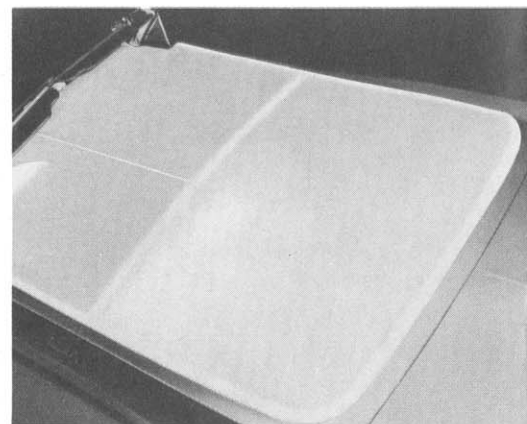

H. Tonneau Cover ▲

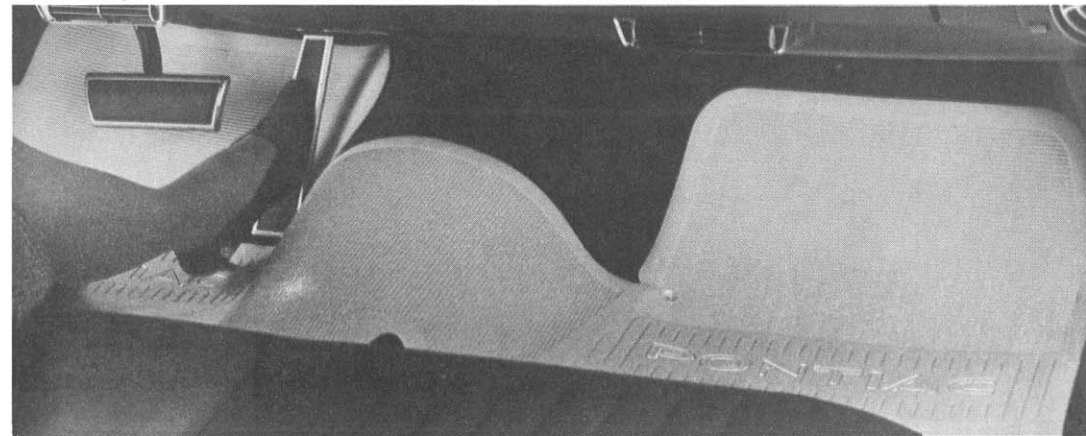
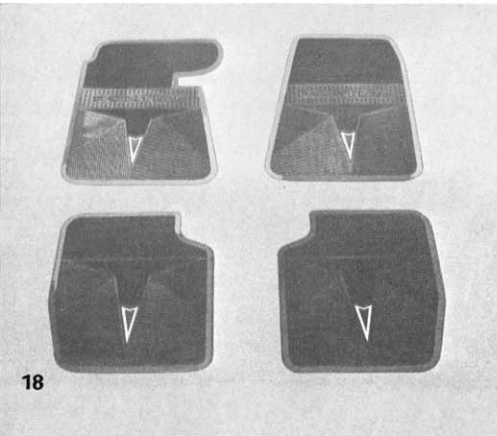

CATALINA • VENTURA • 2+2  
STAR CHIEF EXECUTIVE  
BONNEVILLE • BROUGHAM • GRAND PRIX

---

**A. Door Edge Guards (Code 382)**

Bright, stainless steel strips help prevent nicks and scratches on door edge. (F,D)

**B. Fender Skirts (Code 424)**

Optional on Catalina, 2+2 and Star Chief Executive, standard on Ventura, Bonneville and Grand Prix. Give smooth, continuous lines to body side sculpturing. Not available on Station Wagons or with standard hub caps. (F,D)

**C. Custom Foam Cushion—Front Seat (Code 371)**

For front bench seats only. Custom 2¼" foam pad reduces road shocks, provides more relaxing ride. Standard on Brougham. Not available on bucket or profile back bench seats which already have contoured foam padding. (F) (not illustrated)

**D. Cushion Topper**

Added front seat comfort. Sleek rayon with foam backing available in 6 colors to match interiors. (D)

**E. Floor Mats, Front (Code 631) Rear (Code 632)**

Keeps car looking new. Easily removed for washing. Available in 8 Pontiac colors to harmonize with the Pontiac interiors.

**F. Car Compass**

Dependable with special compensator for car use. Illuminated dial. (D)

**G. Full-width Floor Mat (Front Only)**

Long-lasting, easily removed for cleaning. Extends over center hump, protects whole floor. Available in 8 colors to complement interiors. (D)

**H. Tonneau Cover**

Protects Convertible interior from rain or hot sun when top is down. Sturdy vinyl snaps on or off in a jiffy. Can be left on when driver is alone. (D)

**I. Tilt Steering Wheel (Code 504)**

Adjusts to 7 different positions for individual physical requirements. Increases steering comfort, permits easier entry or exit. Enables better over-the-wheel vision for shorter people. Available with Power Steering only. Not available with 3-speed column shift. (F)

**J. Custom Sports Steering Wheel (Code 471)**

Handsome "just like wood" appearance. Has three equally spaced brushed stainless steel spokes. Horn button in center. (F)

**K. Deluxe Steering Wheel (Code 462)**

Horn activator bar recessed into each of the two wheel spokes. Standard on Ventura, 2+2, Star Chief Executive, Bonneville and Grand Prix; optional on Catalina (part of Decor Group). (F)

**L. Custom Gauge Cluster (Code 448)**

Gives more complete information with oil pressure and water temperature gauges. On Catalinas, Ventura and 2+2, electric clock is required. Not available with Electro-Cruise or Safeguard Speedometer. (F)



**I. Tilt Steering Wheel ▲**

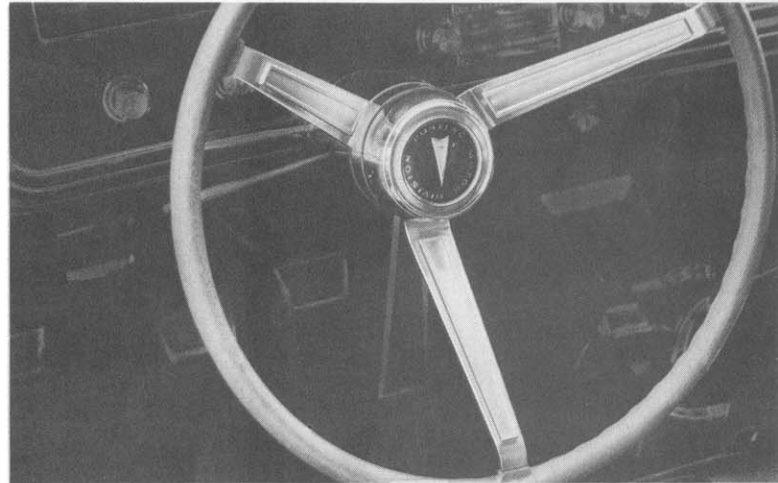

**J. Custom Sports Steering Wheel ▲**

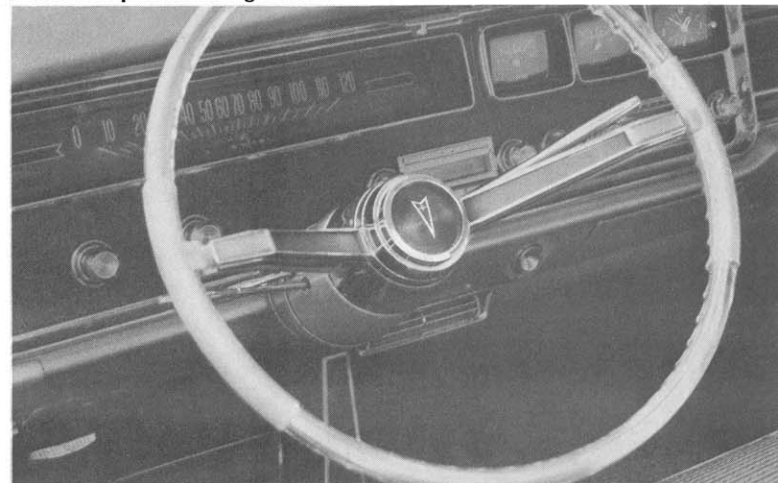

**K. Deluxe Steering Wheel ▲**

**L. Custom Gauge Cluster ▼**

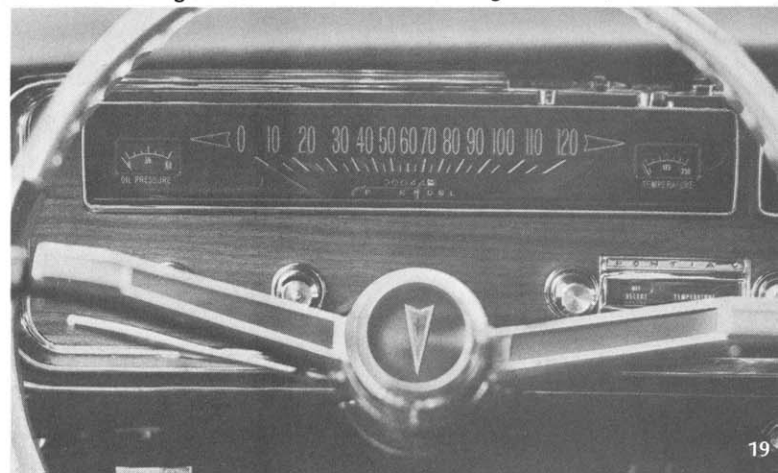

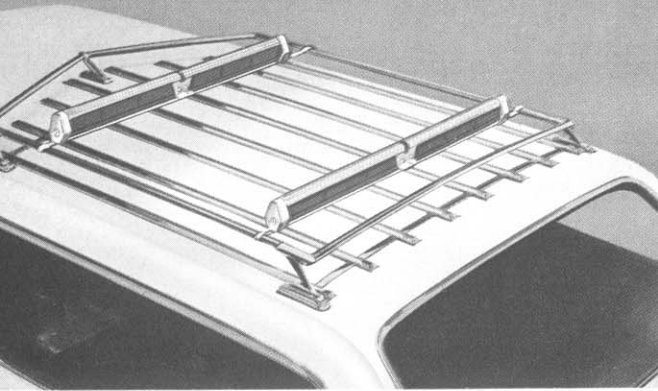

A. Removable Ski Carrier Adapter ▲

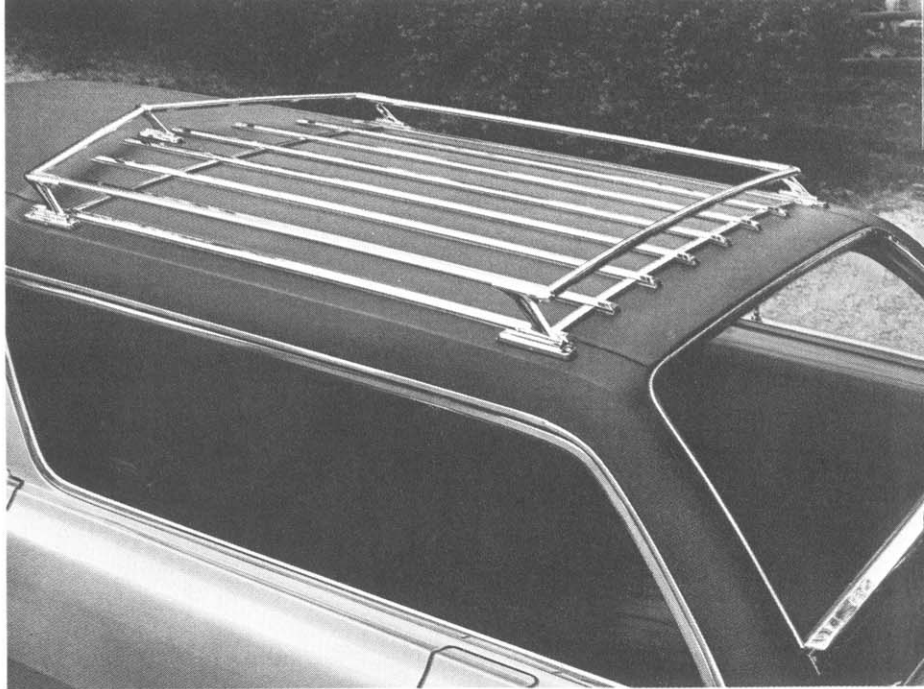

D. Chrome Luggage Carrier ▲

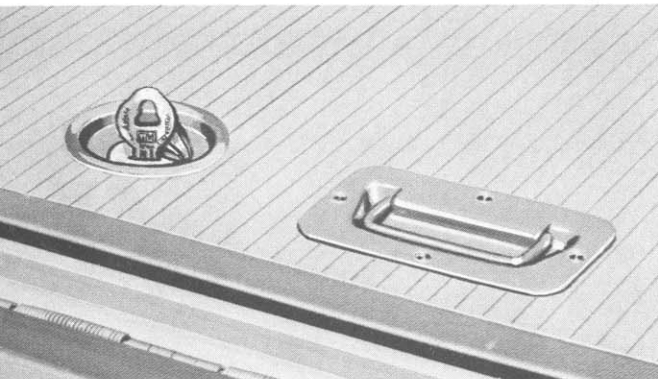

B. Station Wagon Luggage Compartment Lock ▲

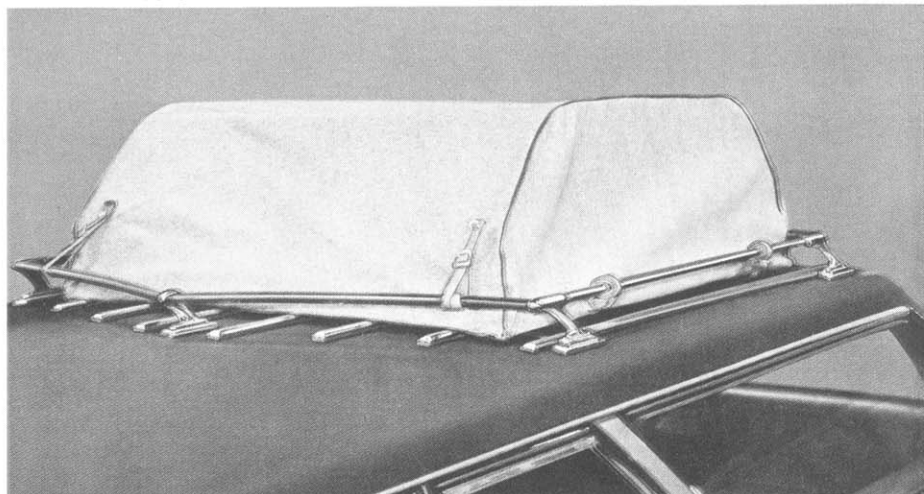

E. Luggage Carrier Cover ▲

F. Utility Pad ▼

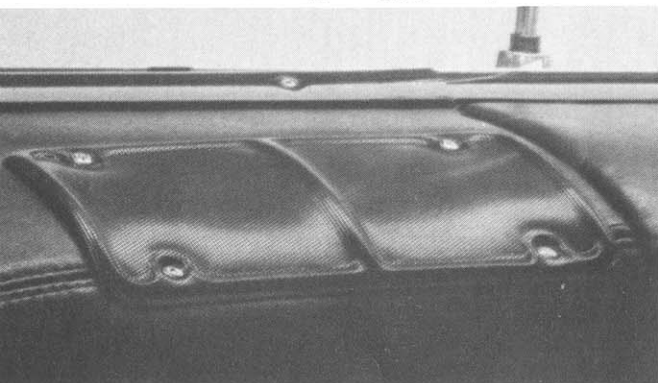

C. Separa-Phonic Rear Speaker for Station Wagon ▲



**CATALINA  
BONNEVILLE  
STATION WAGONS**

---

**A. Removable Ski Carrier Adapter**

Attaches to Station Wagon permanent luggage carrier in minutes. Carries up to six pairs of skis. Has key lock for protection against ski theft. (D)

**B. Station Wagon Luggage Compartment Lock**

Valuables in rear load compartment are extra safe when protected by this sturdy lock. 2-seat Station Wagon only. (D)

**C. Separa-Phonic Rear Speaker for Station Wagon (Code 351)**

Brilliant tone and depth control. 3-step switch lets you play front, rear or both speakers. (F,D)

**D. Chrome Luggage Carrier (Code 512)**

Handsome, sturdy. Carries plenty of luggage, allowing extra passenger space inside. Handy side rails provide tie-down. Permanently installed on Station Wagons. (F,D)

**E. Luggage Carrier Cover**

Water and dust resistant fabric protects luggage. Side opening can be locked. Cover folds flat when not in use. Removable types for either Station Wagon luggage rack or Sedans and Coupes. (D)

**F. Utility Pad**

Doubles as rear load area pad whenever needed. Constructed of durable, resilient coated fabric. Available in two-tone combinations of gray and aqua, mahogany and green or yellow and red. (D)

**G. Power Tailgate Window (Code 542)**

Conveniently located switch raises or lowers tailgate window with touch of finger. Makes it easier to open tailgate. Standard on 3-seat Station Wagons. (F)

**H. Station Wagon Rear Window Deflector (Code 378)**

Horizontal metal vane directs airstream down over rear window; helps keep it free of dust. Also promotes quieter ventilation of interior when cowl vents are open, side windows closed and rear window open. (F,D)

**I. Tailgate Window Screen**

Lets you keep the tailgate window open when camping. Made of fine reinforced mesh. Held in place by raising window part way. (D)

**J. Rear Door Window Screens**

Great for campers, children or pets. Attaches permanently to inner rear door window frame. Windows may be raised or lowered without removing screen. (D)

**K. Gas Cap Lock (Station Wagons Only)**

Prevents fuel theft. Separate key. (D)

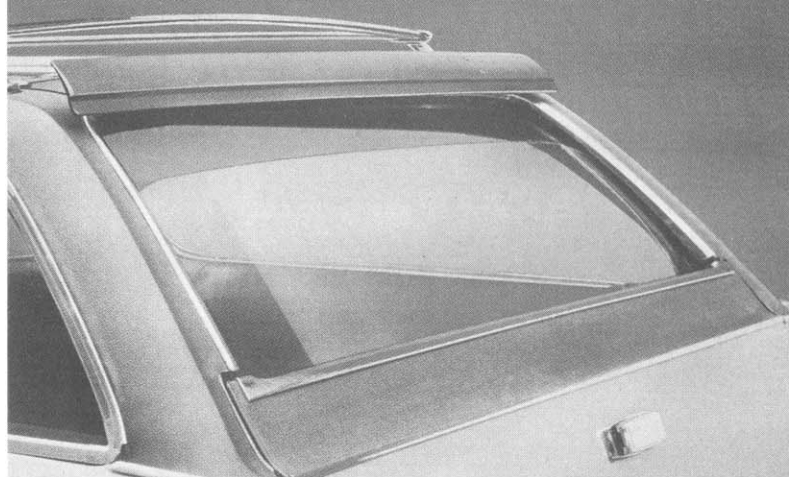

**G. Power Tailgate Window ▲ H. Station Wagon Rear Window Deflector ▲**

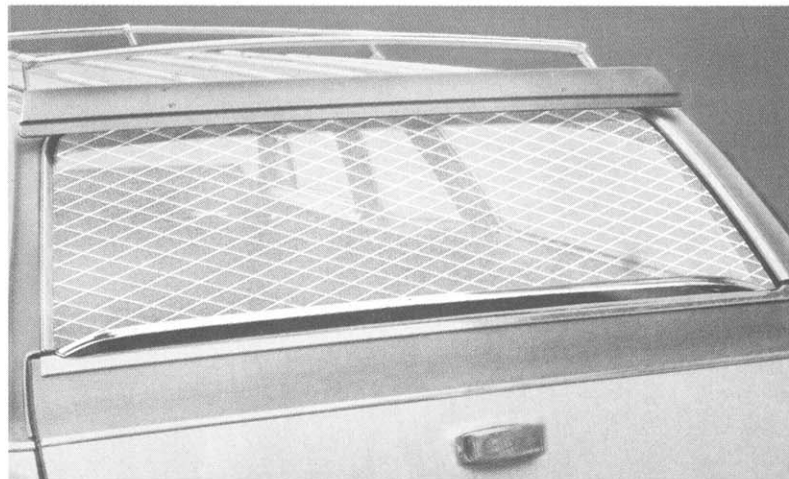

**I. Tailgate Window Screen ▲**

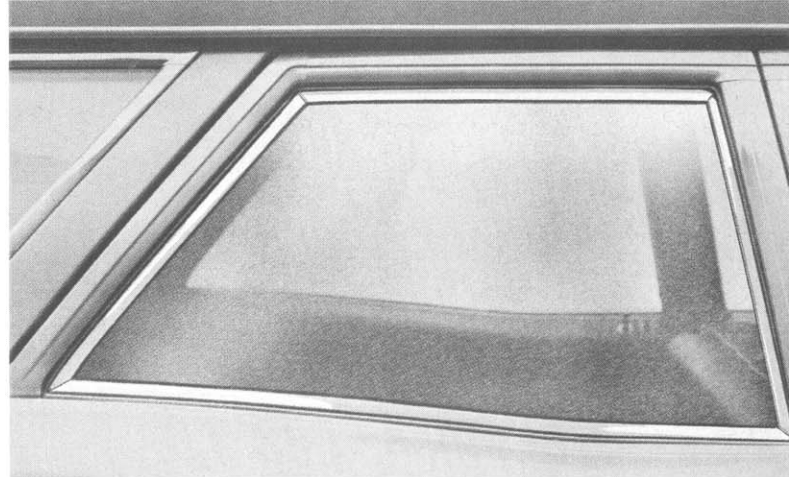

**J. Rear Door Window Screens ▲ K. Gas Cap Lock (Station Wagons only) ▼**



**CATALINA • VENTURA • 2+2**  
**STAR CHIEF EXECUTIVE**  
**BONNEVILLE • BROUGHAM • GRAND PRIX**

---

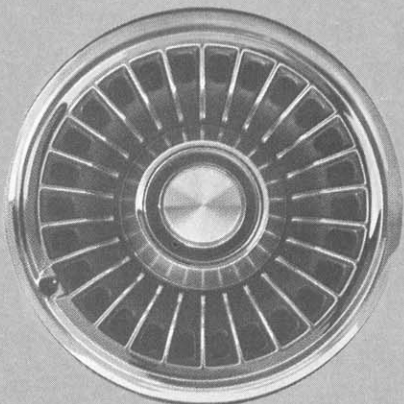

A. Deluxe Wheel Discs ▲

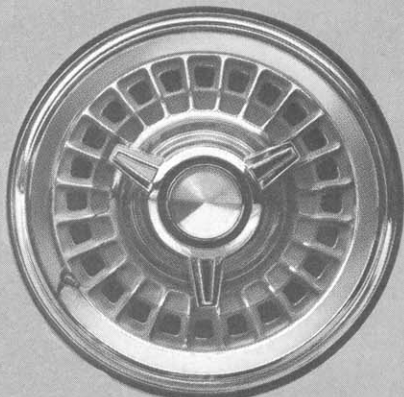

B. Custom Wheel Discs ▲

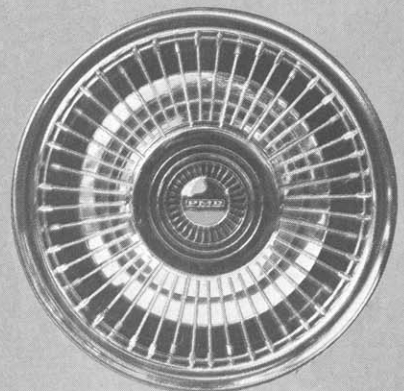

C. Wire Wheel Discs ▲

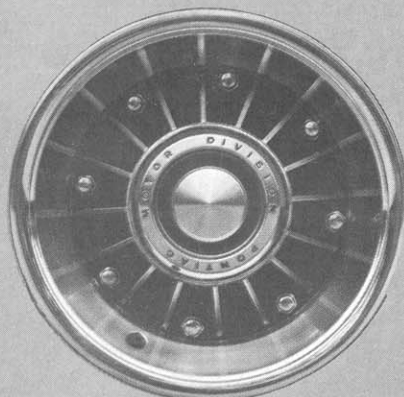

D. Aluminum Wheel Hub and Drums ▲

**A. Deluxe Wheel Discs (Code 461)**

Chrome-flashed stainless steel. Deep center section. Standard on Ventura, 2+2, Star Chief Executive, Bonneville and Grand Prix; part of Decor Group on Catalina. (F,D)

**B. Custom Wheel Discs (Code 458)**

Gives your Pontiac that well-dressed look. Made of chrome-flashed stainless steel with a 3-prong die-cast spinner. (F,D)

**C. Wire Wheel Discs (Code 452)**

For the special flair and sports car look. Gleaming wire spokes handsomely styled and structurally strong. (F,D)

**D. Aluminum Wheel Hub and Drums (Code 454)**

Distinctive 1-piece aluminum wheel hub and brake drum bonded to cast iron braking surface. Virtually immune to brake fade. (F)

**E. Reclining Bucket Seat, Right-hand Side (Code 574)**

Reclines at 45° angle. Excellent for long trips; allows front seat passenger to stretch out and relax. Includes headrest. (F) Reclining bench seat, right-hand side (Code 574) similar to above available for profile back bench seat only. (F)

**F. Headrests (Code 571)**

Available at extra cost for front seat right and left sides with any type front seating. Provides additional comfort and safety. Matches seat trim. (F)

**G. Console for Turbo Hydra-Matic Transmission on Catalina and 2+2 (Code 472)**

Available on Catalina and 2+2 series equipped with bucket seats. Features a "leather-grain" finish; trimmed in bright metal. Front area extends up into the instrument panel. (F)

**H. Console for 3-Speed or 4-Speed Manual Transmission on Catalina and 2+2 (Code 472)**

Available on Catalina and 2+2 series equipped with bucket seats. Has a "leather-grain" finish, trimmed in bright metal. The knob on both the 3- and 4-speed transmissions features a shifting diagram. (F)

**I. Console for Turbo Hydra-Matic Transmission on Bonneville and Grand Prix (Code 472)**

Standard on Grand Prix series. Available on Bonneville series equipped with bucket seats. This console is finished in rich, wood applique matching the instrument panel. (F)

**J. Console for 3-Speed or 4-Speed Manual Transmission on Bonneville and Grand Prix (Code 472)**

Available on Bonneville series with bucket seats. This console features a luxurious, wood applique surface which matches the instrument panel. The shift knob shows the shifting diagram. With the optional 4-speed transmission on Grand Prix only, a tachometer located on the instrument panel is included. (F)



E. Reclining Bucket Seat, Right-hand Side ▲

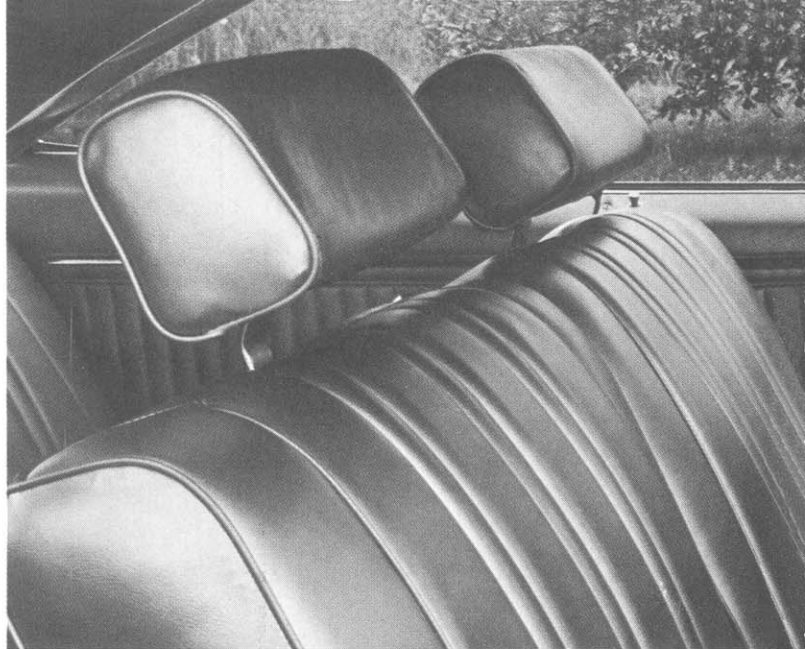

F. Headrests ▲

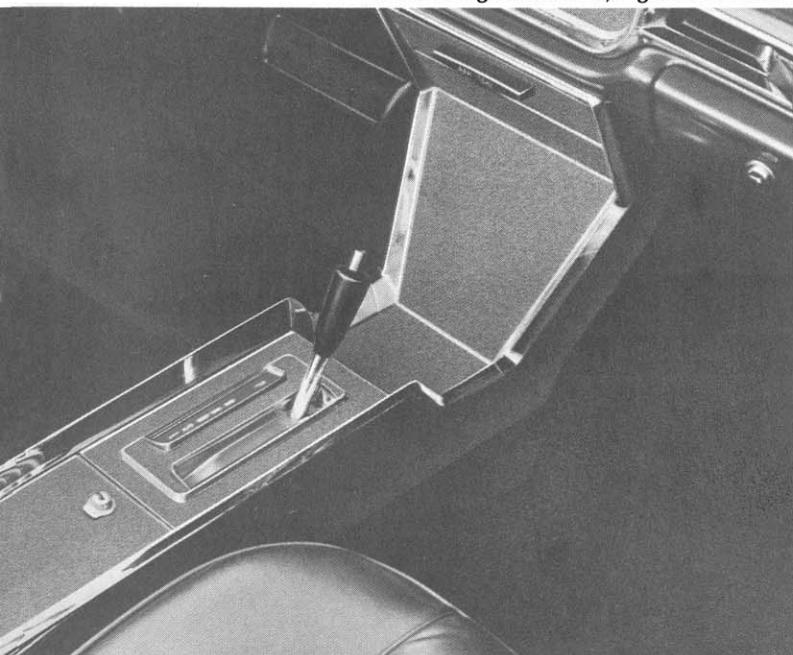

G. and H. Consoles for Catalina and 2+2 ▲▼

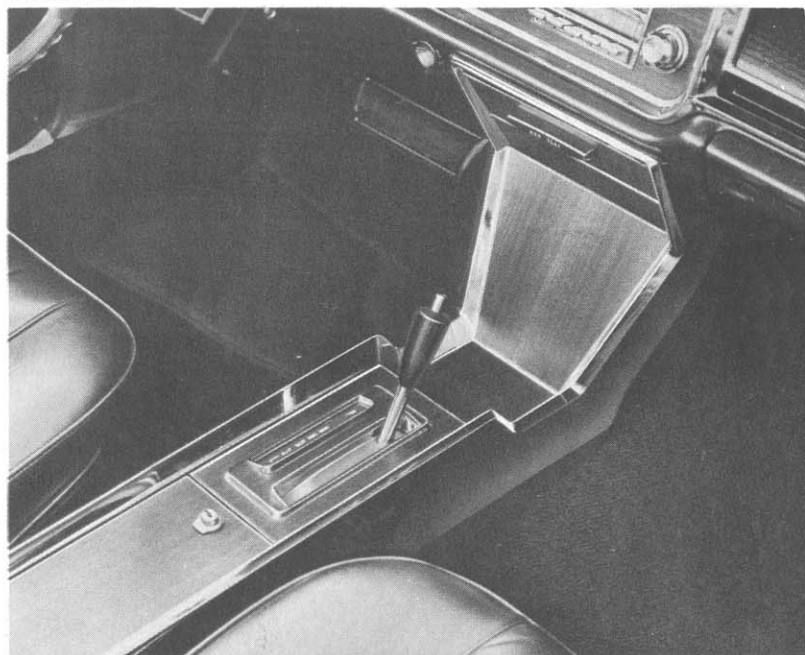

I. and J. Consoles for Bonneville and Grand Prix ▲▼

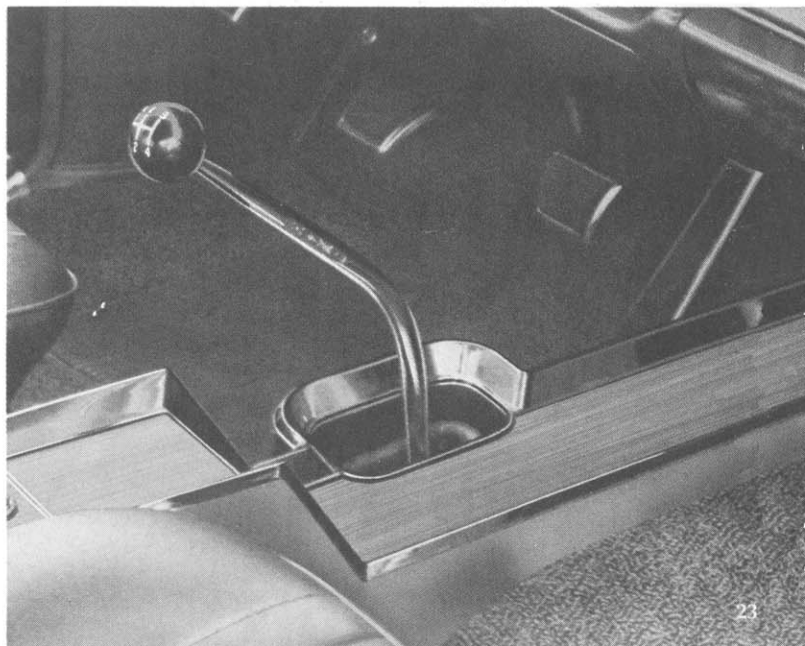
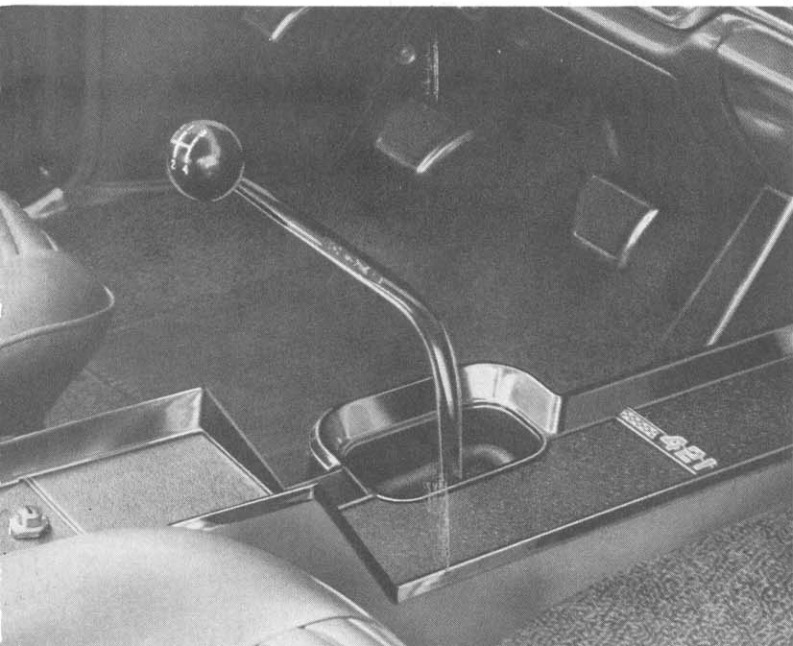



## *Basic Group (code 061)*

Push-button Radio with Manual Antenna.  
Custom Foam Front Cushion for all cars except those equipped with bucket seats or profile back bench seat.  
Electric Clock for all cars, except when equipped with Code 448 Rally Gauge Cluster and Tachometer.



## *Lamp Group (code 074)*

Luggage Compartment Lamp except on Station Wagon models.  
Glove Box Lamp.  
Roof Rail and Reading Lamp.  
Courtesy Lamp except on Convertible models.  
Ashtray and Lighter Lamp.  
Parking Brake Warning Lamp.  
Underhood Lamp (not illustrated).

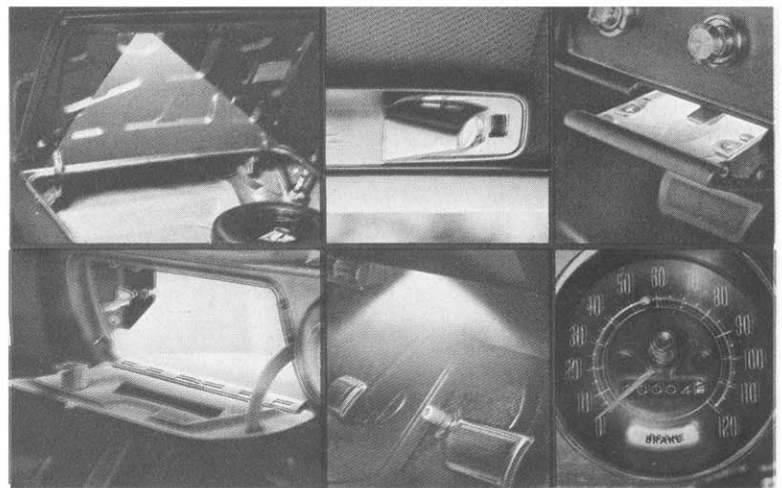

## *Decor Group (code 064)*

Deluxe Wheel Discs.  
Deluxe Steering Wheel for Tempest only.  
Decor Mouldings for Tempest and Tempest Custom only.

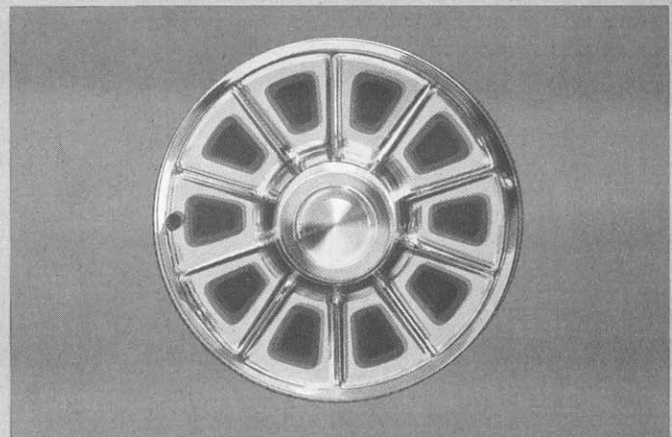
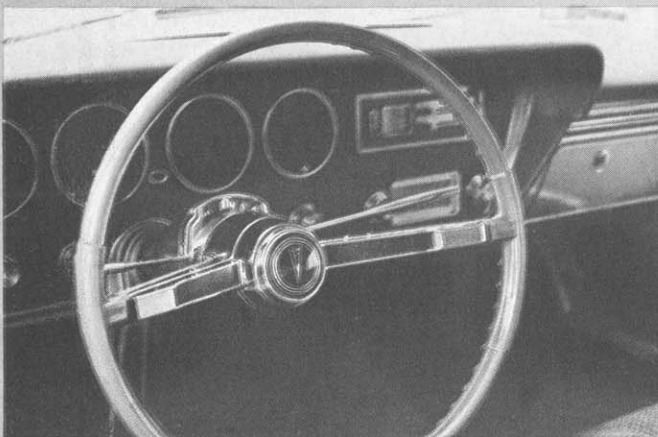

## Protection Group (code 062)

Spare Tire Cover for all models except Station Wagons.  
Rear Window Defogger for all models except Station Wagons and Convertibles.  
Door Edge Guards.  
Custom Seat Belts, Front and Rear.  
Floor Mats, Front and Rear.

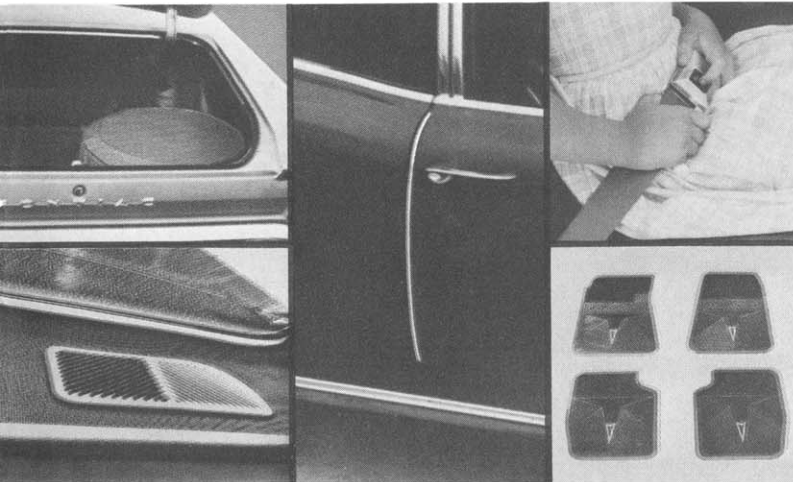

## Mirror Group (code 071)

Visor Vanity Mirror.  
Non-glare Inside Rear View Mirror.  
Outside Remote-control Mirror.

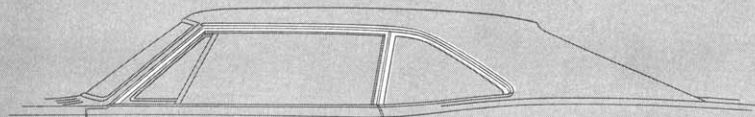
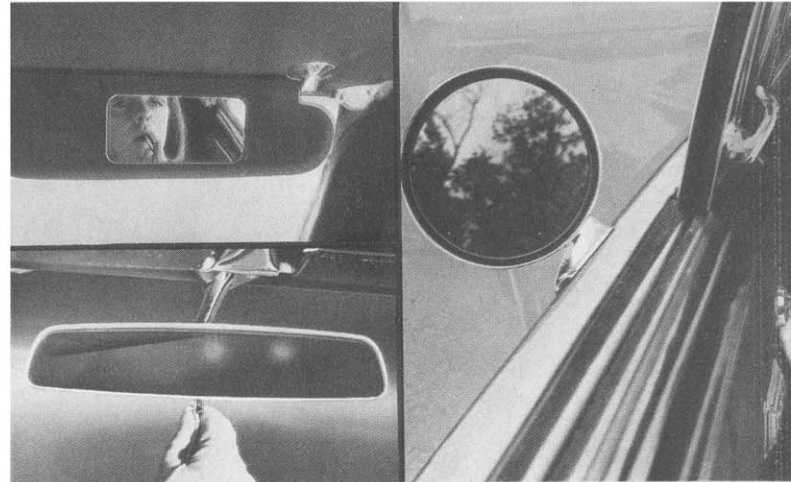

### Sports Coupe (Code 464)

Roof-drip scalp, door and quarter window mouldings. (F)

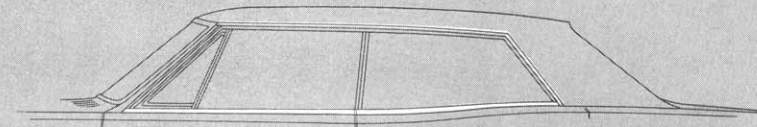

### 4-Door Hardtop (Code 464)

Roof-drip scalp and belt reveal mouldings. (F)

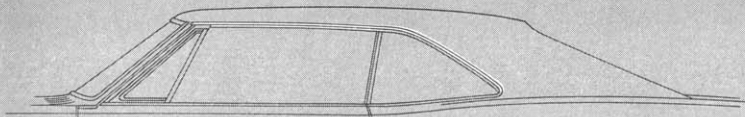

### Hardtop Coupe (Code 464)

Roof-drip scalp mouldings. (F)

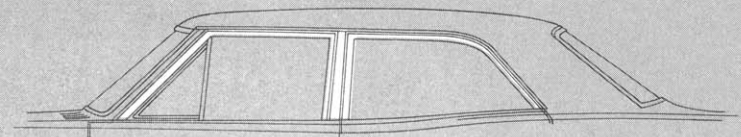

### 4-Door Sedans (Code 464)

Door window frame mouldings. (F)

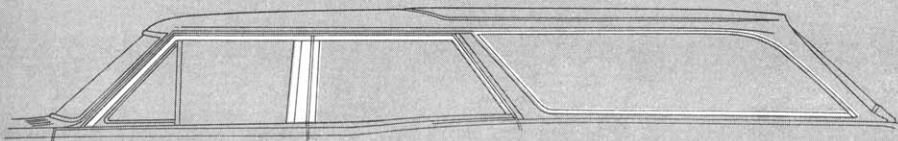

### Station Wagons (Code 464)

Door and quarter window frame mouldings. (F)

TEMPEST  
TEMPEST CUSTOM  
LE MANS • GTO

---

**A. Rear Window Defogger (Code 374)**

Blower under rear package shelf directs air through grille to rear window to remove condensation for clearer view. (Not available on Station Wagons or Convertibles.) (F,D)

**B. Custom Air Conditioner (Code 582)**

Combined with Circ-L-Aire heater gives full range of comfort control for any weather . . . heats or cools air, controls humidity, removes pollen from air. Permits riding in cool, clean, noise-free comfort when it's hot, dusty and noisy outside. (F,D)

**C. Ventshades**

Fit snugly over top of side windows. Help protect occupants from sun and rain when windows are slightly open. Not available for Convertibles or Hardtops. (D)

**D. Soft-Ray Glass (Code 531)**

All windows fully tinted except convertible back window for reduced glare, with upper windshield area shaded for added glare reduction. Reduced eye strain permits added comfort. Recommended with air conditioning. (Code 532) Also available for windshield only. (F)

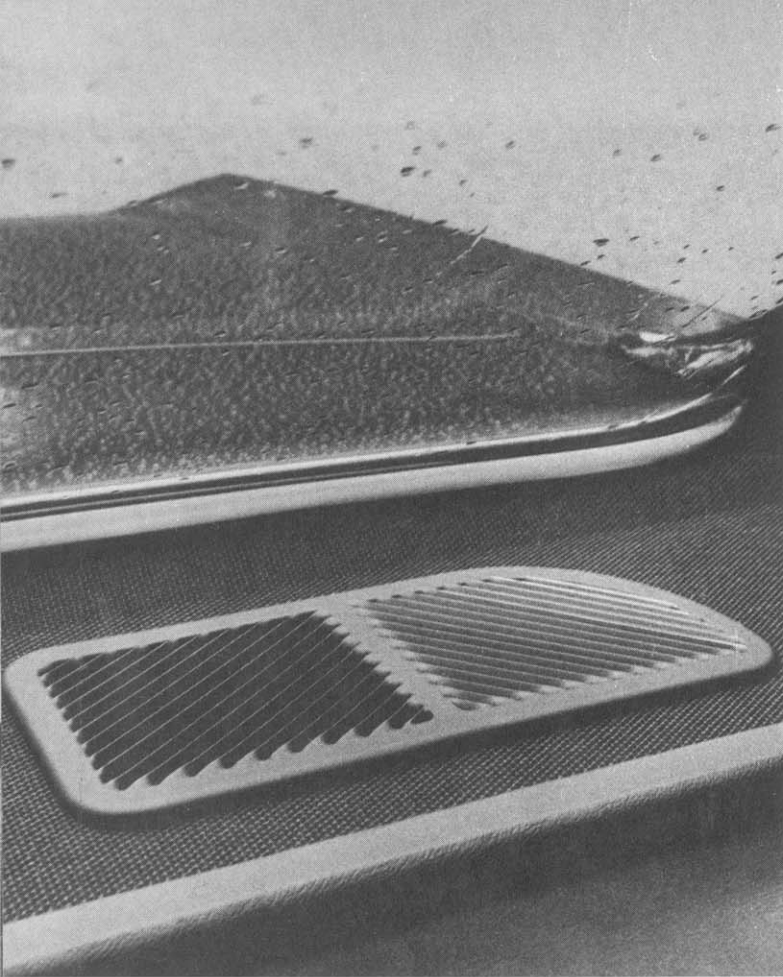

A. Rear Window Defogger ▲

B. Custom Air Conditioner ▼

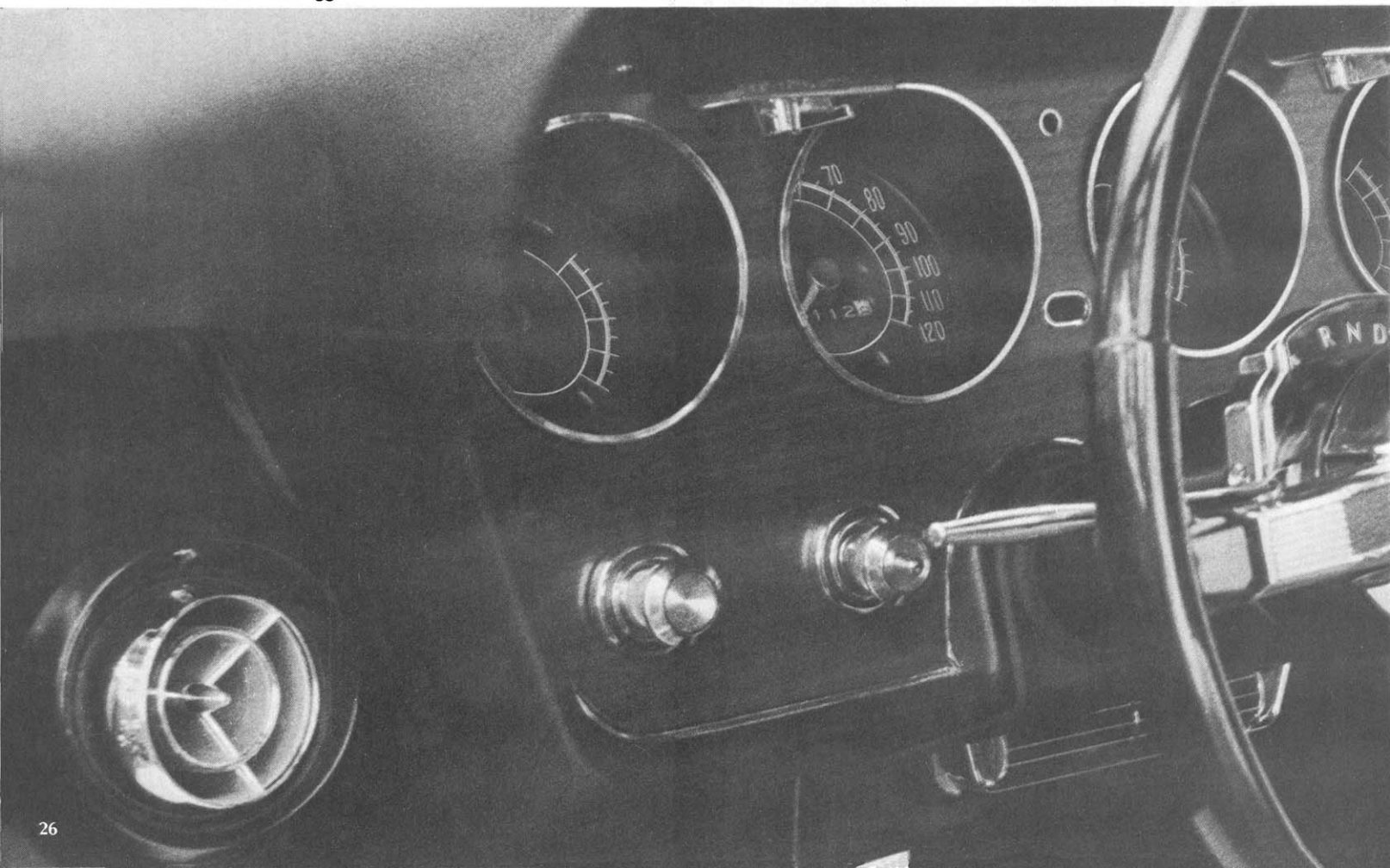

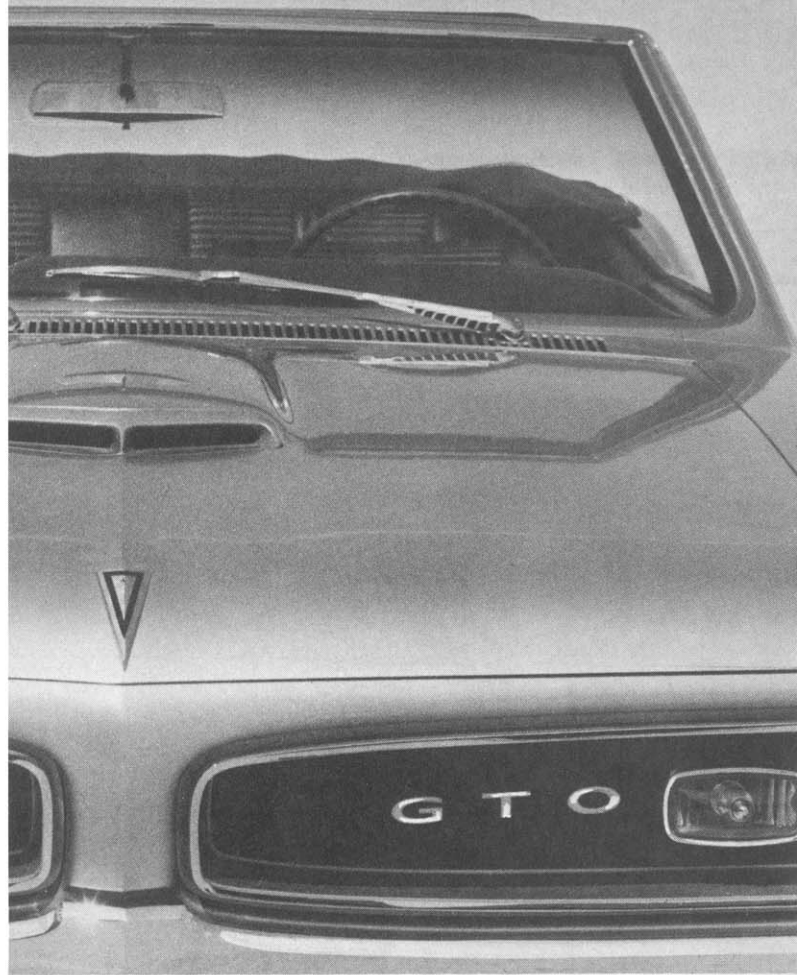

C. Ventshades ▲ D. Soft-Ray Glass ▲

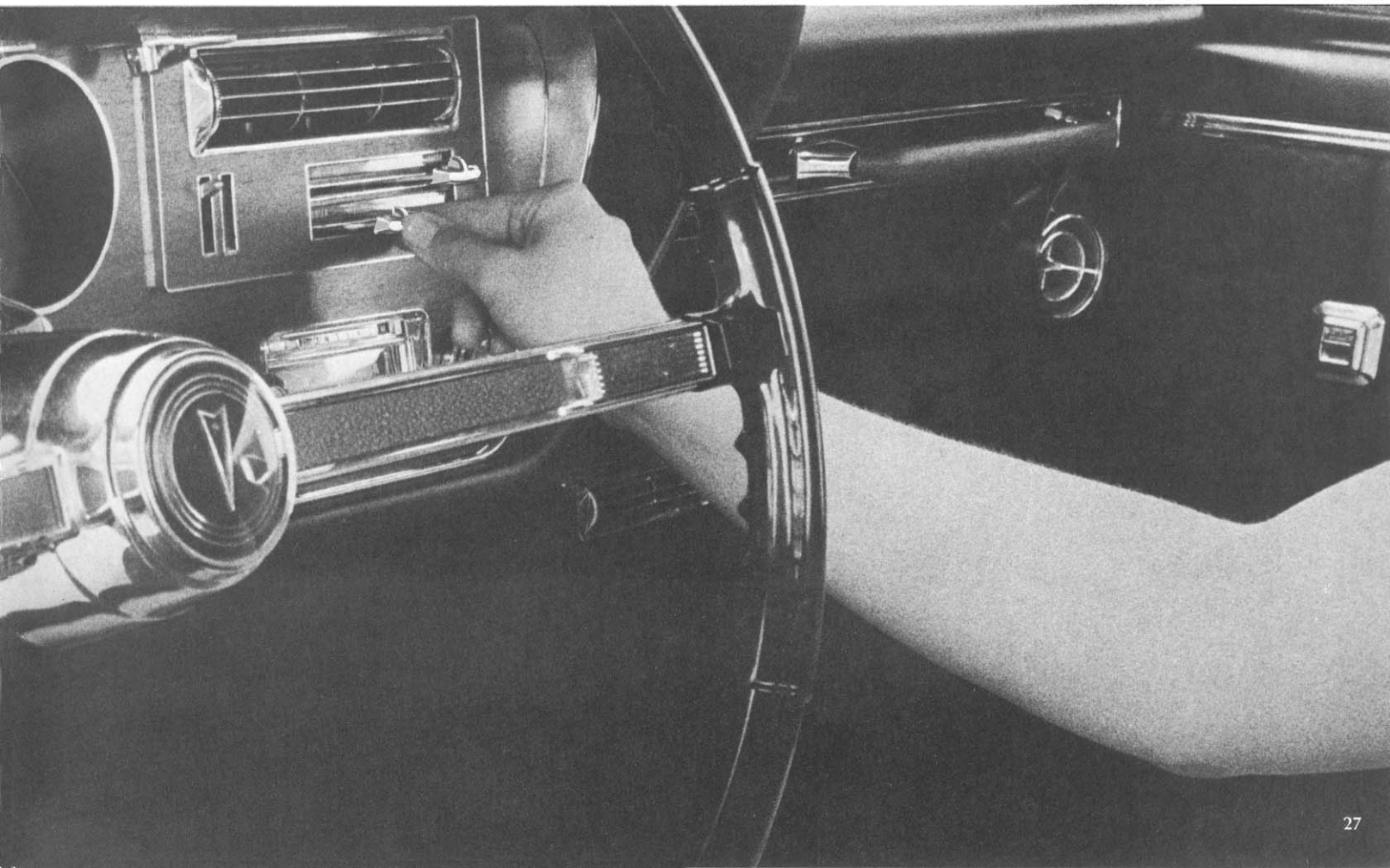

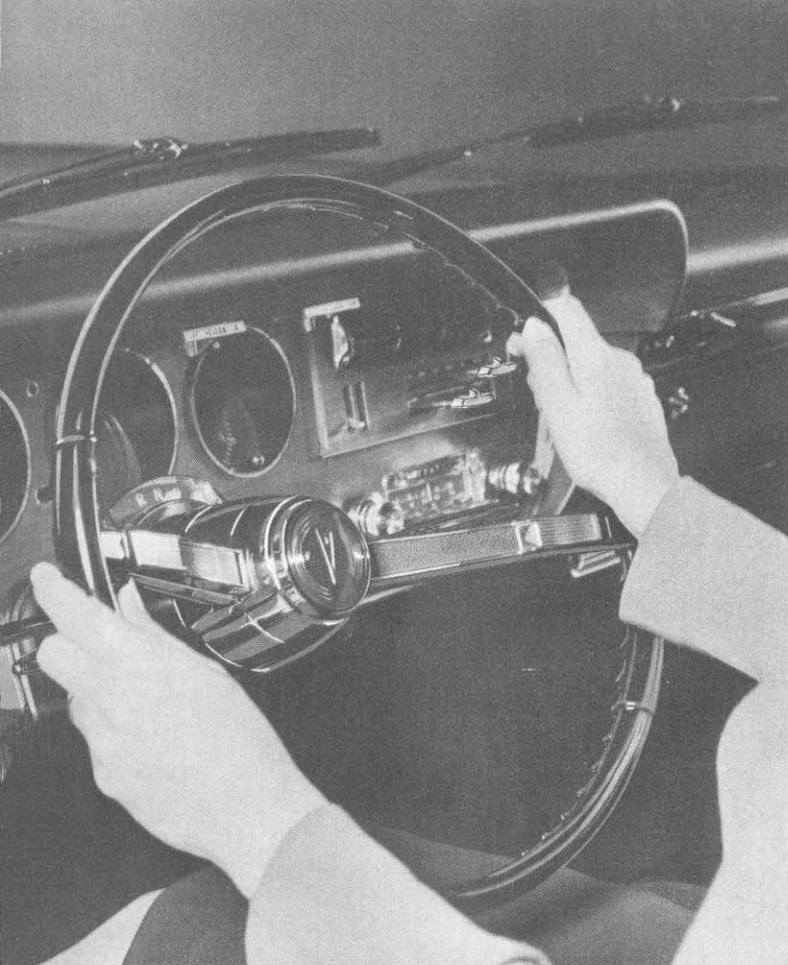

A. Power Steering ▲

B. Power Brakes ▼

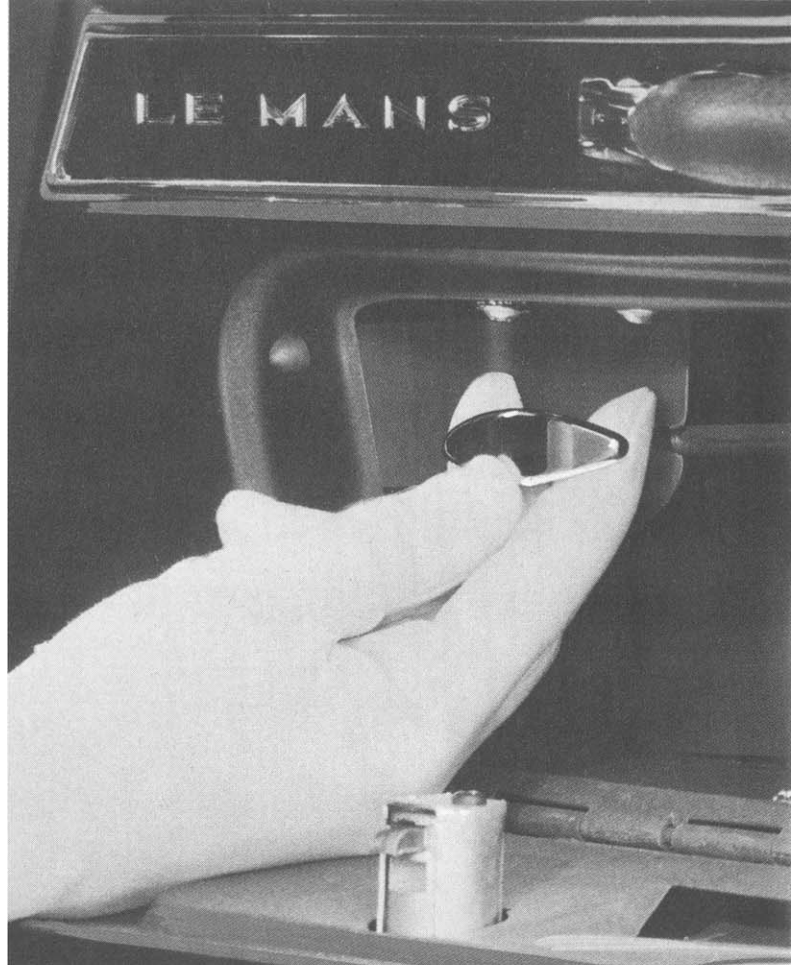

C. Rear Deck Lid Release ▲

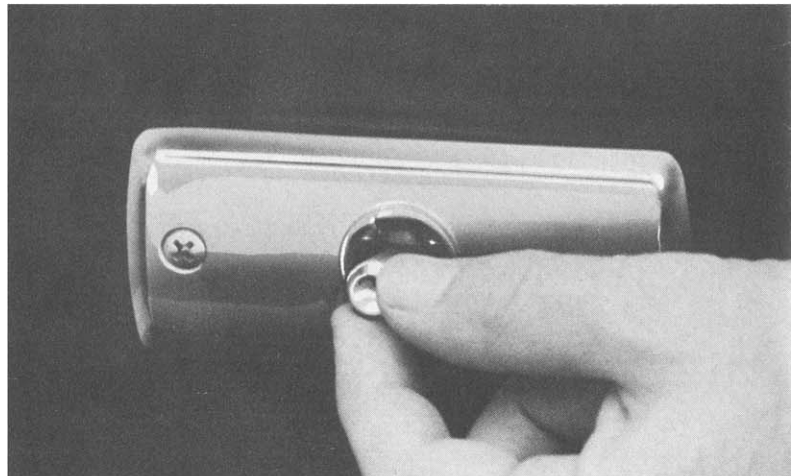
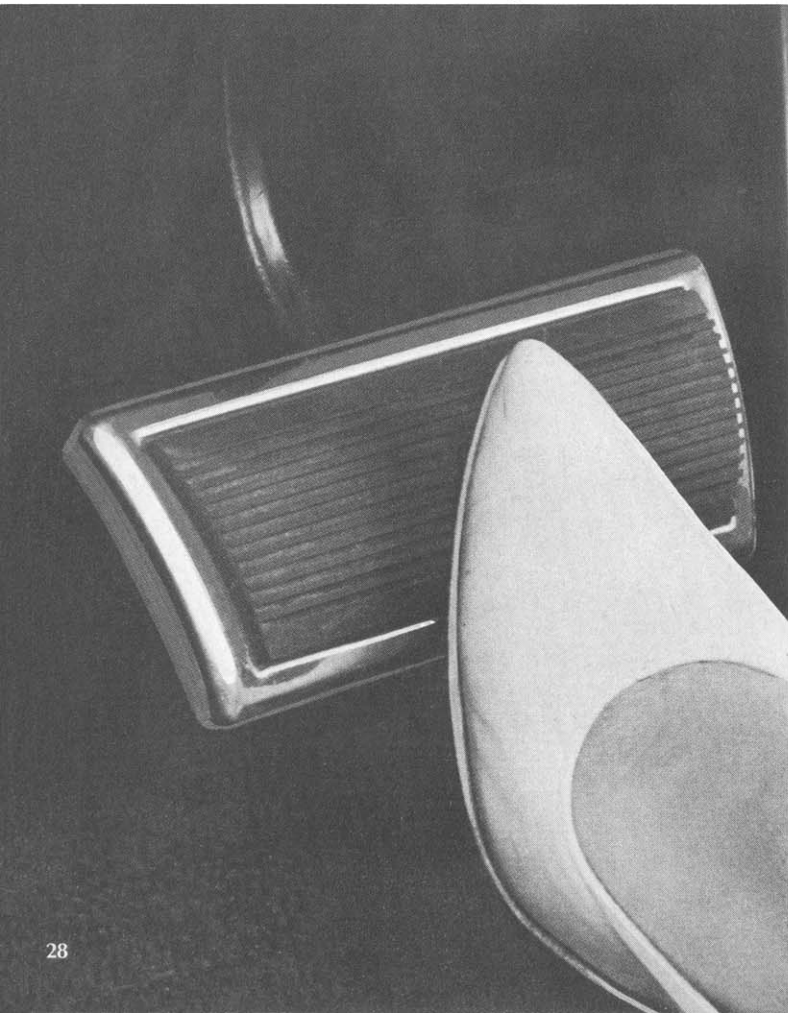

D. Power 4-Way Bench Seat ▲

E. Power Bucket Seat ▼

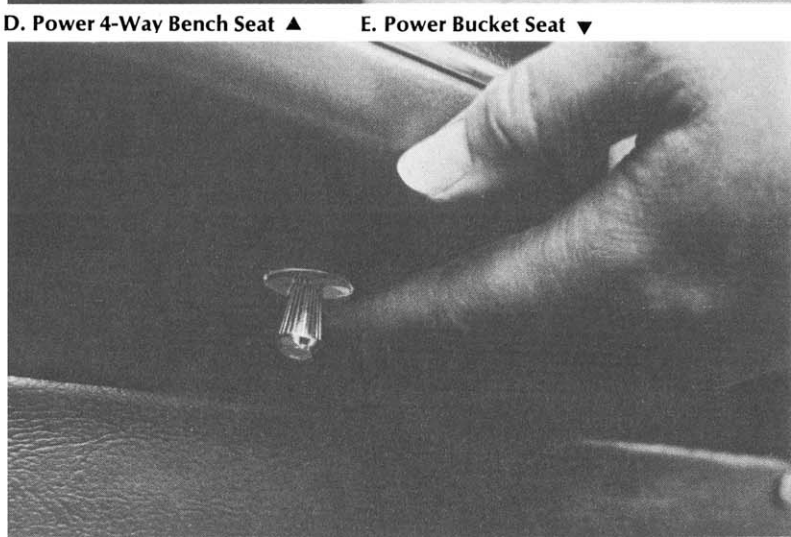

TEMPEST  
TEMPEST CUSTOM  
LE MANS • GTO

---

**A. Power Steering (Code 501)**

Drive, turn, park with ease. One to two pounds effort sufficient for steering yet retains feel of control. (F,D)

**B. Power Brakes (Code 502)**

Positive braking with light touch of toe. Includes bright metal trim on brake and accelerator pedal when factory installed. (F,D)

**C. Rear Deck Lid Release (Code 422)**

Provides the conveniences of opening trunk from the driver's seat. Manual control located inside glove box. Trunk may also be opened by key. All models except Station Wagons. (F,D)

**D. Power 4-Way Bench Seat (Code 561)**

Variable seat positions for greater comfort and safer driving. Makes it easier for tall or short person to conveniently drive same car. Available full-width seat only. (F)

**E. Power Bucket Seat (L.H. only) (Code 564)**

Moves seat forward, backward—raises and lowers rear of seat to positions for greater driving comfort. (F)

**F. Power Convertible Top (Code 542)**

Take top down or put it up without leaving driver's seat. Control on instrument panel. Optional on Tempest Custom Convertible. Standard on Le Mans and GTO Convertibles. (F)

**G. Rear Door Safety Lock**

Prevents children from opening rear door. When lock button is pushed down, rear doors can't be opened without inserting key into lock button. (D)

**H. Power Windows (Code 551)**

For remote control of all vertical side windows from single control on driver's door. Individual control at each window. (F)



F. Power Convertible Top ▲

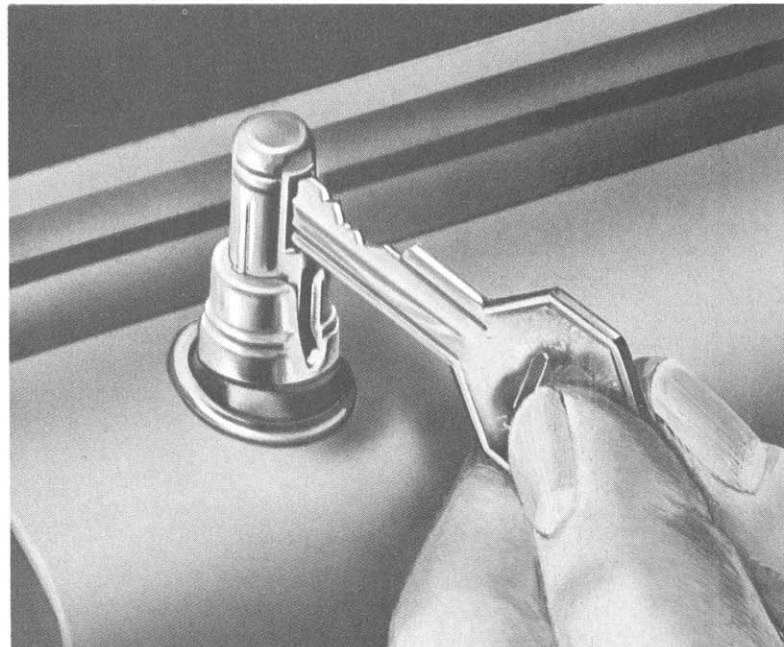

G. Rear Door Safety Lock ▲ H. Power Windows ▼

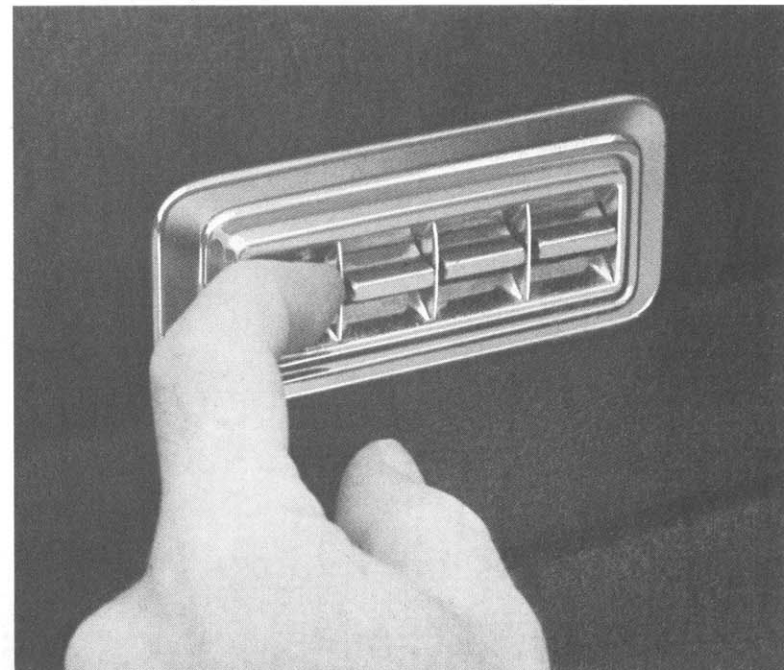

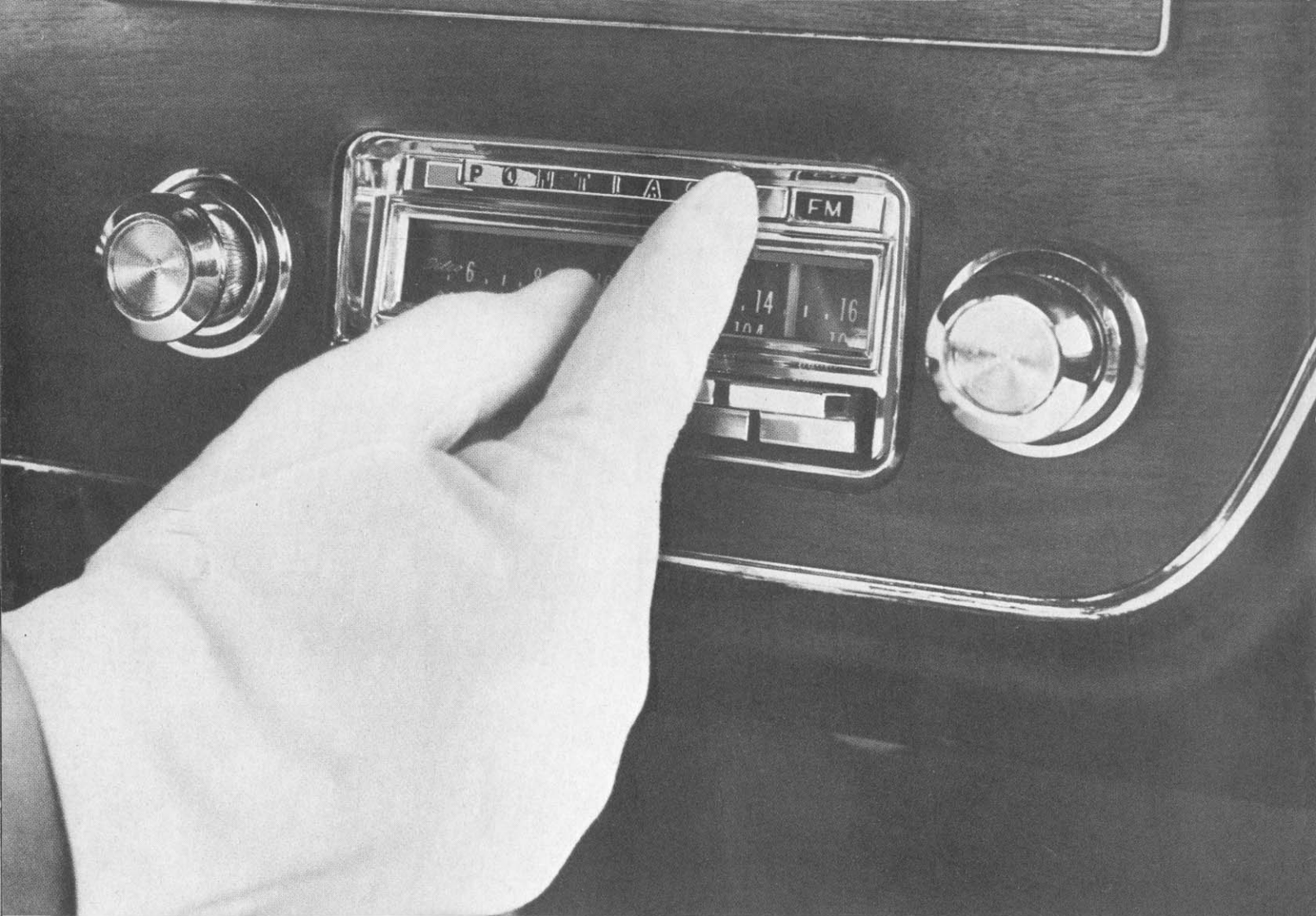

A. Push-button AM-FM Radio ▲

B. Push-button Radio ▼

C. Manual Control Radio ▼

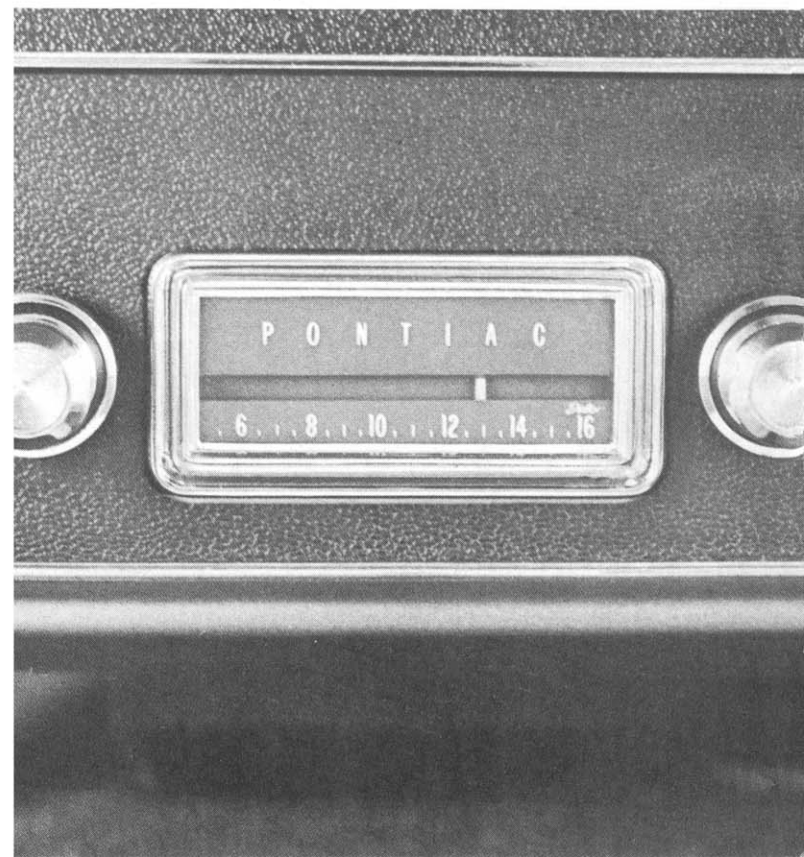

TEMPEST  
TEMPEST CUSTOM  
LE MANS • GTO

---

**A. Push-button AM-FM Radio with Manual Antenna .  
(Code 344)**

Offers dual listening enjoyment on either FM or AM frequencies. Completely transistorized. Push buttons can be set to either AM or FM or combination of both. Unusually fine quality and fidelity. (F,D)

**B. Push-button Radio & Manual Antenna (Code 342)**

Superior tone and fidelity. Completely transistorized. Wide dial provides space for precise tuning. (F,D)

**C. Manual Control Radio and Manual Antenna  
(Code 348)**

Completely transistorized. Excellent tone quality and fidelity. Wide dial for precise tuning. (F,D)

**D. Rear Speaker (Code 351)**

Brilliant tone and depth control. 3-step switch lets you play front, rear or both speakers. All models except Convertibles. (F,D)

**E. Verbra-Phonic Rear Speaker System (Code 352)**

Fine reverberation-quality listening. Brilliant tone simulates acoustics in an auditorium when both speakers are operating. 3-step switch lets you play through front, rear or both speakers. All models except Station Wagons and Convertibles. (F,D)

**F. Electric Power Antenna**

Available with all radios. Raised or lowered by switch on instrument panel. Mounted on right rear fender on all models. Not available on Station Wagons. (F,D)



D. Rear Speaker ▲

E. Verbra-Phonic Rear Speaker System ▼

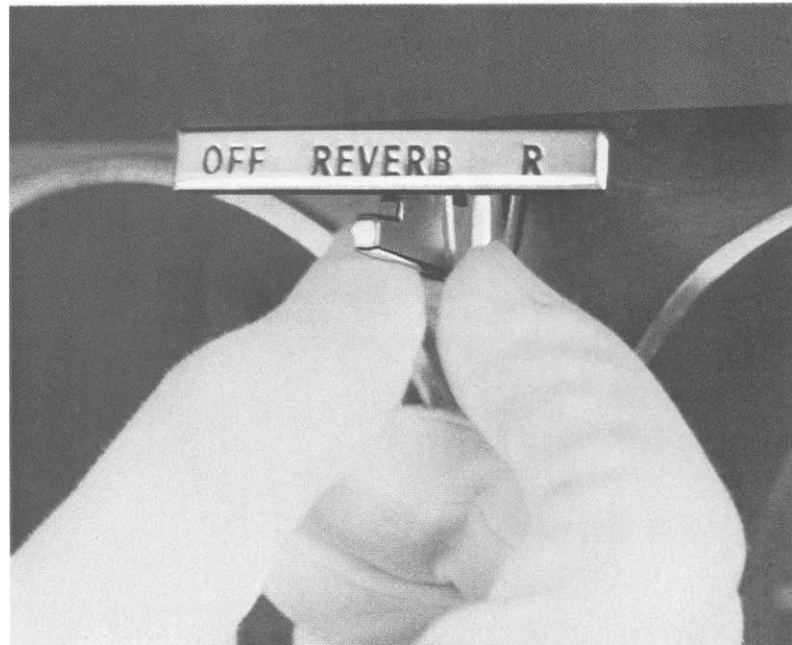

F. Electric Power Antenna ▼





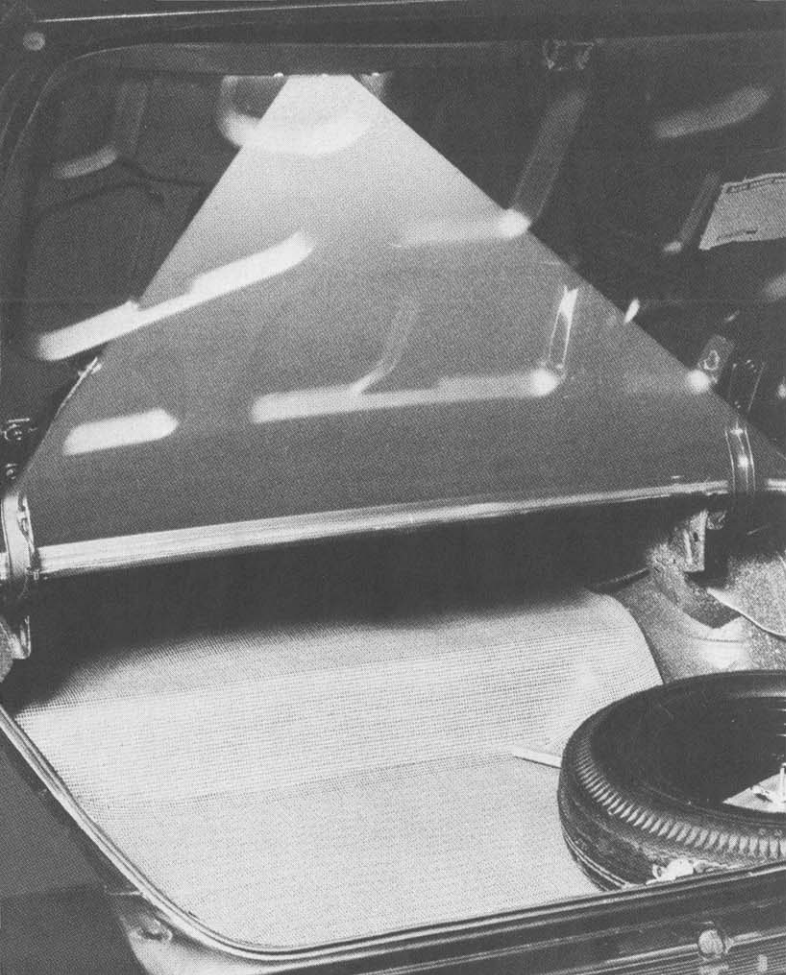

A. Luggage Lamp ▲

B. Side Roof Rail and Reading Lamps ▼

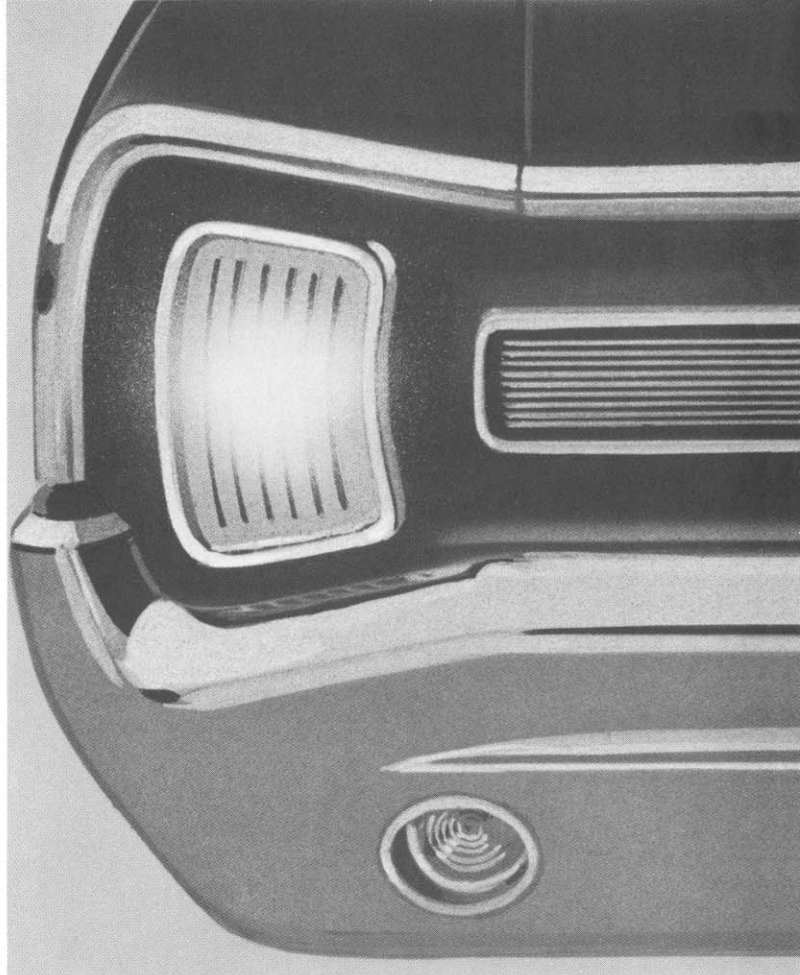

C. Hazard Flasher ▲

D. Safeguard Speedometer - Fuel Warning Lamp ▼

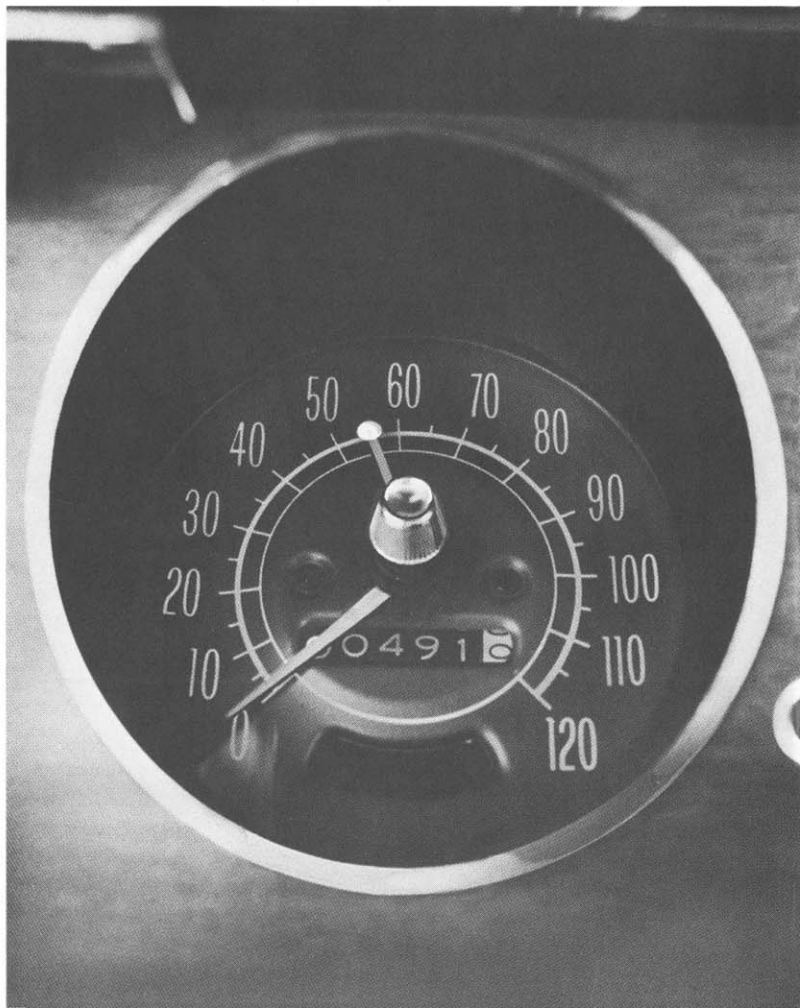
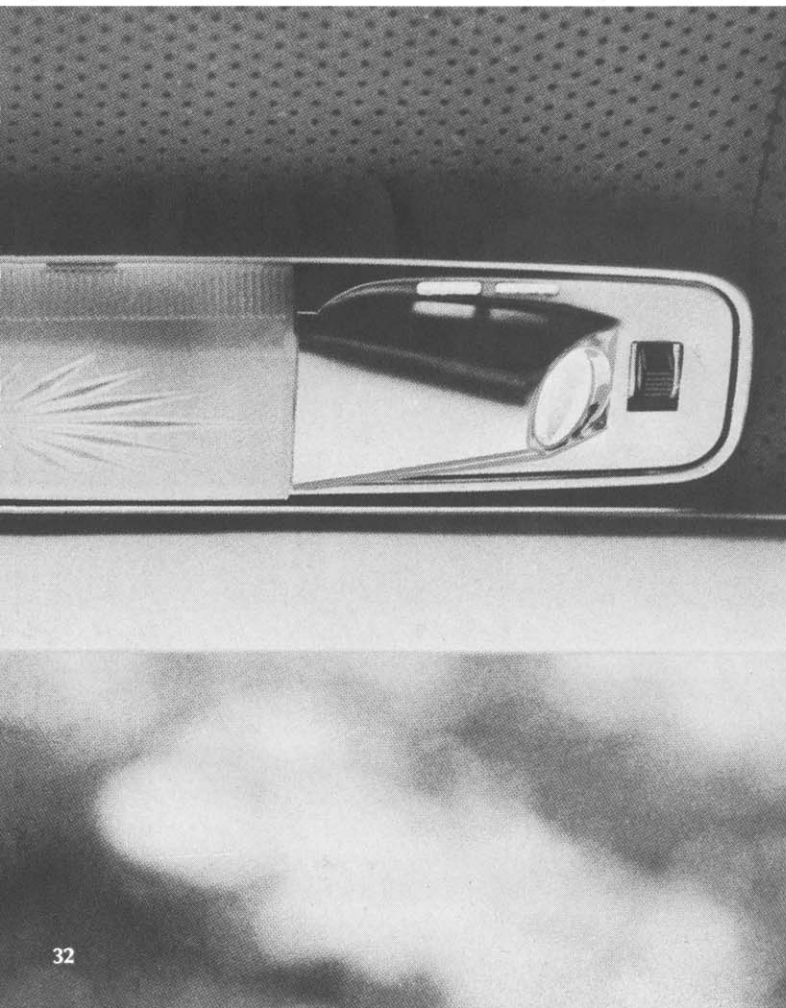

TEMPEST  
TEMPEST CUSTOM  
LE MANS • GTO

---

**A. Luggage Lamp (Code 401)**

Lights automatically when trunk is lifted. Permits free use of both hands for loading or unloading luggage. (Not available on Station Wagons). (F,D)

**Underhood Lamp (Code 421)**

Unit similar to luggage lamp but located under engine hood . . . available on all models. (F,D) (Not illustrated)

**B. Side Roof Rail and Reading Lamps (Code 404)**

Mounted on interior side of roof rails, one lamp on each side. Light up when door is opened. Each lamp has an individual switch. Not available on Convertibles. (F)

**C. Traffic Hazard Warning Flasher Switch (Code 521)**

Parking lamps and stop lamps flash on and off repeatedly. Excellent precaution for emergency off-highway stops. (F,D)

**D. Safeguard Speedometer and Fuel Warning Lamp (Code 441)**

Warns of excess speed and low fuel. Control knob lets you select desired speed limit. Buzzer signals when car exceeds this speed. Not available with Rally Gauge Cluster. (F)

**E. Parking Brake Warning Lamp (Code 414)**

Mounted on instrument panel to show red light when ignition is turned on and parking brake is set. Lamp stays on until brake is fully released. (F,D)

**F. Glove Compartment Lamp (Code 402)**

Lights automatically when glove compartment door is opened. (F,D)

**G. Ashtray and Lighter Lamps (Code 412)**

Glow automatically when parking lamps or head lamps go on. Plainly seen when ashtray is pulled out or when lighter is removed. (F,D)

**H. Instrument Panel Courtesy Lamp (Code 411)**

Lights when front door is opened. Also manually operated by instrument panel switch. Located under instrument panel. Standard on Convertibles. (F,D)



**E. Parking Brake Warning Lamp ▲**

**F. Glove Compartment Lamp ▼**

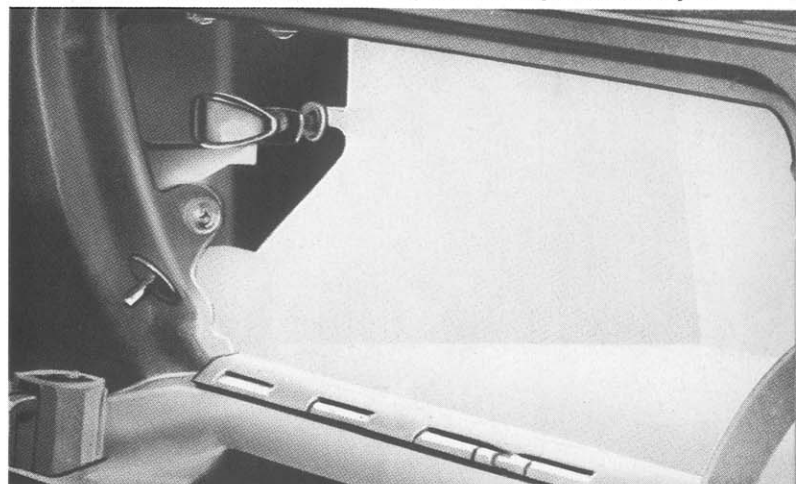

**G. Ashtray and Lighter Lamps ▼**

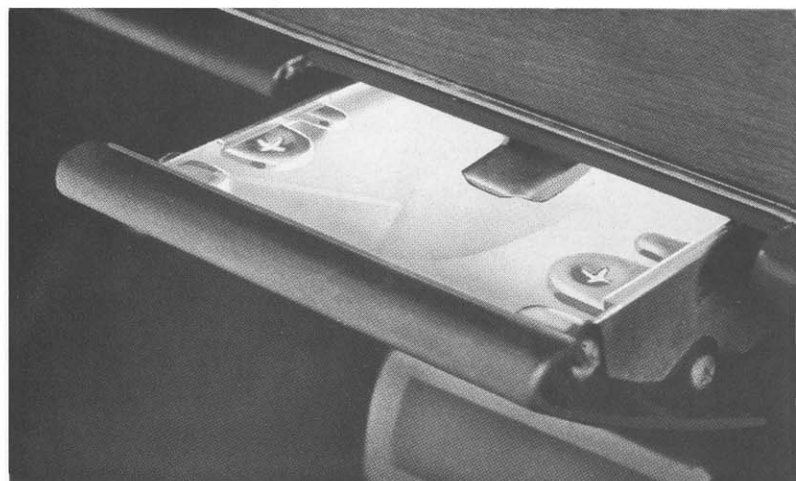

**H. Instrument Panel Courtesy Lamp ▼**





A. Remote-control Outside Mirror ▲

B. Visor Vanity Mirror ▼



C. Non-glare Inside Rearview Mirror ▼

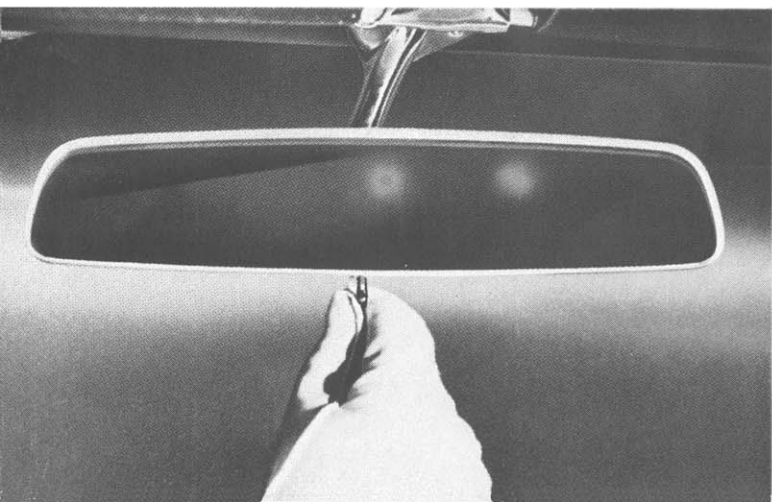

TEMPEST  
TEMPEST CUSTOM  
LE MANS • GTO

---

**A. Remote-control Outside Mirror (Code 394)**

Mounts on left-hand door. Easily adjusted from inside car. Provides sharp, clear image. (F, D)

**B. Visor Vanity Mirror (Code 391)**

Mounts on back of visor. Out of sight when not in use. Ideal for checking makeup, combing hair, etc. (F,D)

**C. Non-glare Inside Rearview Mirror (Code 392)**

Has special finger knob to permit easy adjustment to non-glare or nighttime driving position. (F,D)

**D. Custom Front and Rear Seat Belts with Retractors (Code 431)**

On 4-door models—custom seat belts with retractors in both front and rear . . . on 2-door models—custom seat belts with retractors on front seat, custom seat belts less retractors on rear seat. Push-button on buckle releases belt which then retracts into housing when not in use. Seat belt colors harmonize with interiors. (F)



D. Custom Front and Rear Seat Belts ▲

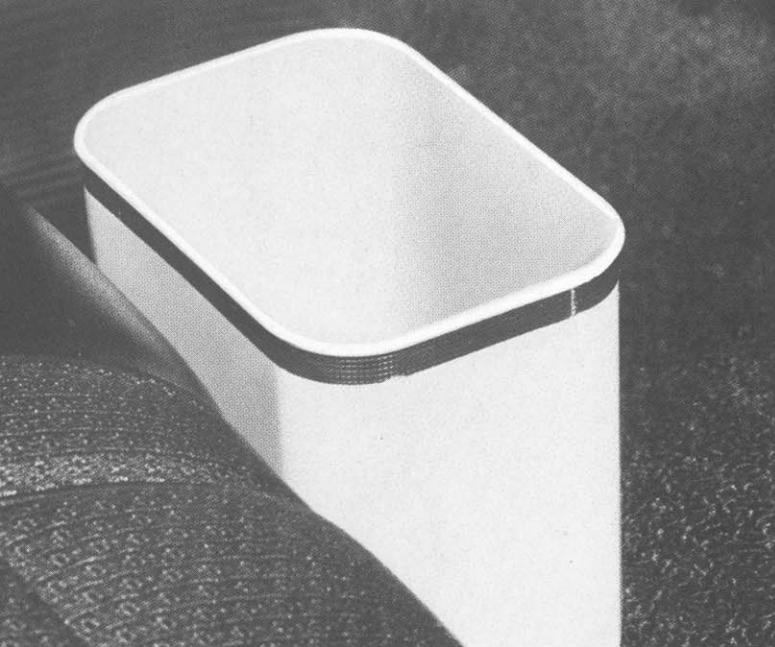

A. Litter Basket ▲

B. Chrome Tissue Dispenser ▼



C. Engine Block Water Heater ▼

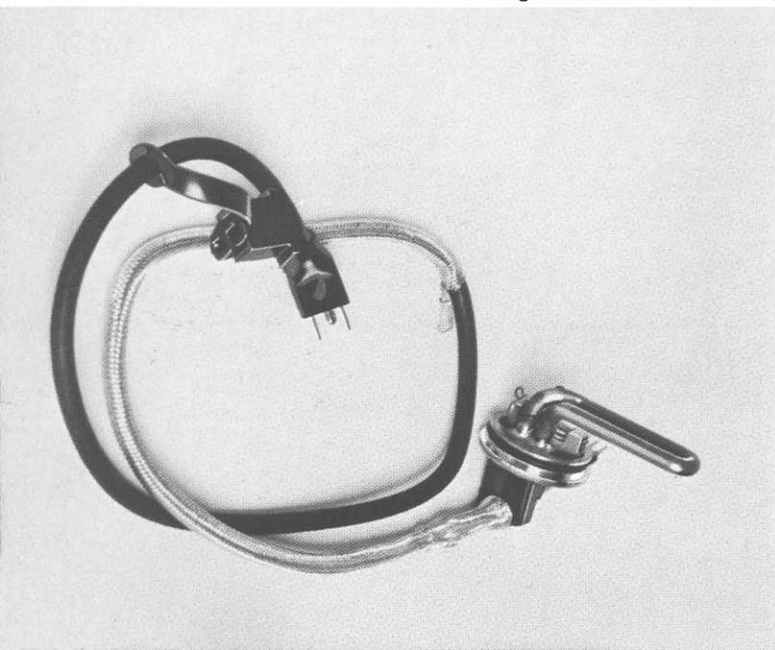

TEMPEST  
TEMPEST CUSTOM  
LE MANS • GTO

---

**A. Litter Basket**

Available in red, blue, black or beige to harmonize with car interior. Clings to transmission tunnel, weighted to prevent tipping. Easily removed for emptying. (D)

**B. Chrome Tissue Dispenser**

Holds regular size tissue box. Swings out for use, swings back and locks in place when not in use. (D)

**C. Engine Block Water Heater**

Electric pre-heater for engine coolant provides fast, effortless engine starts, quick heater action during severe cold. Single unit raises engine coolant overnight from 0°F. to 50°F., dual unit to about 90°F. Operates from standard 110 v house electrical outlet. (D)

**D. Tonneau Cover**

Protects convertible interior from rain or hot sun when top is down. Sturdy vinyl snaps off or on in a jiffy. Has zipper opening for single occupancy of driver. (D)

**E. Spare Tire Lock**

Prevents theft of spare tire and wheel in trunk. (D)

**F. Spare Tire and Wheel Cover (Code 372)**

Protects trunk contents and tire. Slips on, off easily. Dresses up luggage compartment. (All models except Station Wagons.) (F,D)

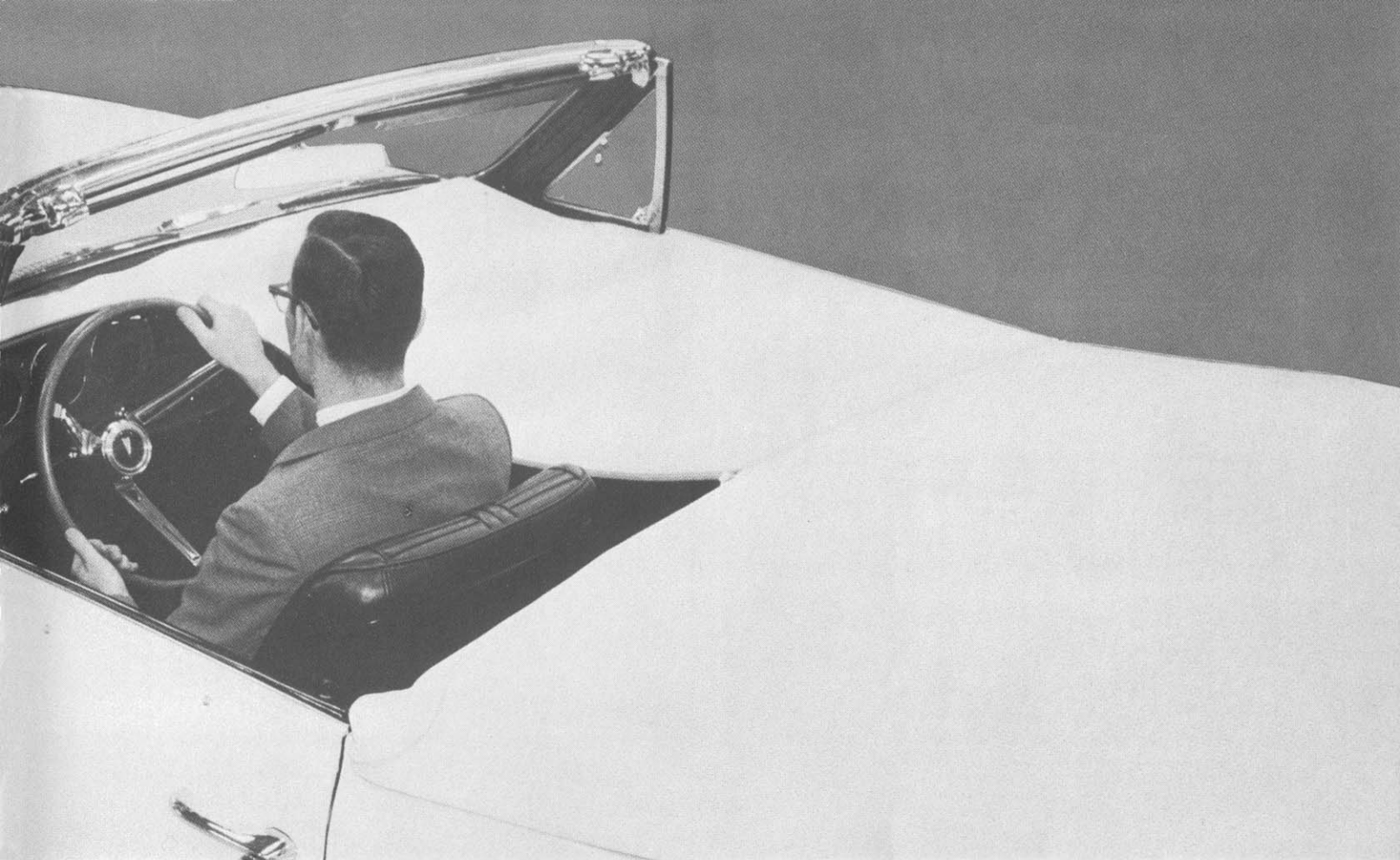

D. Tonneau Cover ▲

E. Spare Tire Lock ▼

F. Spare Tire and Wheel Cover ▼

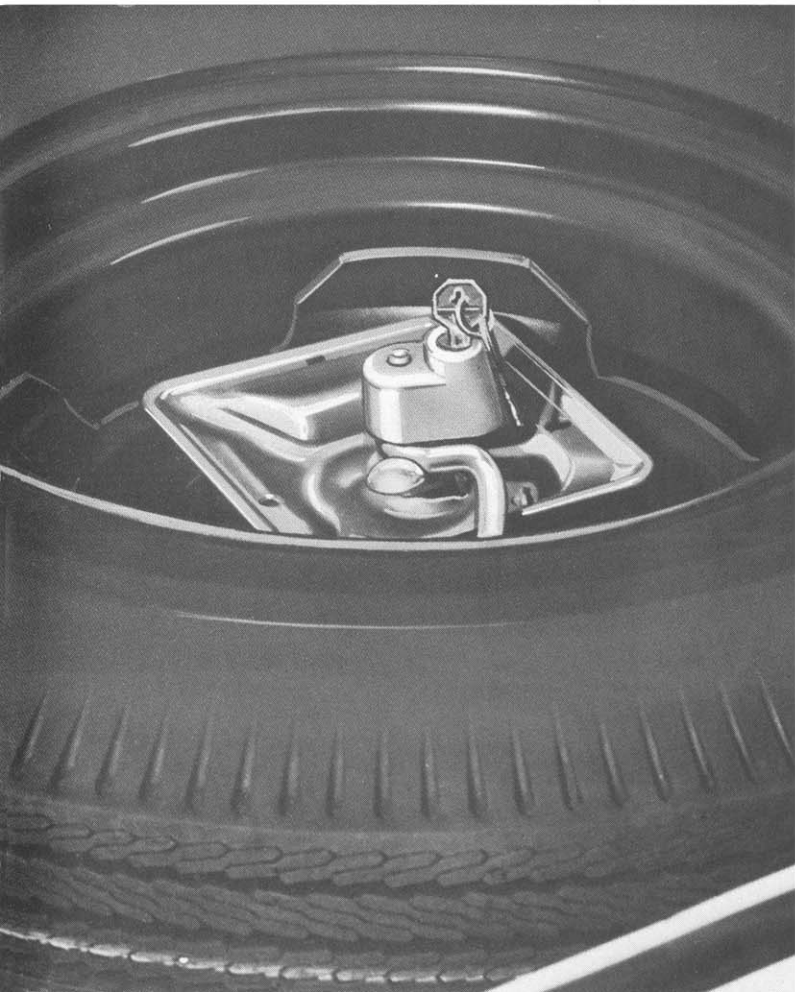

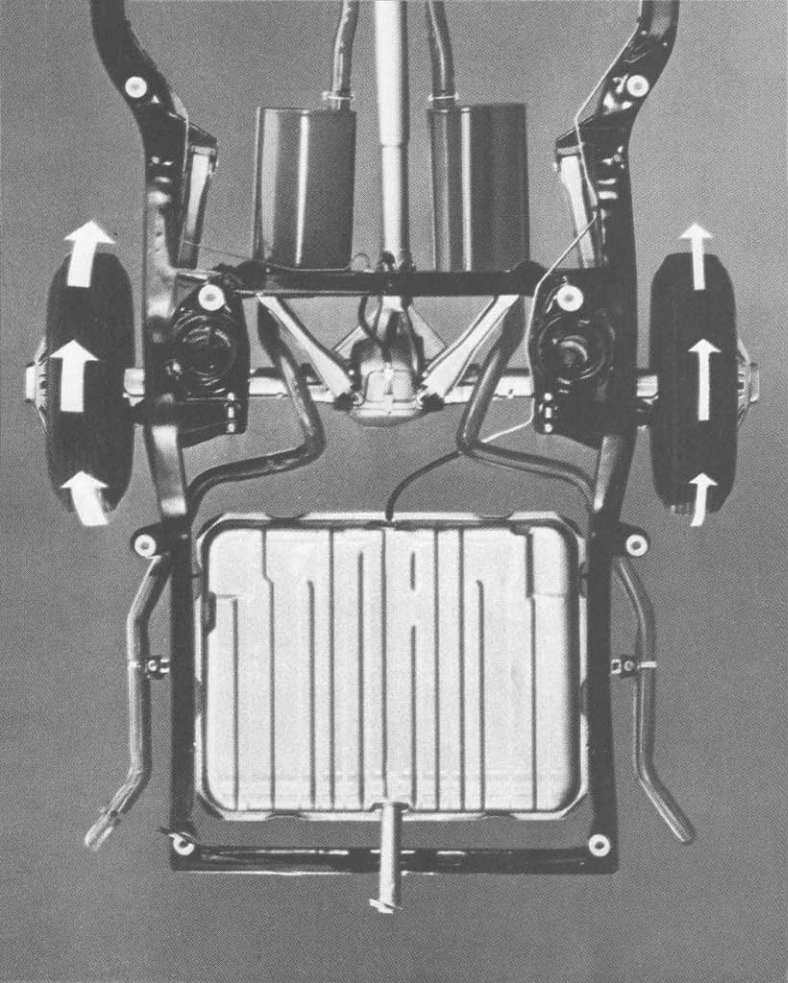

A. Safe-T-Track Differential ▲

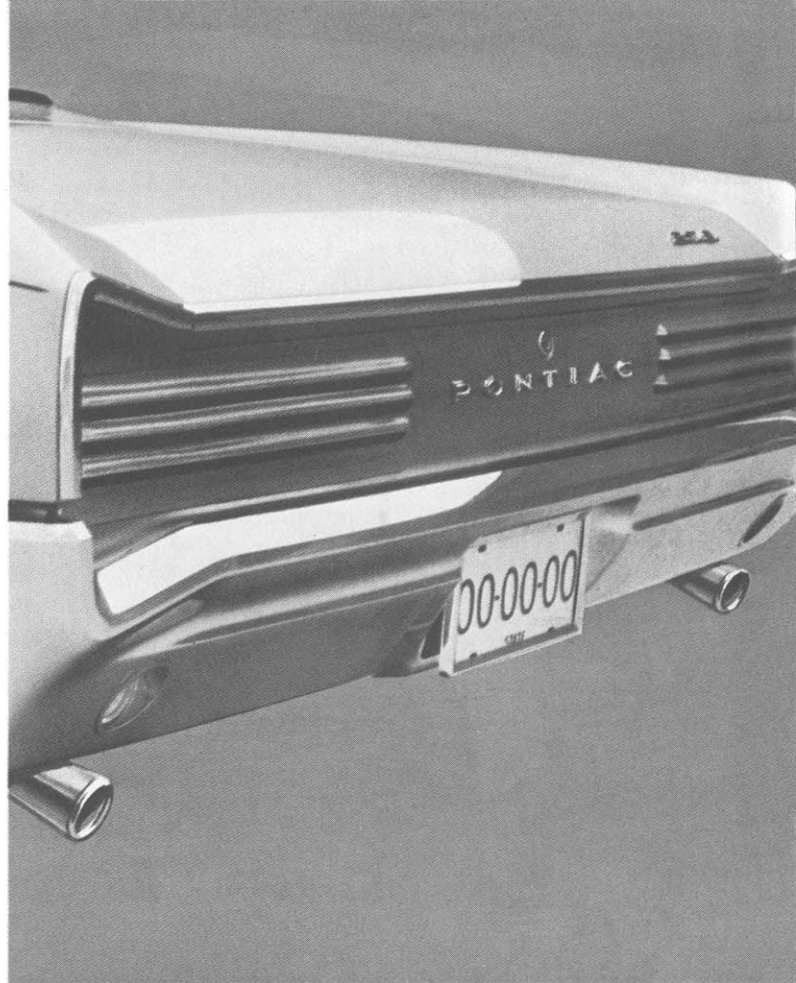

C. Exhaust Tailpipe Extensions ▲

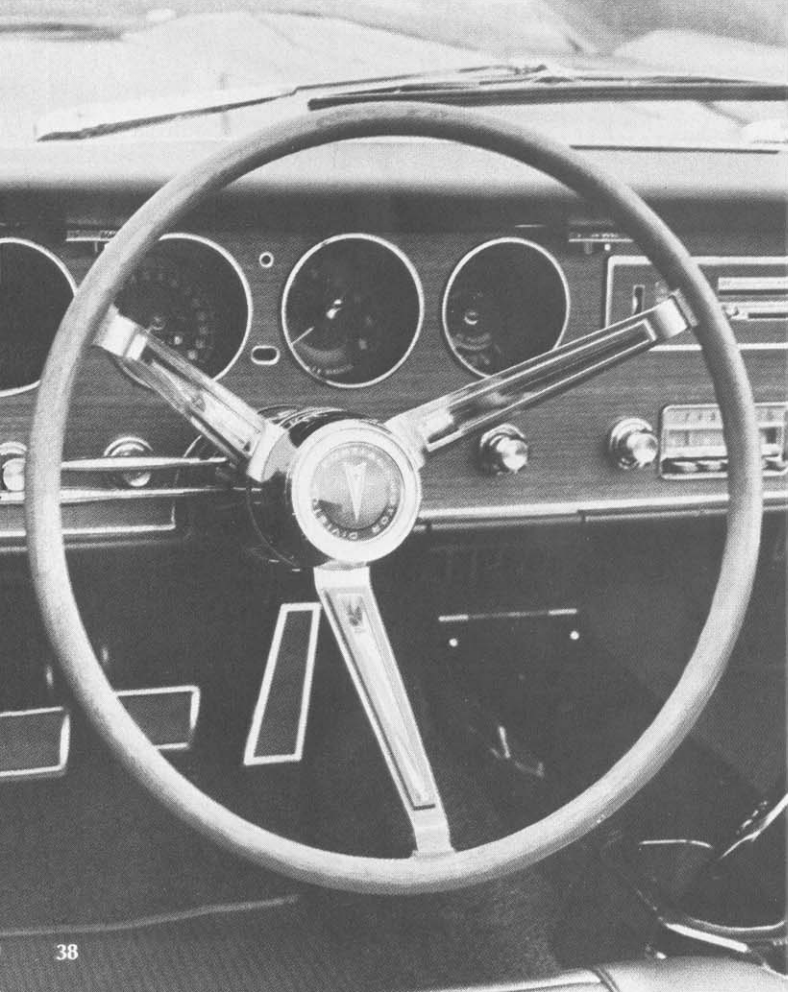

B. Custom Sports Steering Wheel ▼

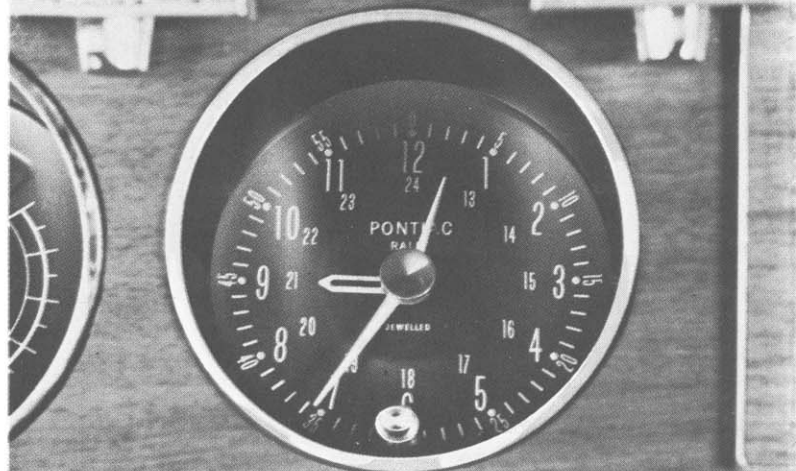

D. Rally Clock ▲

E. Rally Cluster ▼

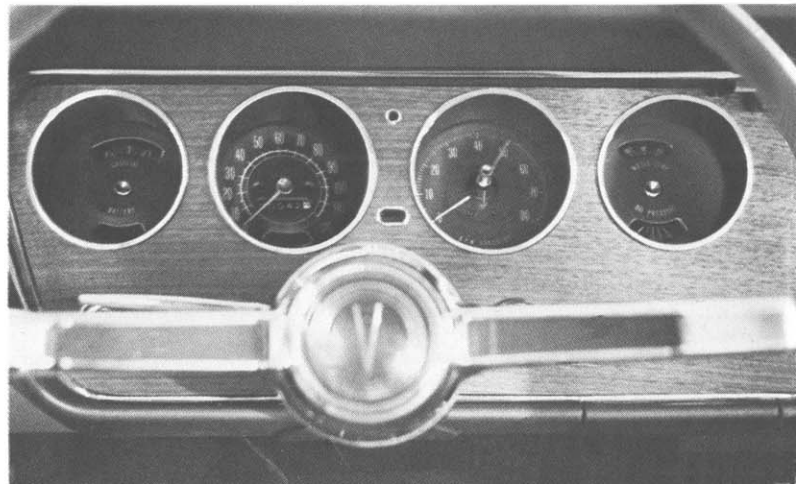

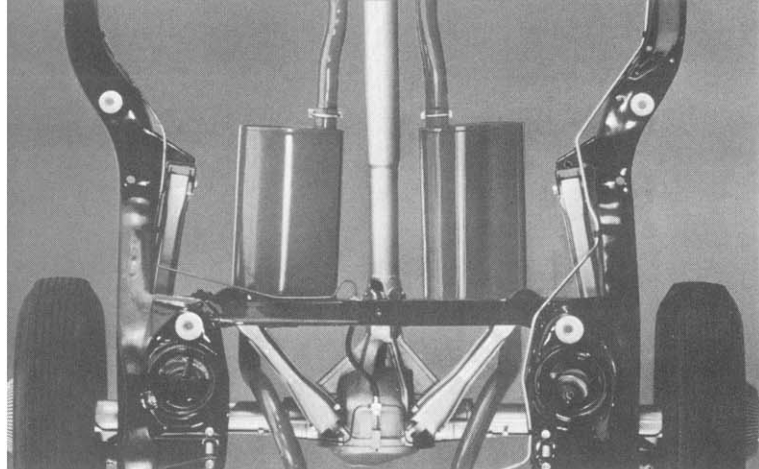

**F. Dual Exhausts ▲ G. Superlift Shock Absorbers ▼**

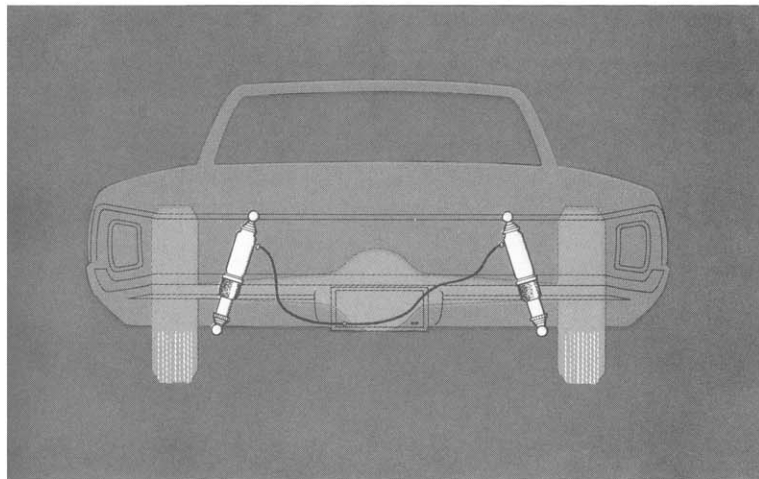

**H. Full Transistor Ignition System ▼**



**I. Full Transistor Voltage Regulator ▼**

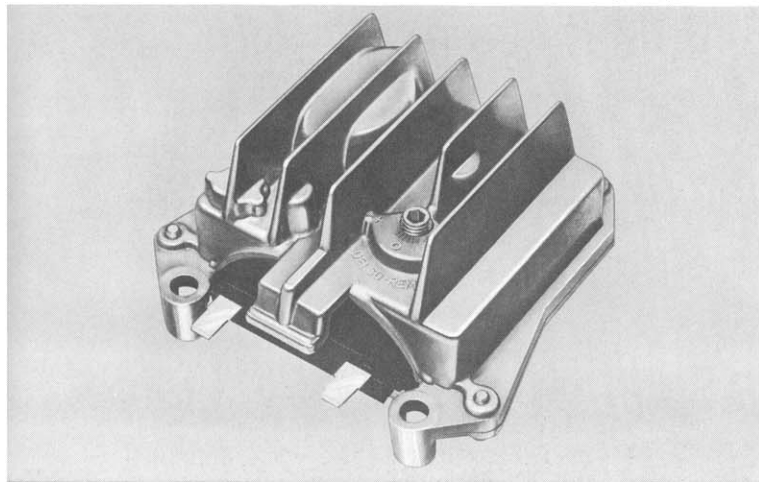

**TEMPEST  
TEMPEST CUSTOM  
LE MANS • GTO**

**A. Safe-T-Track Differential (Code 731)**

Power is directed from one driving wheel to the other, always the one with the best grip on the road surface. Controlled ride through rutted roads on sand or gravel, over bumps or chuckholes, through heavy snow, on wet or icy roads. Minimizes the hazard of getting stuck. (F)

**B. Custom Sports Steering Wheel (Code 471)**

Handsome wood-grain appearance. Has three equally spaced brushed stainless steel spokes. Horn button is in center. (F)

**C. Exhaust Tailpipe Extensions (Code 482)**

Two gleaming extension pipes for dual exhaust system; one extension pipe for OHC L-6 4-bbl engine. (F,D)

**D. Rally Clock (Code 444)**

Features sweep second hand and special built-in automatic self-regulator. Illuminated dial for easy night reading. Not available with Rally Cluster option (Code 448). (F,D)

**E. Rally Cluster (Code 448)**

Includes 250° sweep tachometer, speedometer, oil pressure and water temperature gauges—plus fuel indicator and battery tell-tale light. Tachometer not available without Cluster (F). Rally Clock (Code 444) not available with Rally Cluster.

**F. Dual Exhausts (Code 481)**

Cuts down back pressure in exhaust systems, adds to engine efficiency. Available on 326 V-8 regular fuel engine. Standard on GTO models and with 326 HO engine. (F)

**G. Superlift Shock Absorbers, Rear (Code 634)**

Help maintain level ride when trunk or trailer-tongue loads are extra heavy. Adjustable air spring is built into shock absorber. Equipped with tire-type air-filler for simple air fill at service stations. (F,D)

**H. Full Transistor Ignition System (Code 671)**

The finest of ignition systems. Provides ignition without condenser or mechanical contacts. Combines increased high-speed output with greater ignition stability, is rugged and water-proof. Available as option for premium fuel engines only. (F)

**I. Full Transistor Voltage Regulator (Code 664)**

Increases battery life, provides voltage regulation. No moving parts or breaker points. (F)





A. Tilt Steering Wheel ▲

B. Deluxe Steering Wheel ▼

C. Full-width Floor Mat (Front Only) ▼

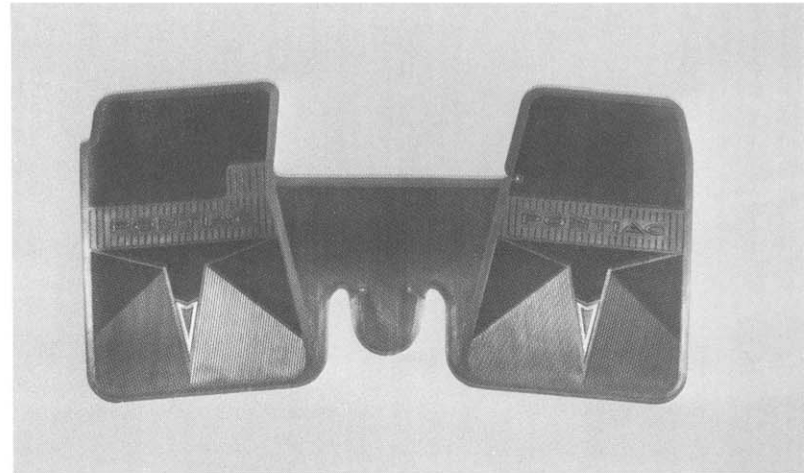
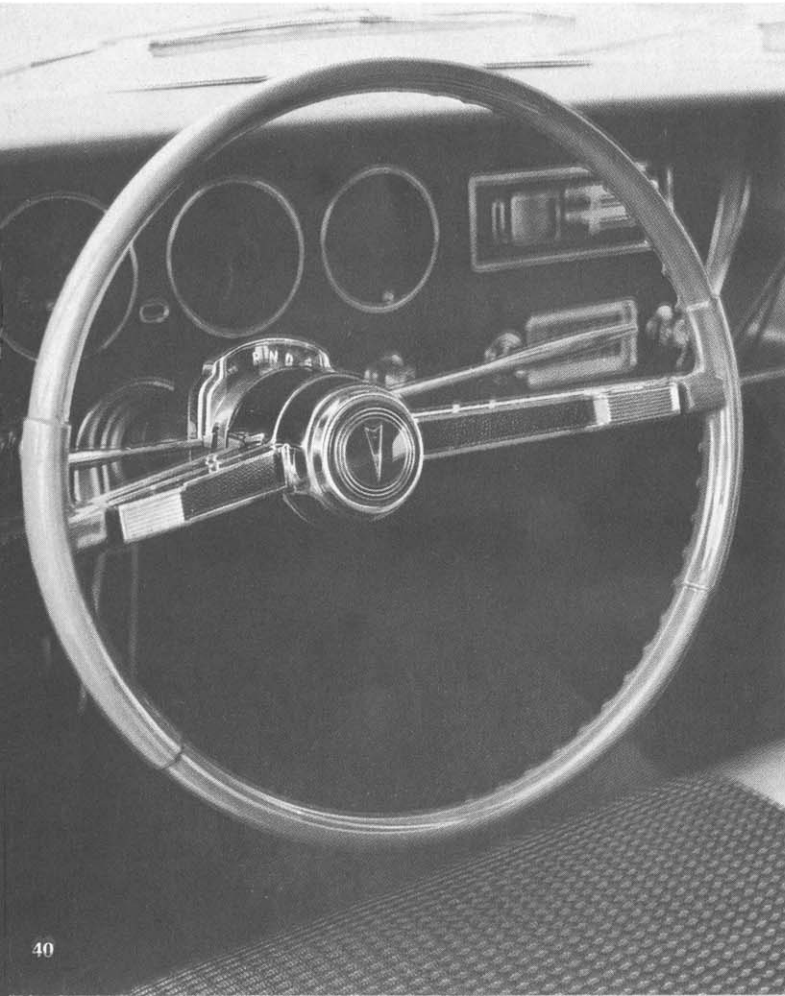

D. Floor Mats, Front and Rear ▼

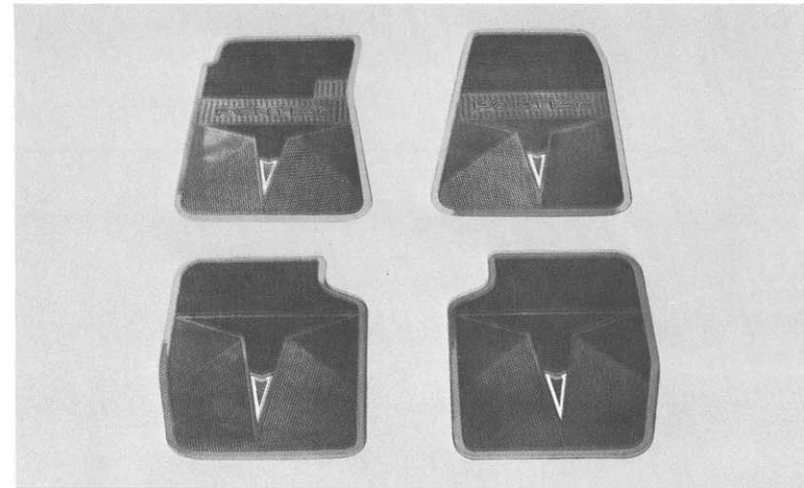

TEMPEST  
TEMPEST CUSTOM  
LE MANS • GTO

---

**A. Tilt Steering Wheel (Code 504)**

Easily adjusts to 7 different positions to meet individual physical requirements. Increases steering comfort, permits easier entry or exit from car. Provides improved over-the-wheel vision. Available with Power Steering only. (N.A. with 3-speed column shift.) (F)

**B. Deluxe Steering Wheel (Code 462)**

Horn activator bars are recessed into each of the two wheel spokes. Included in Decor Group on Tempest, standard on Tempest Custom, Le Mans and GTO Series. (F)

**C. Full-width Floor Mat (Front Only)**

Extends over center hump, easily removed for cleaning. Attractively styled in 8 colors that complement interiors. (D)

**D. Floor Mats, Front (Code 631) Rear (Code 632)**

Keeps car looking new. Durable and practical. Easily removed for washing. Available in 8 Pontiac colors to harmonize with the interiors. (F,D)

**E. Door Edge Guard (Code 382)**

Bright, stainless steel strips help prevent nicks and scratches on door edges. (F,D)

**F. Cushion Topper**

Added comfort for front seat. Sleek rayon with foam backing available in 5 colors to match interiors. (D)

**G. Car Compass**

Dependable, with special compensator for car use. Illuminated dial. (D)

**H. Dual Horns (Code 494)**

Emit a loud, commanding sound. Optional on Tempest, standard on all others. (F)

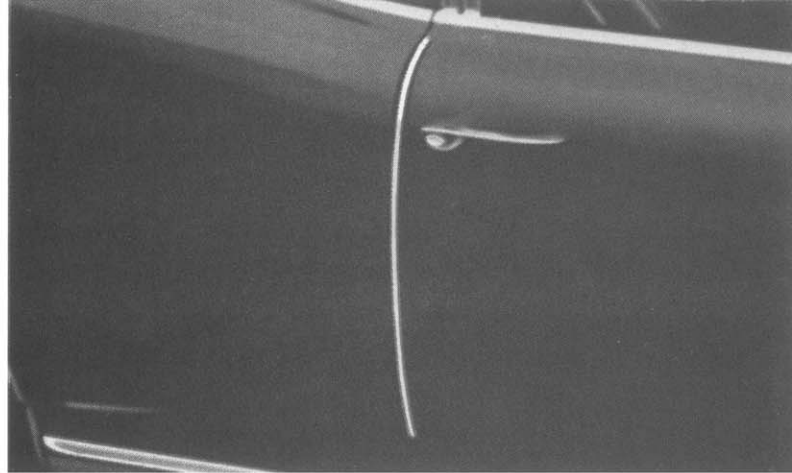

E. Door Edge Guard ▲

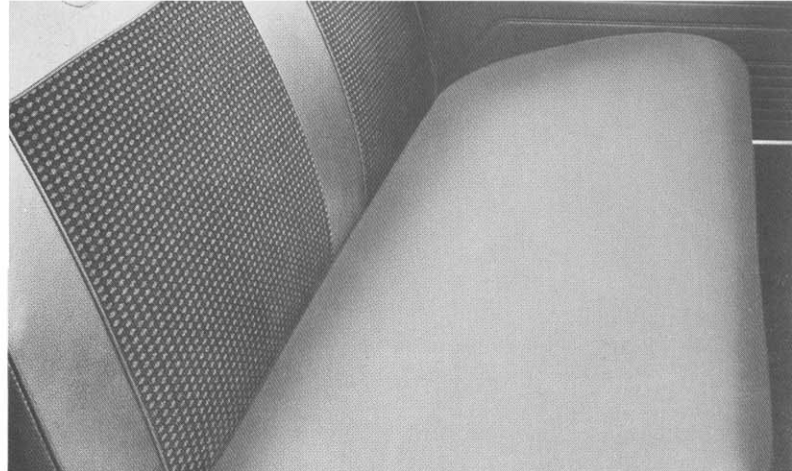

F. Cushion Topper ▲



G. Car Compass ▲ H. Dual Horns ▼

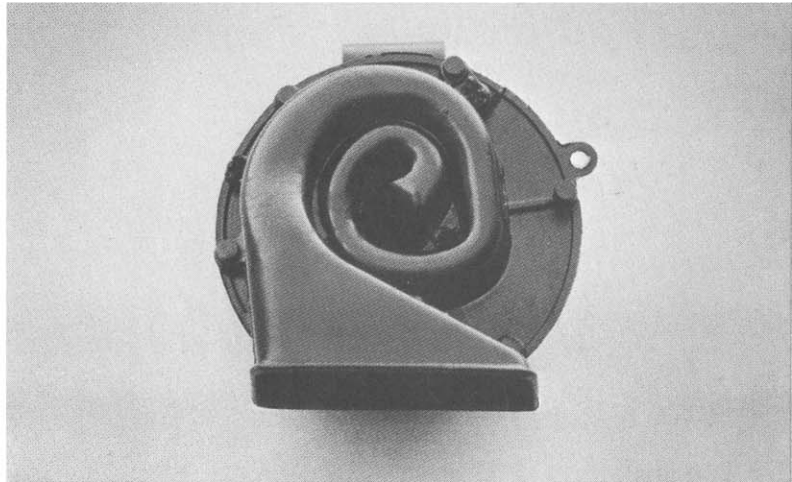

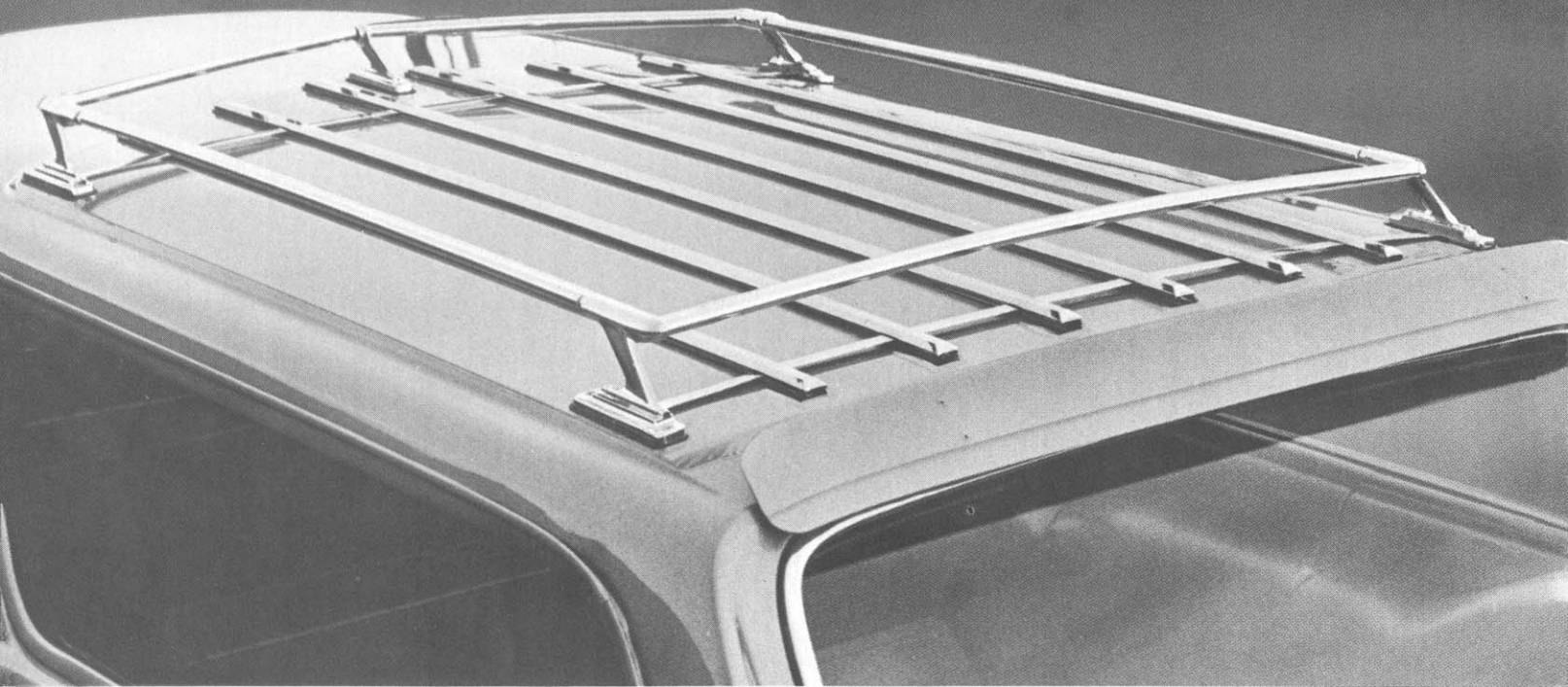

A. Chrome Luggage Carrier ▲

B. Luggage Carrier Cover—Rakpak ▼

C. Removable Luggage Carrier—Karpak ▼

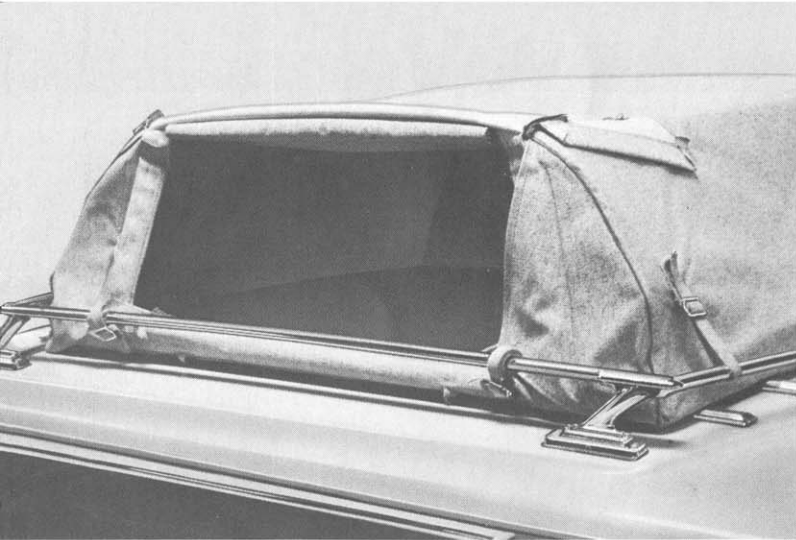

D. Removable Ski Carrier Adapter ▼

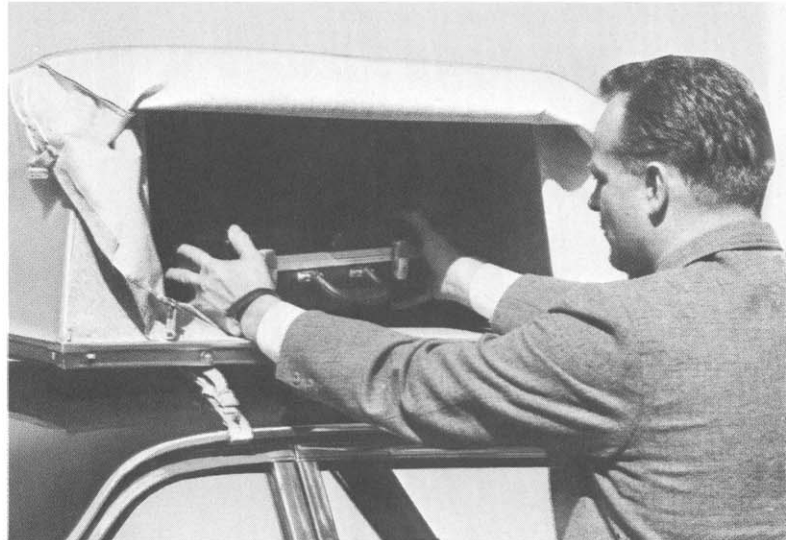

E. Utility Pad ▼

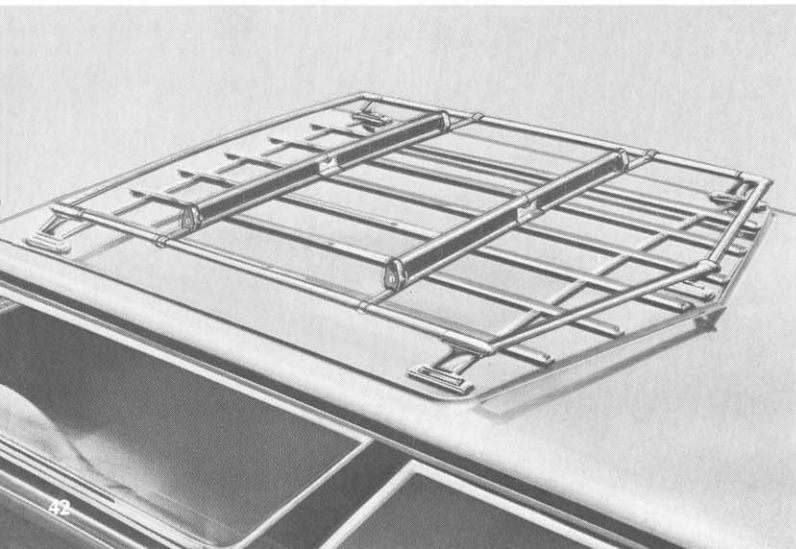

**TEMPEST  
TEMPEST CUSTOM  
STATION WAGONS**

---

**A. Chrome Luggage Carrier (Code 512)**

Handsome, sturdy. Carries plenty of luggage allowing extra passenger space inside. Side rails provide tie-down. Permanently installed on Station Wagons. (F,D)

**B. Luggage Carrier Cover—Rakpak**

Water and dust-resistant fabric protects luggage. Side opening can be locked. Cover folds flat when not in use. For Station Wagon Luggage Rack. (D)

**C. Removable Luggage Carrier—Karpak**

Lightweight, easily removed, quickly installed on roof or deck lid. All models except Station Wagons with luggage carrier. (D)

**D. Removable Ski Carrier Adapter**

Attaches easily to Station Wagon luggage carrier. Carries up to six pairs of skis. Has key lock for protection against ski theft. (D)

**E. Utility Pad**

Ideal for children. Constructed of durable, vinyl-coated fabric. Available in two-tone combinations of gray and aqua, mahogany and green, and yellow and red. (D)

**F. Power Tailgate Window (Code 542)**

Conveniently located switch raises or lowers tailgate window with touch of the finger . . . makes it easier to open tailgate. (F)

**G. Station Wagon Rear Window Deflector (Code 378)**

Horizontal metal vane directs airstream down on to rear window; helps keep it free of dust. Also promotes quieter ventilation of interior when cowl vents are open, side windows closed and rear window open. (D,F)

**H. Tailgate Window Screen**

Lets you keep the tailgate window open, screens out bugs. Made of fine reinforced mesh. Held in place by raising window part way. (D)

**I. Rear Door Window Screens**

Great for campers, children or pets. Attaches permanently to inner rear door window frame. Windows may be raised or lowered without removing screen. (D)

**J. Gas Cap Lock (Station Wagon Only)**

Prevents fuel theft. Separate key. (D)



**F. Power Tailgate Window ▲ G. Station Wagon Rear Window Deflector ▲**

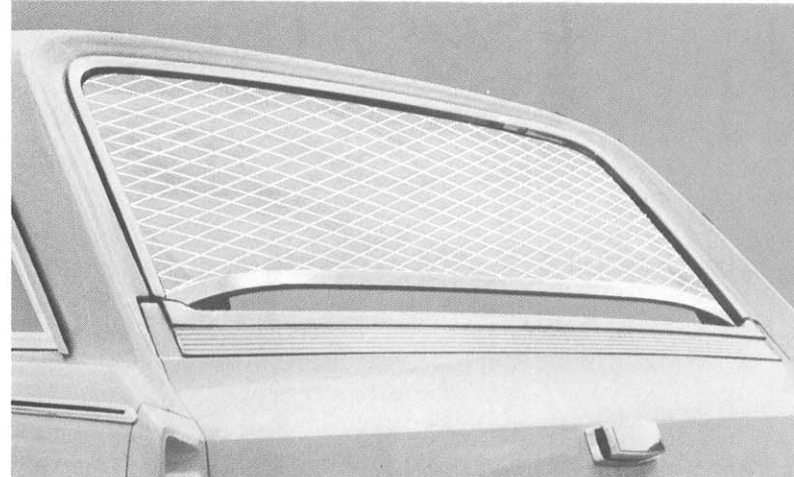

**H. Tailgate Window Screen ▲ I. Rear Door Window Screens ▼**



**J. Gas Cap Lock (Station Wagon Only) ▼**

**A. Custom Wheel Discs (Code 458)**

Made of chrome-flashed stainless steel with handsomely slotted cooling vents. (F,D)

**B. Wire Wheel Discs (Code 452)**

For the special flair and sport car look. Gleaming wire spokes handsomely styled and structurally strong. (F,D)

**C. Rally Wheels (Code 454)**

With 7.75 x 14 tires only. Functional and sporty. Large openings provide maximum cooling for brakes. Includes stainless steel cap, chrome-plated wheel nuts and stainless steel full trim ring. (F)

**D. Deluxe Wheel Discs (Code 461)**

Chrome-flashed stainless steel ribs, outer rim and center hub with 10 deep-set cooling vent openings edged in black on a dull-gray background. (F,D)



A. Custom Wheel Discs ▲

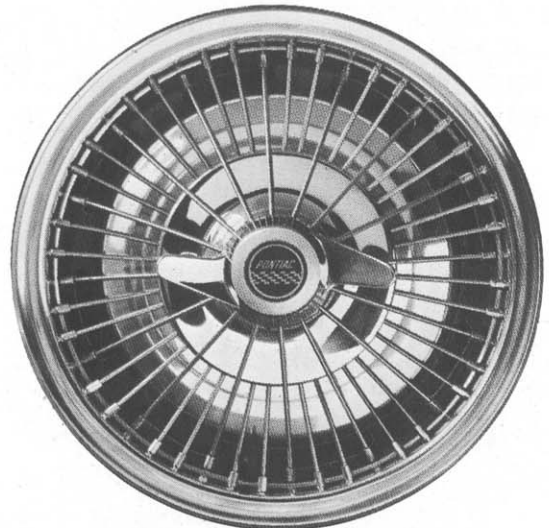

B. Wire Wheel Discs ▲



C. Rally Wheels ▲



D. Deluxe Wheel Discs ▲

**E. Console with 3-Speed or 4-Speed Manual Transmission (Code 472)**

Available on Le Mans (except 4-door Hardtop) and GTO Series. Available only with bucket seats. Finished in stylish, ribbed metal. On both 3- and 4-speed transmissions, the shift knob features a shifting diagram. (F)

**F. Console with Automatic Transmission (Code 472)**

Available only on Le Mans and GTO models equipped with bucket seats. Finished in stylish, ribbed metal. (F)

**G. Gearshift Knob (Code 524)**

Walnut gearshift knob for GTO Series only with 4-speed synchromesh. (F,D)

**H. Headrest (Code 571)**

Extra protection and comfort. Bolster is covered in handsome, long-wearing Morrokide in complementary colors to the interiors. (F)

**I. Reclining Bucket Seat (Code 574)**

Reclines at 45° angle, allows passengers to stretch out and relax. Headrests (Code 571) are included for both passenger and driver's side with Reclining Bucket Seats. (F)

**Custom Carpet (Code 572)**

Loop pile nylon blend carpet. Handsome and long-wearing. Optional at extra cost on Tempest, standard on Tempest Custom, Le Mans and GTO. (F,D) (Not illustrated)

**E. Console with 3-Speed or 4-Speed Manual Transmission ▼**

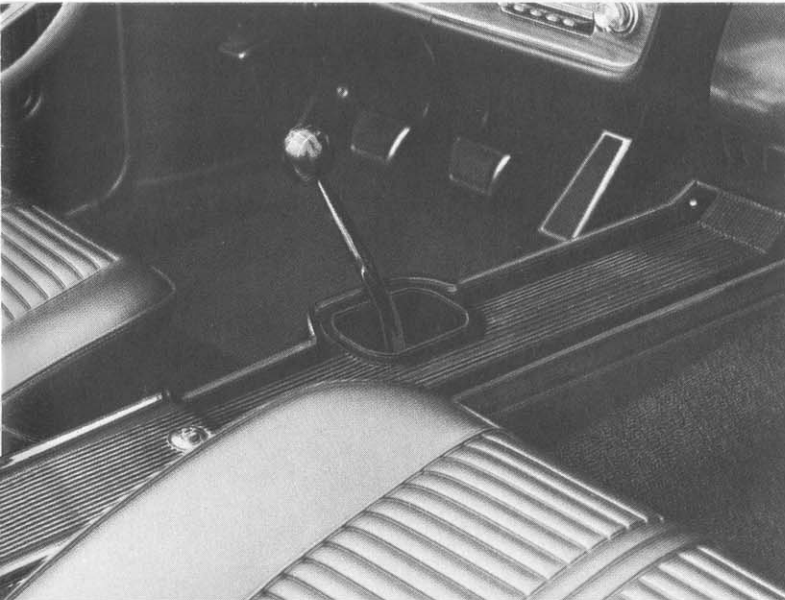

**F. Console with Automatic Transmission ▼**

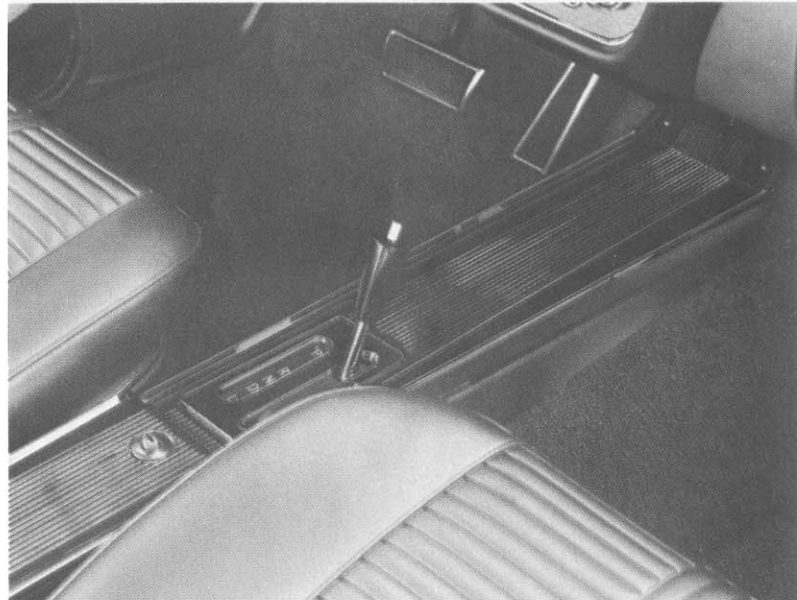

**G. Gearshift Knob ▼ H. Head Rest ▼**

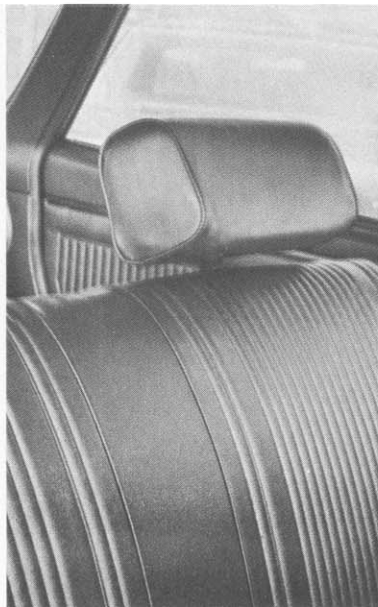
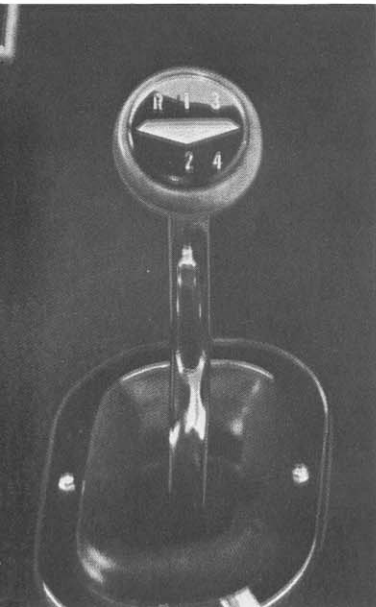

**I. Reclining Bucket Seat ▼**

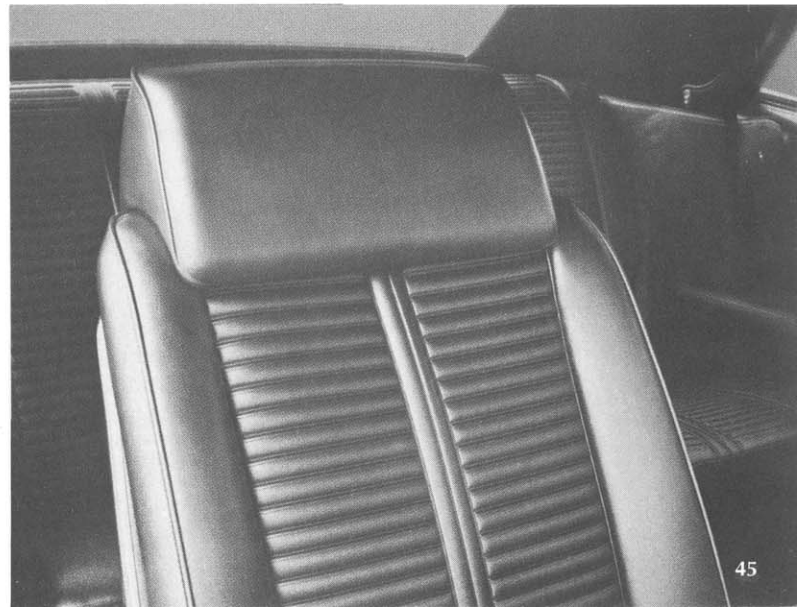



**Pontiac Motor Division / General Motors Corporation**

Pontiac Motor Division of General Motors Corporation reserves the right to make changes at any time, without notice, in prices, colors, materials, equipment, specifications and models, and also to discontinue models.