



GREATER
TRACTION
WHATEVER
THE
WEATHER

....WITH PONTIAC SAFE-T-TRACK
(LIMITED-SLIP DIFFERENTIAL)

THE LIMITED SLIP DIFFERENTIAL POWER WHERE IT'S

As in *any* differential, engine power is transmitted through the ring gear (A) to the differential case (B). In the *limited slip differential*, this driving force causes the cross pins (C) to move up the cam surfaces (D) forcing the disc clutches (E) into engagement.

Engagement of both clutches in effect “locks” the axle shafts (F) in normal straight-ahead driving. If traction is unequal, the *limited slip differential* automatically proportions the usable torque with the greater force being applied to the wheel with the most traction.

When cornering, however, the action of the faster turning outside wheel overcomes the clutch load so that the operation is, in effect, that of a conventional differential.

**YOU DON'T SPIN YOUR WHEELS WITH
A LIMITED SLIP DIFFERENTIAL**

**BECAUSE POWER GOES TO THE WHEEL
WITH THE GREATER TRACTION**

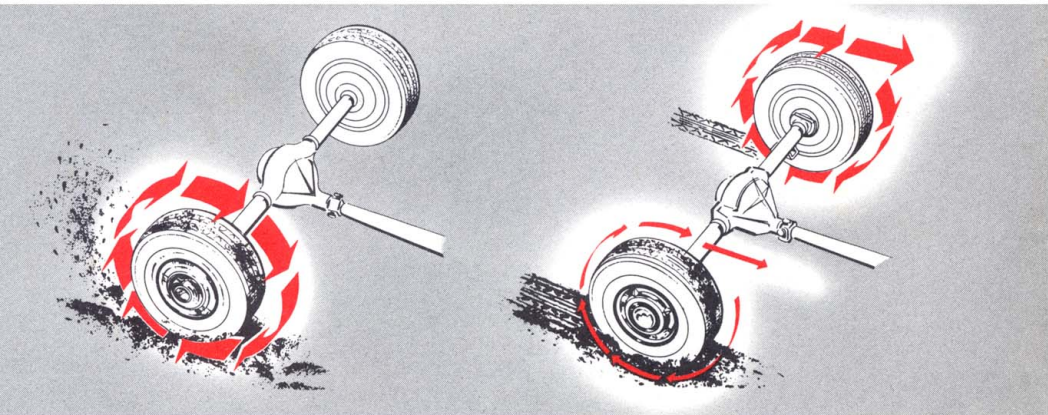

CONVENTIONAL DIFFERENTIAL...

wheel on slick surface spins. Other wheel is useless. Car can't move.

LIMITED SLIP DIFFERENTIAL...

wheel on slick surface does *not* spin. Other wheel takes over and pulls car out of trouble.

AUTOMATICALLY DELIVERS NEEDED

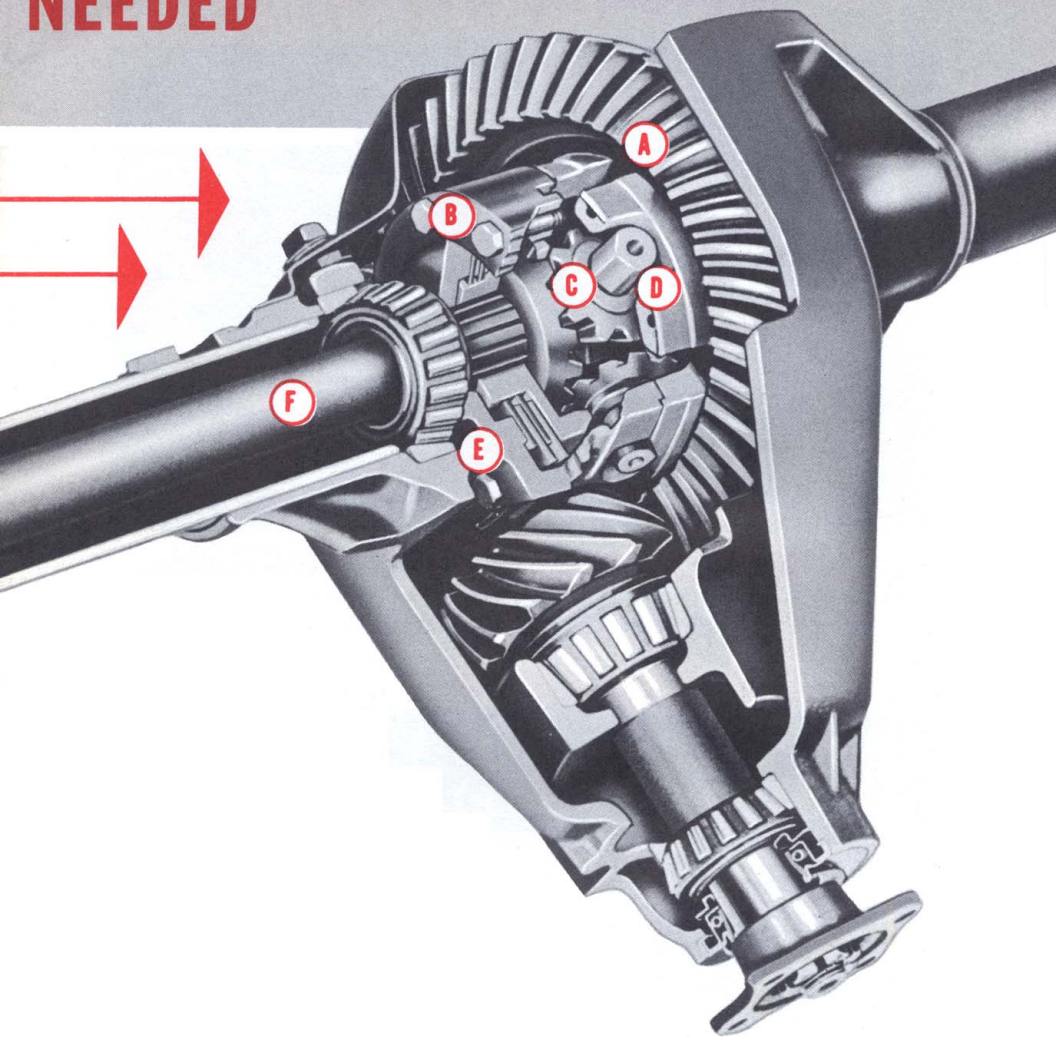

A limited slip differential protects you from getting stuck . . . in mud, sand, snow or ice. You step on the gas and you go—so long as either rear wheel has traction.

SPRING—SUMMER—FALL—WINTER . . . GETS YOU OUT OF TROUBLE . . .



YOU GO THROUGH MUDDY ROADS . . . you pull through wet, deeply rutted roads without bogging down, because smooth, steady power shifts from one rear driving wheel to the other . . . always the one with the best grip.

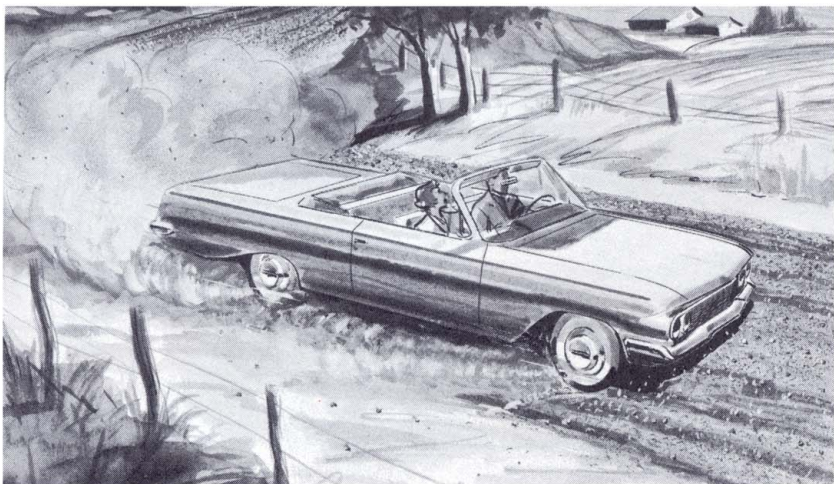

YOU GO THROUGH SAND and GRAVEL . . . prevent “wheel-hop” and spinning wheels on rough roads with bumps and chuckholes. End a source of dangerous car swerve and tire scuffing.

. A LIMITED SLIP DIFFERENTIAL . KEEPS YOU OUT OF TROUBLE

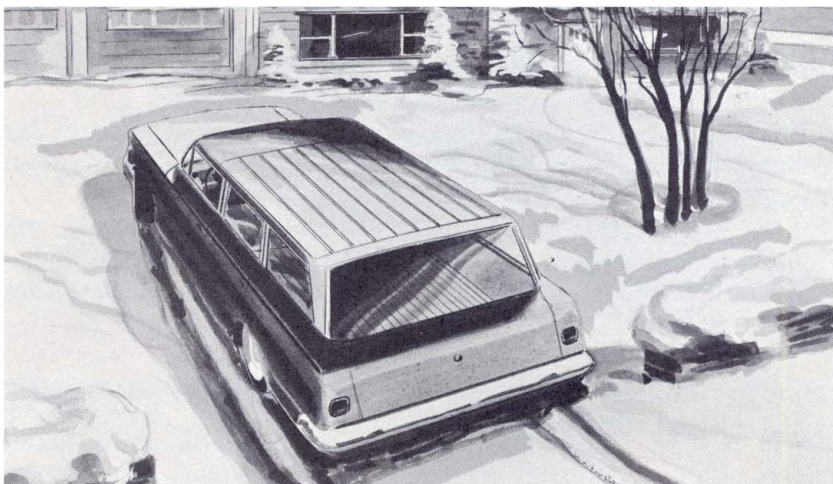

YOU GO THROUGH HEAVY SNOW . . . pull away from curbs covered with deep, packed snow. Keep safe and moving when one wheel goes off the road, because power shifts to the wheel with best traction.

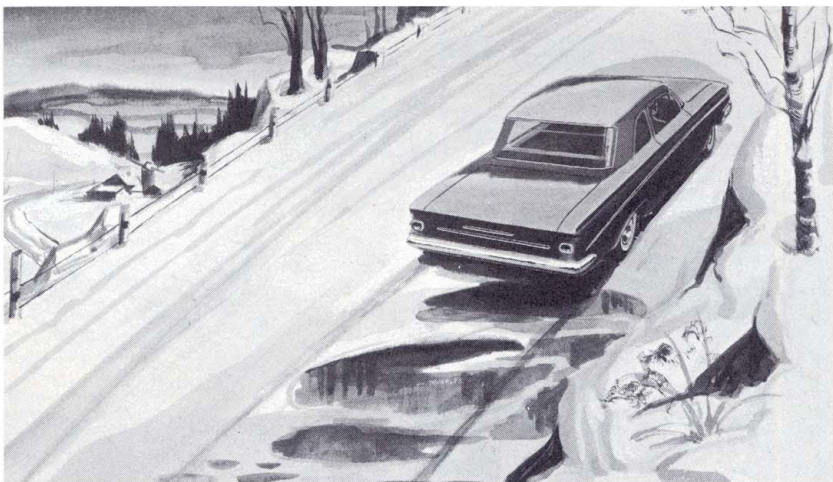

YOU GO ON SLICK and ICY ROADS . . . helps climb slippery hills—with less risk of skidding out of control. Avoid dangerous spinning wheels because power goes to the wheel with the best grip.

FEW PEOPLE CAN AFFORD TO GET STUCK OR STRANDED

Today's motorist *depends* on his automobile (or truck) to get him *where* he wants to go . . . *when* he wants to get there.

Plans and appointments are made . . . emergencies arise . . . and people and goods *must* move from one place to the other . . . every day of the year, in all kinds of weather.

Like the automatic transmission, and power steering, the limited slip differential has become a vital and necessary option—especially for people engaged in “special” occupations and activities.

Here are some of the people who have a very definite “need” for a limited slip differential.

FARMERS frequently drive through mud, sand, snow and ice—with both family car and light truck. Time is money for farmers. A limited slip differential saves both.



MAIL CARRIERS

drive on every kind of road in all weather—have one rear wheel on the shoulder much of the time. A limited slip differential is as important as brakes for many mail carriers.

DOCTORS

must “get through” on emergency calls. They just can’t afford to get delayed. A limited slip differential can help save lives—perhaps your own.

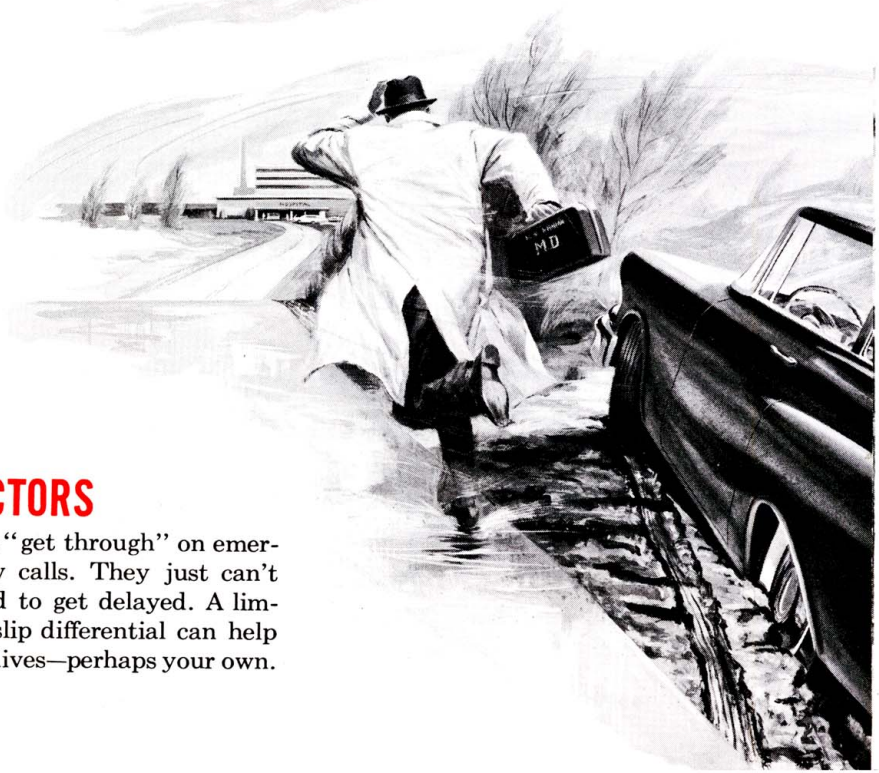
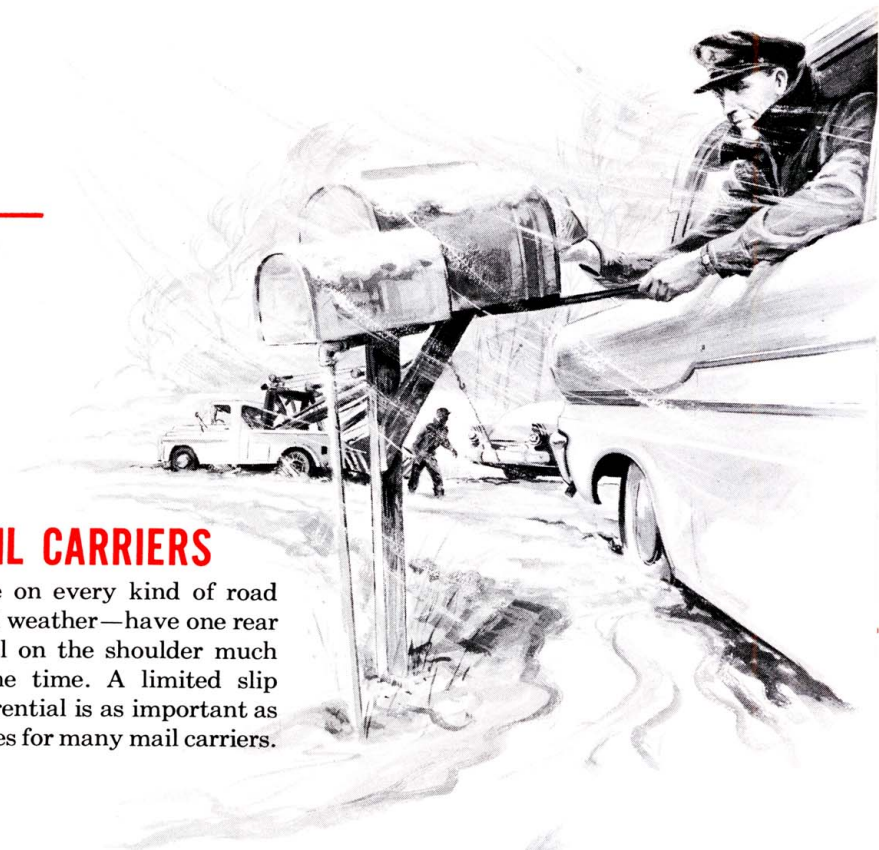



SALESMEN can lose orders by arriving late for appointments. Muddy and icy roads are common barriers, but a limited slip differential will help save time—and orders.



BOATERS pull boat trailers with heavy loads through sand and mud. A limited slip differential spells convenience—increases vacation pleasure.

HUNTERS travel over trails, lanes and ruts—in the most remote regions. A limited slip differential means convenience under conditions such as these.

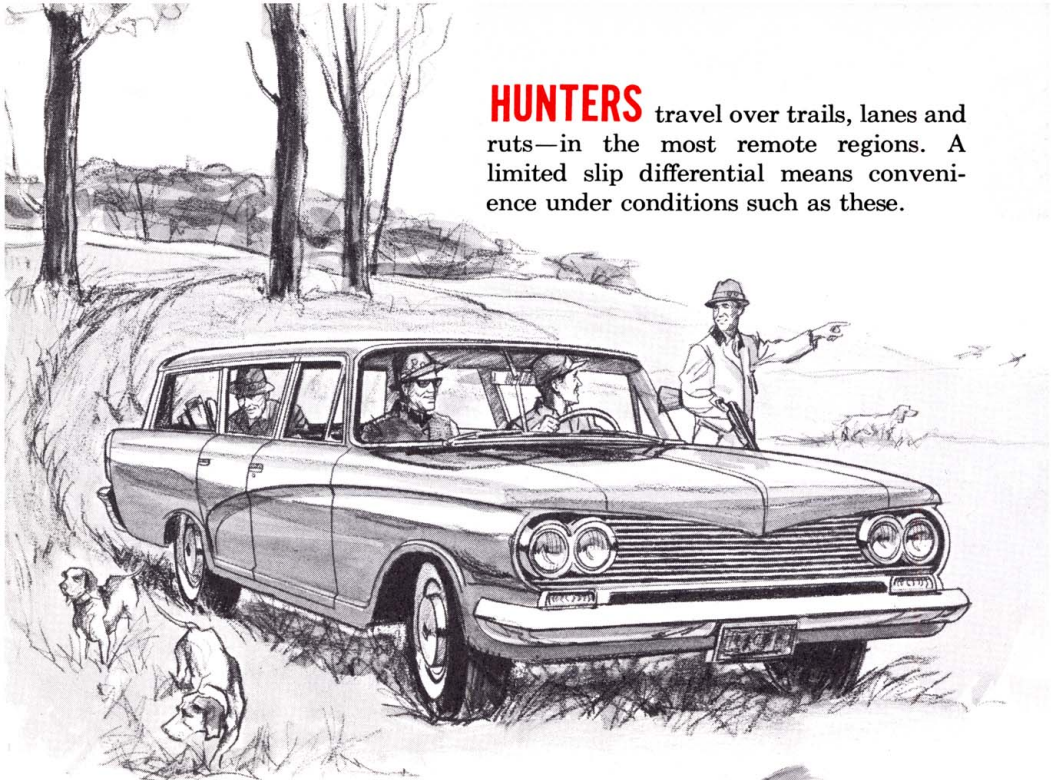

WOMEN

“chauffeur” the children to school, and to many other activities. They need the assurance their “precious cargo” won’t be stranded. A limited slip differential means *peace of mind* to many woman drivers.



CONTRACTORS operate cars and light trucks on job sites that always seem to be muddy. Limited slip differentials cut downtime—cut operational costs.



UTILITY cars and light trucks must operate day and night regardless of weather and road conditions. A limited slip differential can get the crew “through” to do the job.



POLICE must “get to the scene” faster and more often than anyone. A limited slip differential may be the means to save those extra few minutes.

Almost everyone needs a Limited Slip Differential

- **TAXI DRIVERS** need limited slip differentials to keep meters clicking when business is best, during bad weather.
- **DELIVERY MEN** keep on schedule and make more “stops” in bad weather—with limited slip differentials.
- **FLEET OWNERS** need limited slip differentials to keep their men productive—and valuable merchandise on the move.
- **PERFORMANCE ENTHUSIASTS** need limited slip differentials for extra traction, increased stability, and greater acceleration at the track and drag strips.

Drive With Greater Confidence . . .

ASK FOR SAFE-T-TRACK WHEN YOU ORDER YOUR NEW PONTIAC!

"The Wheel That's Got the Traction Gets the Action!"

- Safe-T-Track assures a better grip on the road—regardless of surface conditions. Safe-T-Track automatically applies usable power to the wheel with the most traction. You GO as long as EITHER WHEEL has traction!
- Safe-T-Track could actually save you money—by avoiding costly tow-truck calls, snow tires and chains. Modestly priced, Safe-T-Track can pay for itself by eliminating even a few emergency situations.
- Safe-T-Track is well proved—over a million car owners are enjoying the peace-of-mind benefits of a Limited-Slip Differential. Every year, many letters are received from owners, praising the wonderful convenience of "Limited-Slip."
- Safe-T-Track sells itself with one demonstration. Try it on snow, ice, sand, gravel, mud. (It even improves traction and cornering on dry pavement!) Experience the new driving confidence it can give you, then let us include Safe-T-Track on your order for a new Pontiac. It's available factory-installed on all Pontiac models.

THE SAFE-T-TRACK DIFFERENTIAL IS MANUFACTURED TO PONTIAC'S RIGID ENGINEERING SPECIFICATIONS BY...



DANA

CORPORATION

Toledo, Ohio