

Buick 1939

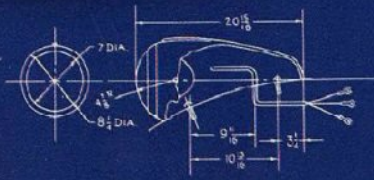

Styleblazer for 1939

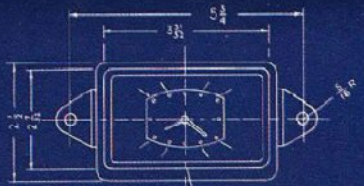
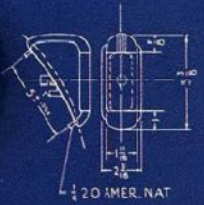
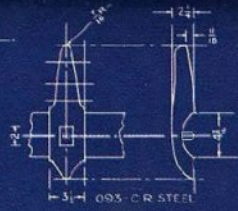
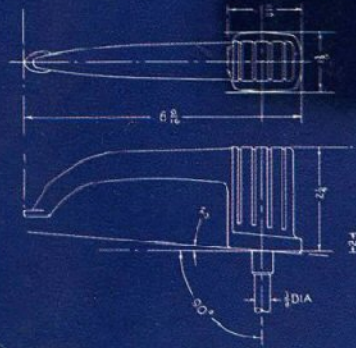
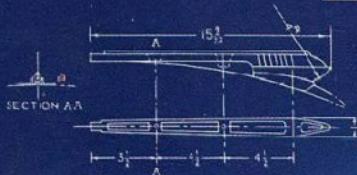

INTRODUCTION TO A BEAUTY



It started with the "catwalk-cooling" on the costly, built-to-order racing cars of Europe.



Buick engineers were shooting at better aerodynamics, not new styling—but what they touched off will repattern cars everywhere before it's through.

What it means in fresh loveliness of line and form you will quickly see on the pages that follow.

What matters more is that Buick is not merely the beauty in appearance, but in every aspect of fine car performance!

So let your eyes take it in—all the lithe grace and sweep of it. See the lean chaste purity of its pattern, the look of action singing out of every line.

But spot the *meaning* behind these vital changes!

Not only the smart styling in the placing of radiator grilles—but the eminent good sense in placing them where air-pressure's greatest!

Not only the light and airy look of its deeper-windowed upper-structure—but the vastly bettered visibility that this extra glass provides!

Not alone the sure and solid "set" of this car, but the stable roadability of its Bui-coil cushioned wheels—not alone the fleetness in its line but the stirring action at your command in its great, eight-cylindrical Dynaflex engine!

Go deeper, if you please!

Look into the Buick-beauty underneath all this, in the good true metals, the split-hair precision, the tough alloys.



Look into the prideful craftsmanship that's lavished on every part and step of construction; this Buick's built solidly on the firm-rooted faith of craftsmen in the car they build—and their stout insistence that only the best work is good enough for Buick!

Of new features to be found in the 1939 Buick—of its spaciousness and comfort and convenience and good taste—the following pages will tell you plenty.

But for the firm, taut feel of it under your hand—for its keen and eager willingness under your treadle-foot's suggestion—for its tuned and poised staunchness in face of the toughest jobs—you must go deeper than the printed page.

You must take this great car out on the road, and there let it tell for itself why, on *every* count, Buick's the beauty of the 1939 season!



SPACIOUSNESS WITH SPIRIT!

It is not quite enough to say that the Buick Limited and the Buick Roadmaster are built for people whose need is for a big car. They are built for those who want spaciousness—*and* spirited performance as well!

The size of these cars is illustrated by their wheelbase—140 inches for the Limited, 133 inches for the Roadmaster. Roadweight and interior roominess correspond with these basic dimensions.

Yet the Roadmaster accelerates from 10 to 60 miles per hour in eighteen seconds flat, the Limited in three-tenths of a second more. Each will top an 11% hill at better than forty from a ten-mile start.

Even such statistics fail to prepare you fully for what you experience when you drive the car itself. Steering is unbelievably light. Parking presents no problem. The densest traffic is mastered with amazing ease.

And with such brilliance of performance—a brilliance which has created a definite place for Buick in the large car field—goes luxury of appointment and fitting difficult to duplicate within hundreds of dollars of the price.

The Limited

MODEL 90

A spacious eight-passenger four-door touring sedan with trunk back. Extra seats, illustrated in the sketch, fold flush with floor and front-seat back when not in use.

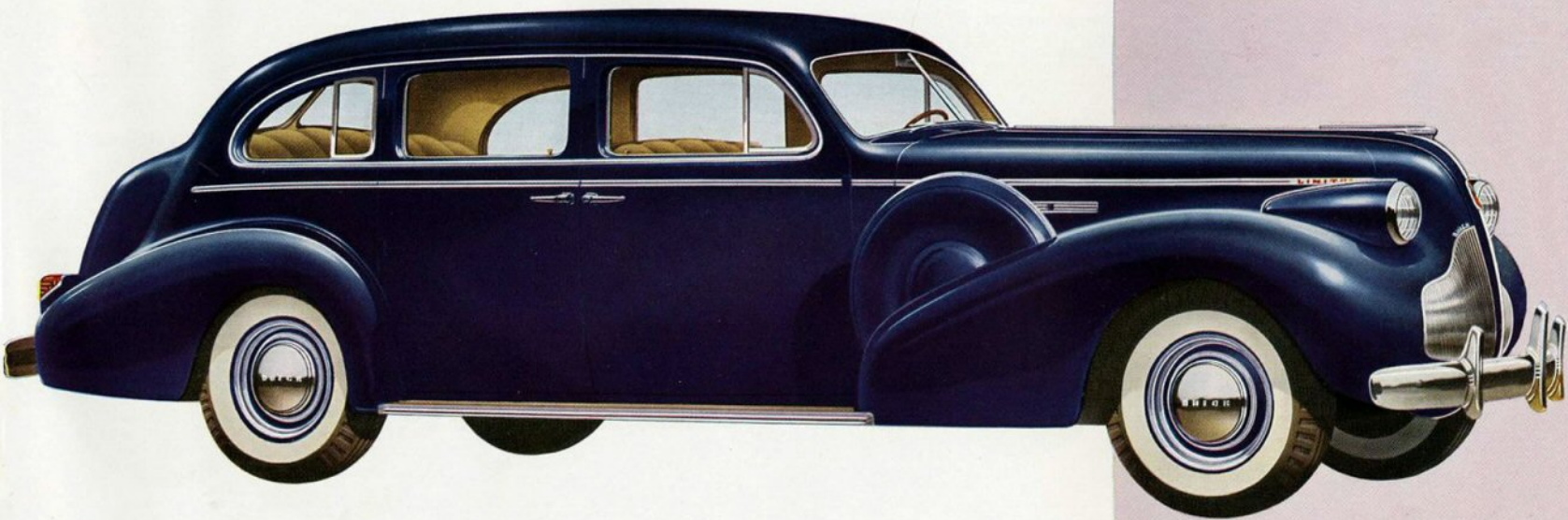

WHEELBASE: 140 INCHES • ENGINE: 141 HORSEPOWER DYNAFLASH VALVE-IN-HEAD STRAIGHT-EIGHT

The Limited

MODEL 91

A six-passenger four-door touring sedan with trunk back. A roomy compartment is built into the back of the front seat as illustrated in the sketch.

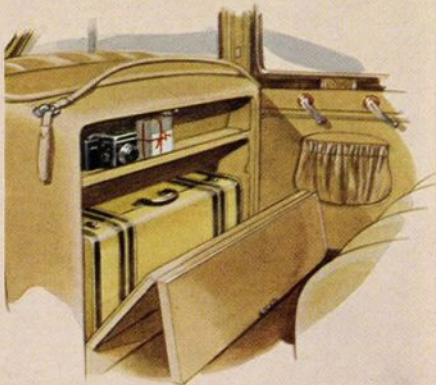

WHEELBASE: 140 INCHES • ENGINE: 141 HORSEPOWER DYNAFLASH VALVE-IN-HEAD STRAIGHT-EIGHT

The Limited

MODEL 90-L

An eight-passenger limousine with trunk back, equipped with speaking phone to driver. The glass partition behind chauffeur's seat is adjustable.

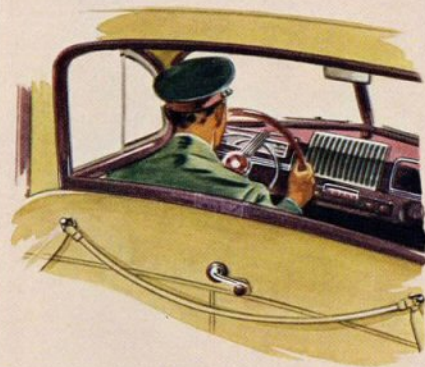

WHEELBASE: 140 INCHES • ENGINE: 141 HORSEPOWER DYNAFLASH VALVE-IN-HEAD STRAIGHT-EIGHT

This typical sedan interior illustrates the roomy spaciousness of these great Buicks and the smartness of their interior trim. A wide choice of upholstery materials enables you to express your individual taste to perfection. Materials available include fine quality Bedford Cord and Broadcloth. Leather in varying combinations is available on the Roadmaster convertible phaetons.



One rear arm-rest carries an ash receptacle and lighter—the other this convenient vanity and notebook.



A broad center arm-rest drops down from the rear seat-back in sedan models. Eight inches wide, this arm-rest provides ample elbow-room for two at the same time.



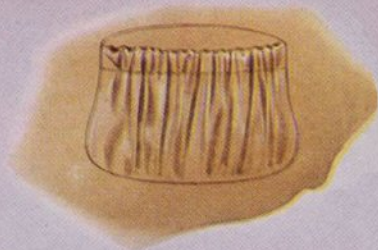
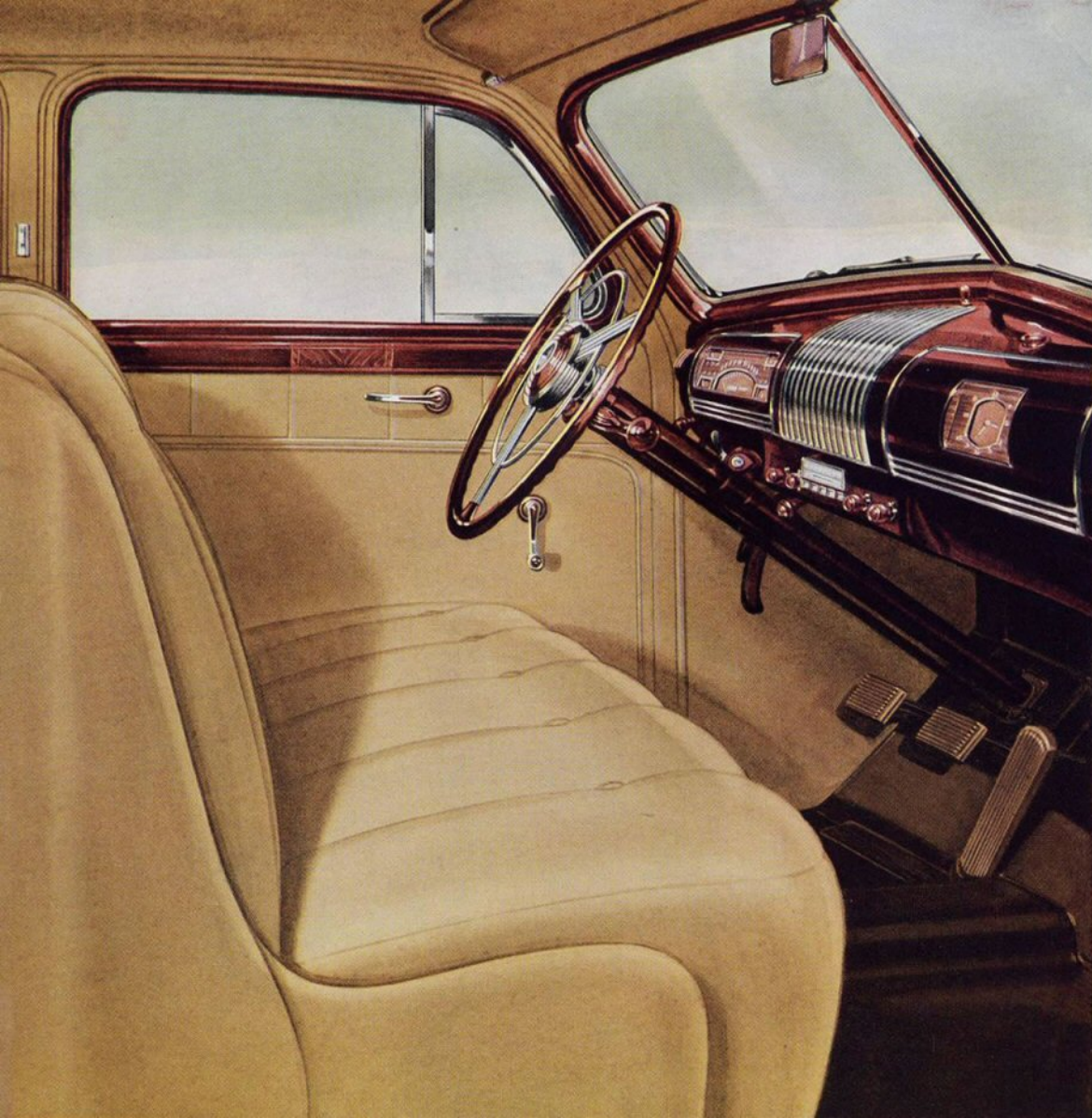

Rear doors in sedan models carry a capacious pocket, attractively shirred. An ideal place for carrying road maps, magazines, and small parcels.



All Limited and Roadmaster models have spacious built-in luggage compartments, with capacities up to 26 cubic feet. These compartments are automatically lighted when the trunk lid is raised.

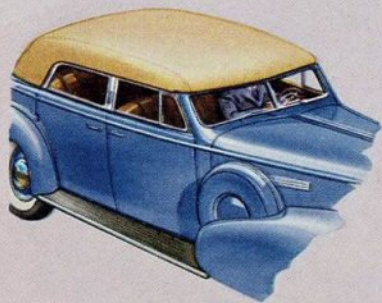

The Roadmaster

MODEL 81-C

This six-passenger four-door sport phaeton has a trunk back. The sketch shows the trim appearance of the car with the top up.

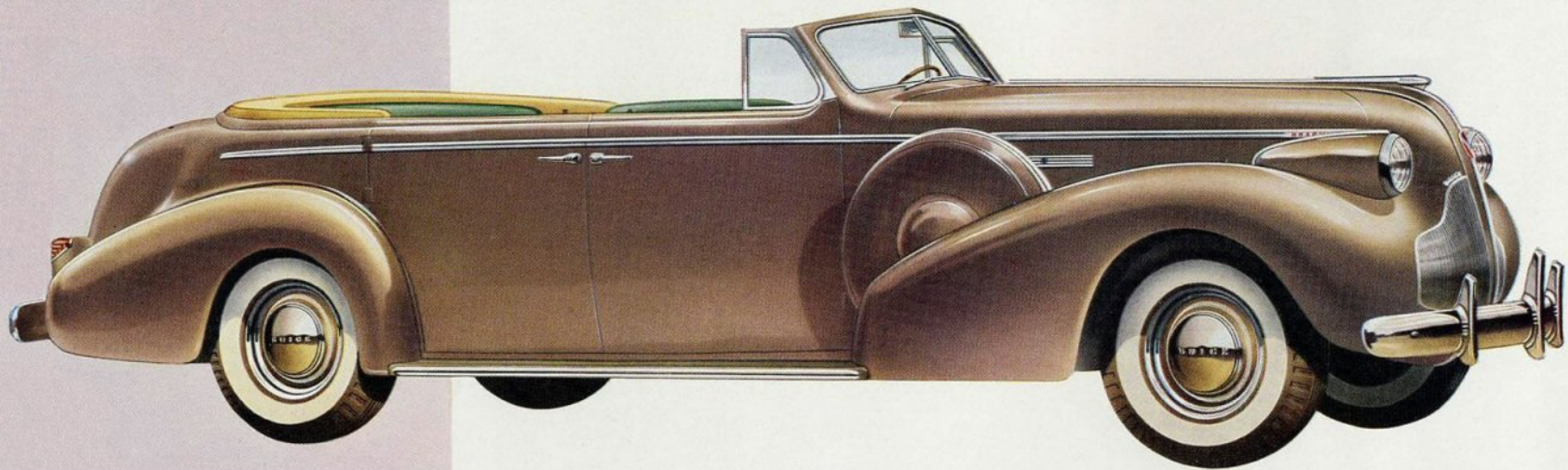

WHEELBASE: 133 INCHES • ENGINE: 141 HORSEPOWER DYNAFLASH VALVE-IN-HEAD STRAIGHT-EIGHT

The Roadmaster

MODEL 31

A six-passenger four-door touring sedan with trunk back. The sketch illustrates the tasteful interior trim and the broad arm-rest provided at each side.

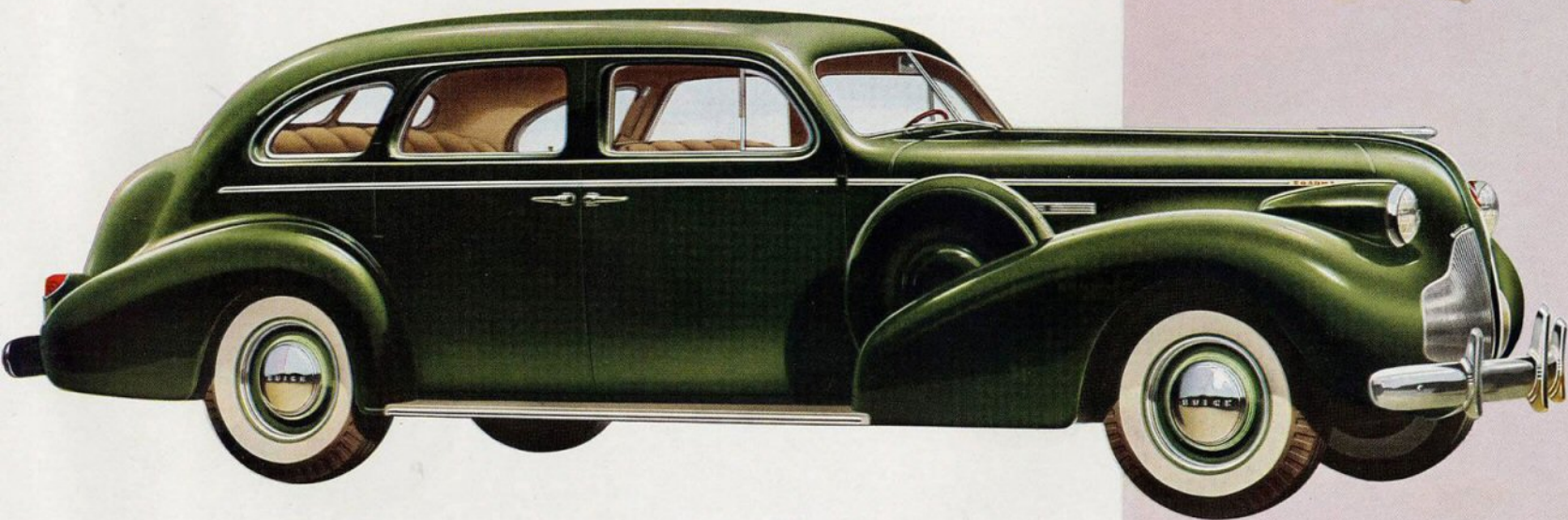

WHEELBASE: 133 INCHES • ENGINE: 141 HORSEPOWER DYNAFLASH VALVE-IN-HEAD STRAIGHT-EIGHT

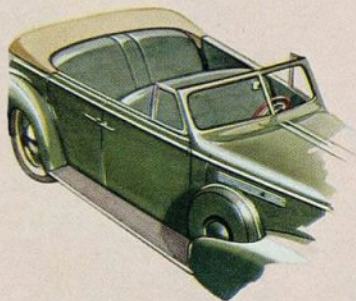

The Roadmaster

MODEL 80-C

This six-passenger convertible streamline sport phaeton is available on special order only. The top folds down neatly as shown in the sketch.

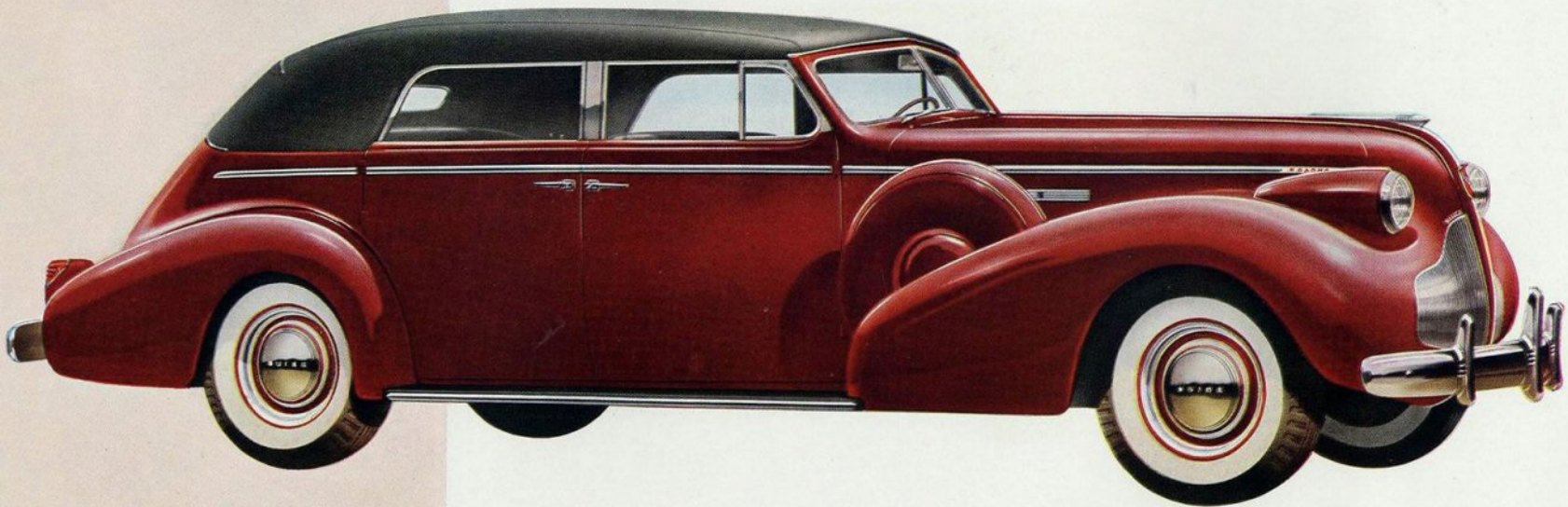

WHEELBASE: 133 INCHES • ENGINE: 141 HORSEPOWER DYNAFLASH VALVE-IN-HEAD STRAIGHT-EIGHT

The Roadmaster

MODEL 81-F

This six-passenger four-door formal sedan has adjustable glass partition in the back of the front seat which may be raised to shut off driver's compartment.

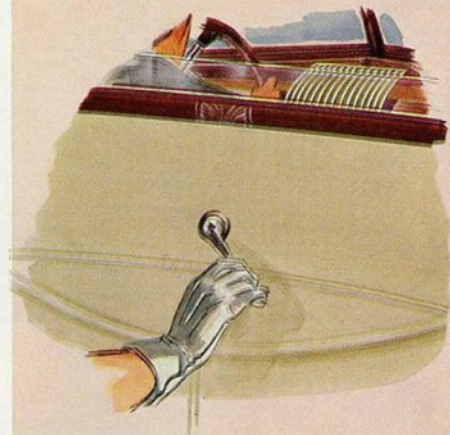
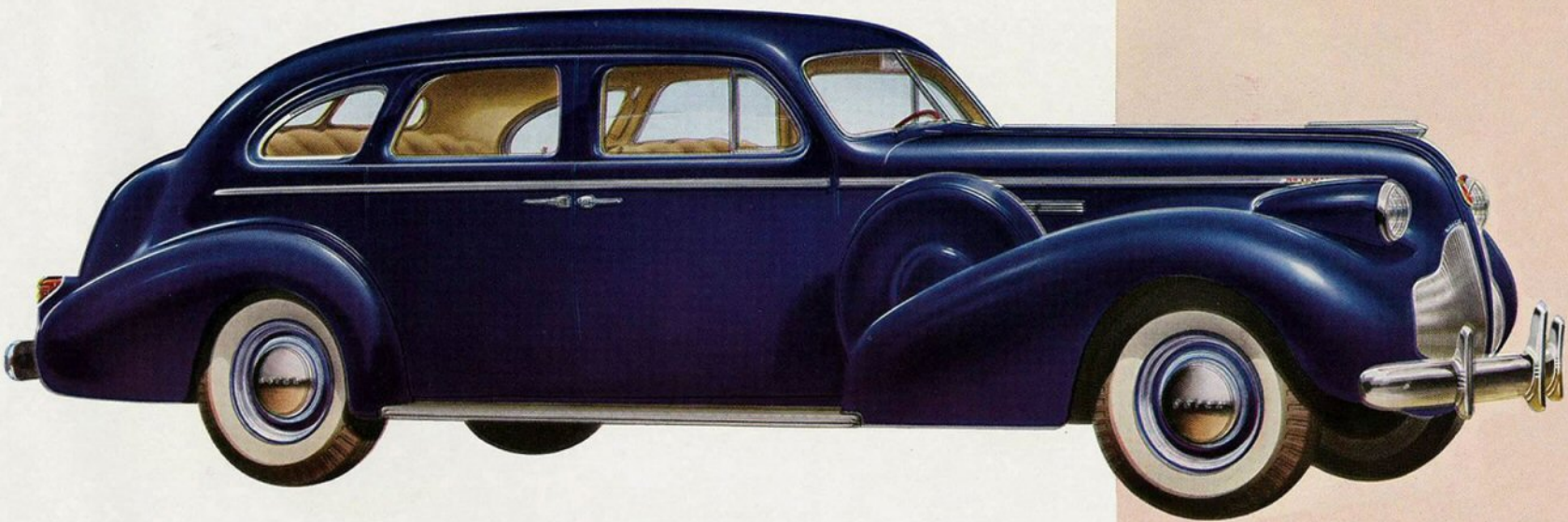

WHEELBASE: 133 INCHES • ENGINE: 141 HORSEPOWER DYNAFLASH VALVE-IN-HEAD STRAIGHT-EIGHT

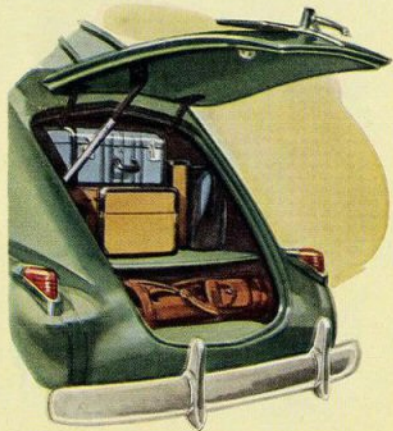

The Roadmaster

MODEL 87

This six-passenger four-door sedan with plain back is available on special order only. Lighted luggage compartment has ample capacity as shown in the sketch.

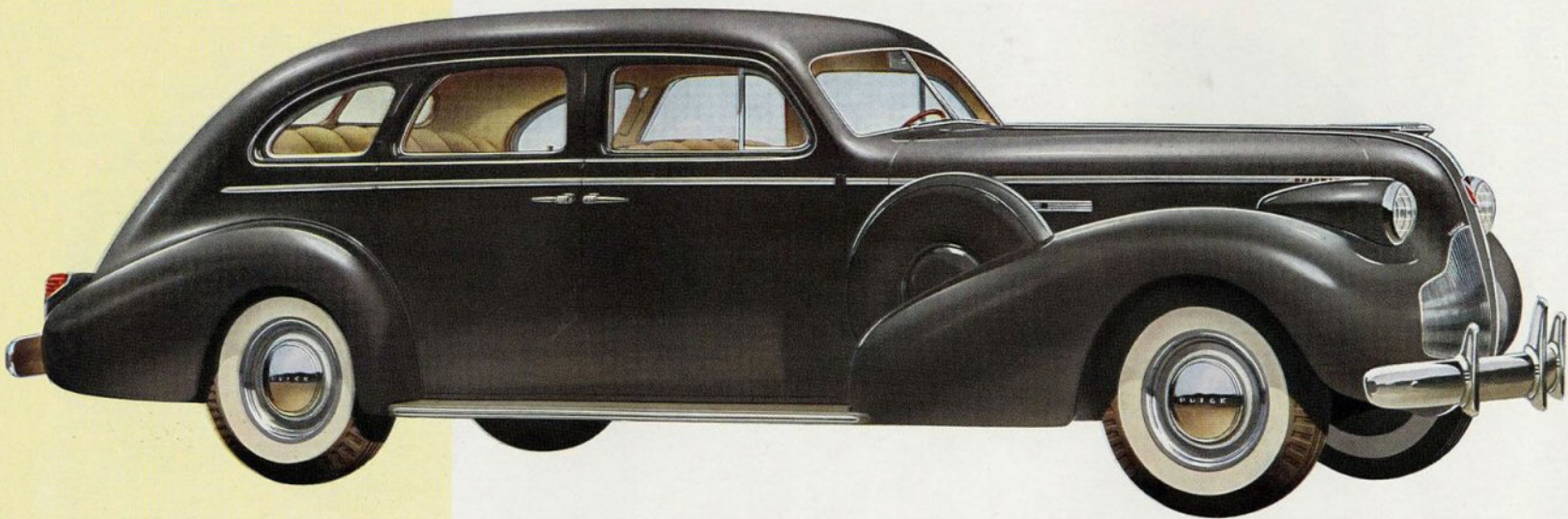

WHEELBASE: 133 INCHES • ENGINE: 141 HORSEPOWER DYNAFLASH VALVE-IN-HEAD STRAIGHT-EIGHT



GOOD COMPANIONS

Only one quality comes down the Buick assembly line, hence any distinction drawn between series is purely a distinction of size, capacity, and fitness to your need.

Liveliest of all the Buicks is the Century, smaller than the Roadmaster and Limited, but powered with the same, mighty 141-horsepower Dynaflex Valve-in-Head Straight-Eight Engine.

It can flash you from ten to sixty in a trifle more than sixteen flashing seconds. Its top speed is far in excess of anything you will ever need.

And for that very reason it travels tirelessly, smoothly, easily. Its capacity is so great it has always something in reserve.

Similar in dimensions is the Buick Special. Its wheelbase is shorter and its Dynaflex engine develops a maximum of 107 horsepower.

And it, too, is mightily able at speed or on hills. No driver will ever have normal occasion to strain it to its utmost.

Wherever either of these great cars goes, the thrill of swift and easy travel goes as well.

They're "life of the party" when the program calls for a frolic—they're steady, stable, reliable companions when the business in hand is the serious business of getting there unfailingly.

For both of these cars are true-blue Buicks, to be bought confidently, owned proudly, driven with deeply satisfying pleasure.

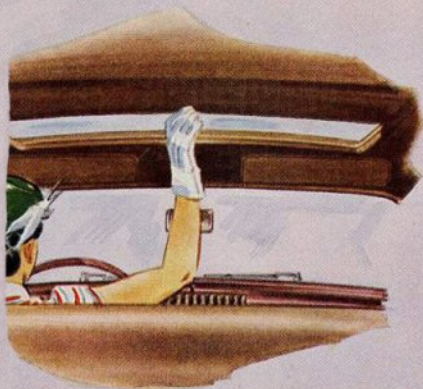

The Century

MODEL 61

A five-passenger four-door sedan with trunk back. Available with drip-proof, rain-proof sliding "Sunshine Turret Top" at extra cost.

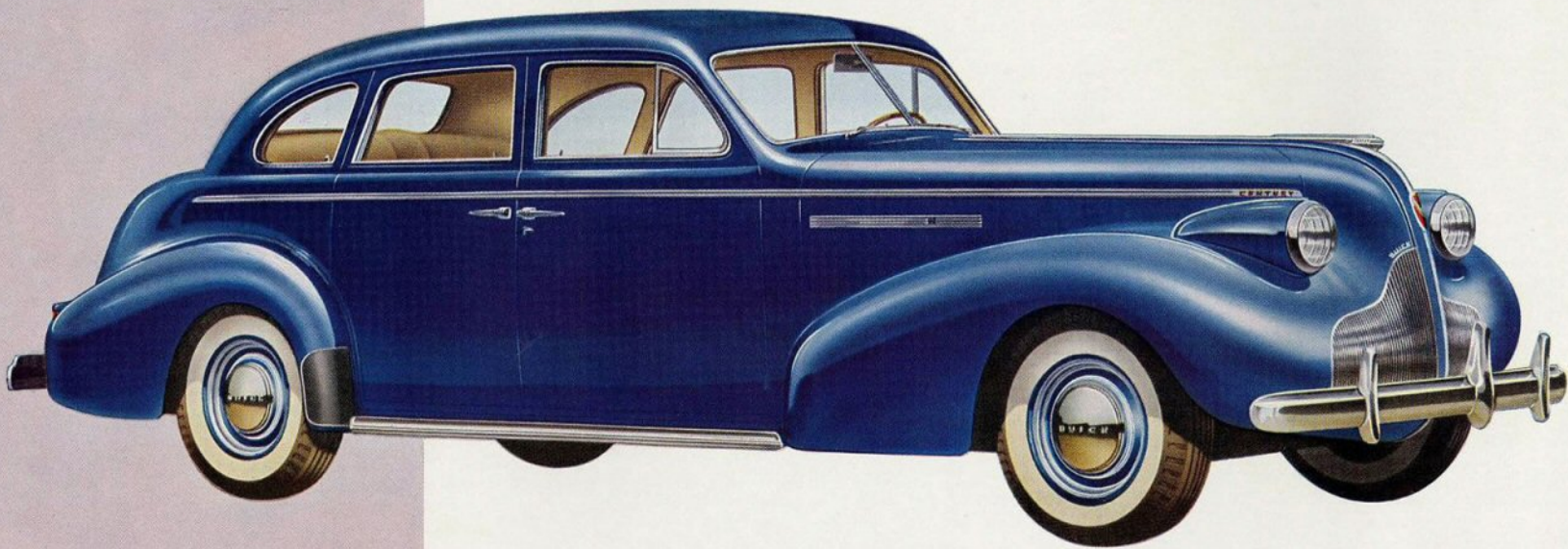

WHEELBASE: 126 INCHES • ENGINE: 141 HORSEPOWER DYNAFLASH VALVE-IN-HEAD STRAIGHT-EIGHT • CHOICE OF STREAMBOARDS (SHOWN) OR RUNNING BOARDS

The Century

MODEL 66-C

With two opera seats behind the driver's seat, this convertible coupe carries four passengers, all fully protected against the weather.

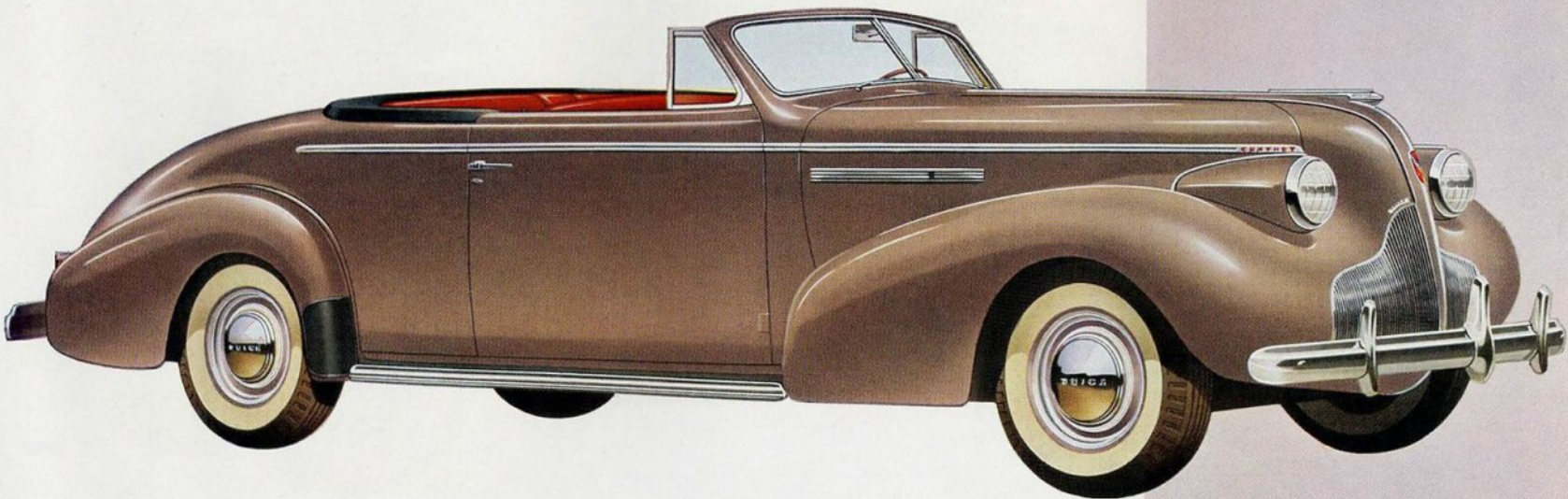

WHEELBASE: 126 INCHES • ENGINE: 141 HORSEPOWER DYNAFLASH VALVE-IN-HEAD STRAIGHT-EIGHT • CHOICE OF STREAMBOARDS (SHOWN) OR RUNNING BOARDS

The Century

MODEL 66-S

A four-passenger sport coupe with folding opera seats. Note the hardware, richly decorated with inlaid plastic.

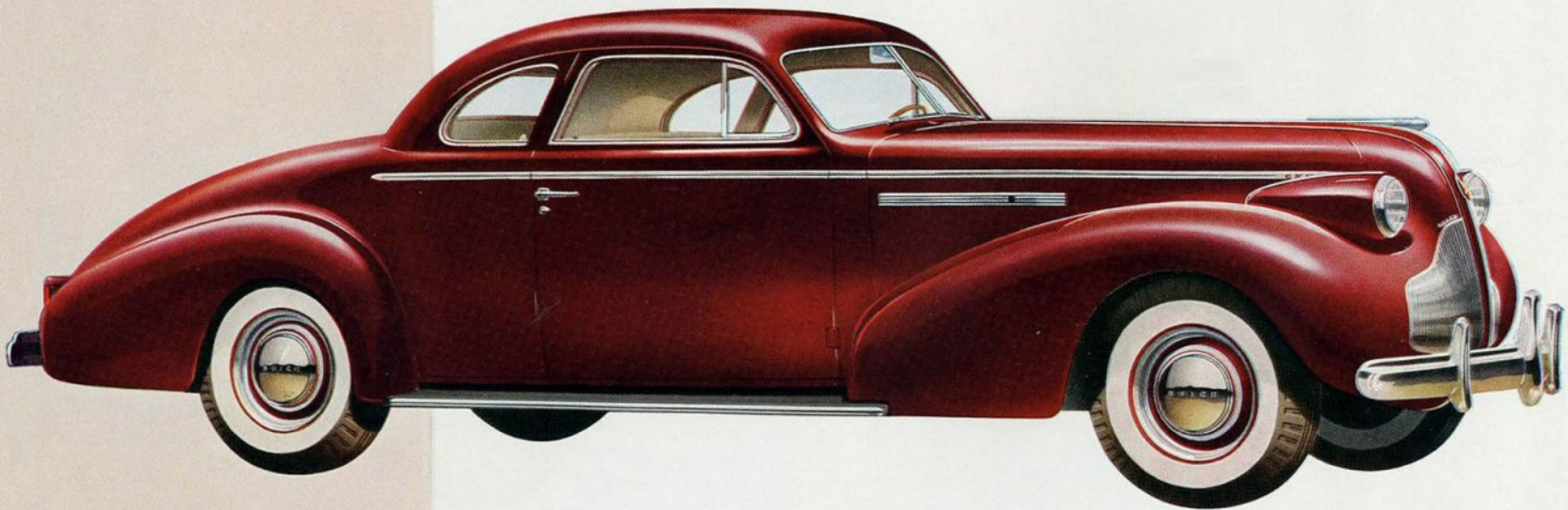
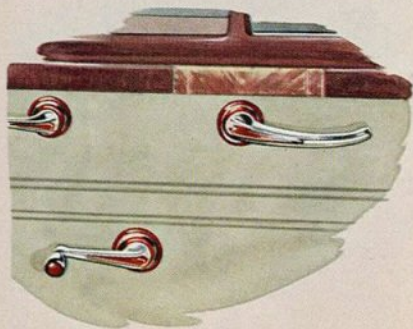

WHEELBASE: 126 INCHES • ENGINE: 141 HORSEPOWER DYNAFLASH VALVE-IN-HEAD STRAIGHT-EIGHT • CHOICE OF STREAMBOARDS OR RUNNING BOARDS (SHOWN)

The Century

MODEL 61-C

A five-passenger four-door sport phaeton with trunk back. Notice the convenient new location of front seat adjustment control on all models.

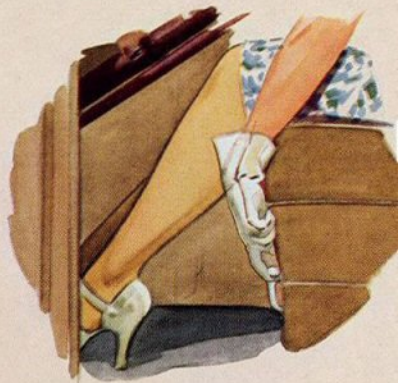

WHEELBASE: 126 INCHES • ENGINE: 141 HORSEPOWER DYNAFLASH VALVE-IN-HEAD STRAIGHT-EIGHT • CHOICE OF STREAMBOARDS (SHOWN) OR RUNNING BOARDS



This four-door sedan interior is representative of the tasteful finish of all Century models. Hardware is smartly designed with colorful plastic inlays. Sedans and coupes are upholstered in taupe novelty cloth. Convertible models are upholstered in tan Bedford cloth, leather or combined cloth and leather at no extra cost.

A special radio, providing touch tuning for five of your favorite stations, has been designed for the 1939 Buick. Offered as an accessory, it is available on all models. Note that the rear floor is virtually "tunnel free."

The Special

MODEL 41

A five-passenger four-door touring sedan with trunk back. Sliding "Sunshine TurretTop" as illustrated in sketch, is available at extra cost.

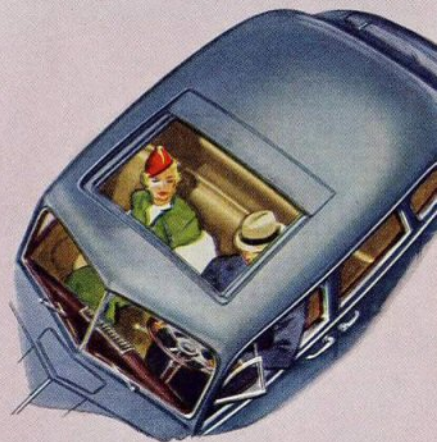

WHEELBASE: 120 INCHES • ENGINE: 107 HORSEPOWER DYNAFLASH VALVE-IN-HEAD STRAIGHT-EIGHT • CHOICE OF STREAMBOARDS (SHOWN) OR RUNNING BOARDS

The Special

MODEL 46

This two-passenger business coupe is specially designed for commercial use. The sketch shows the specially designed fender lamp available on all models as an accessory.



WHEELBASE: 120 INCHES • ENGINE: 107 HORSEPOWER DYNAFLASH VALVE-IN-HEAD STRAIGHT-EIGHT • CHOICE OF STREAMBOARDS OR RUNNING BOARDS (SHOWN)

The Special

MODEL 46-S

This sport coupe for four has folding opera seats behind the driver's seat. Their arrangement is illustrated in the sketch.

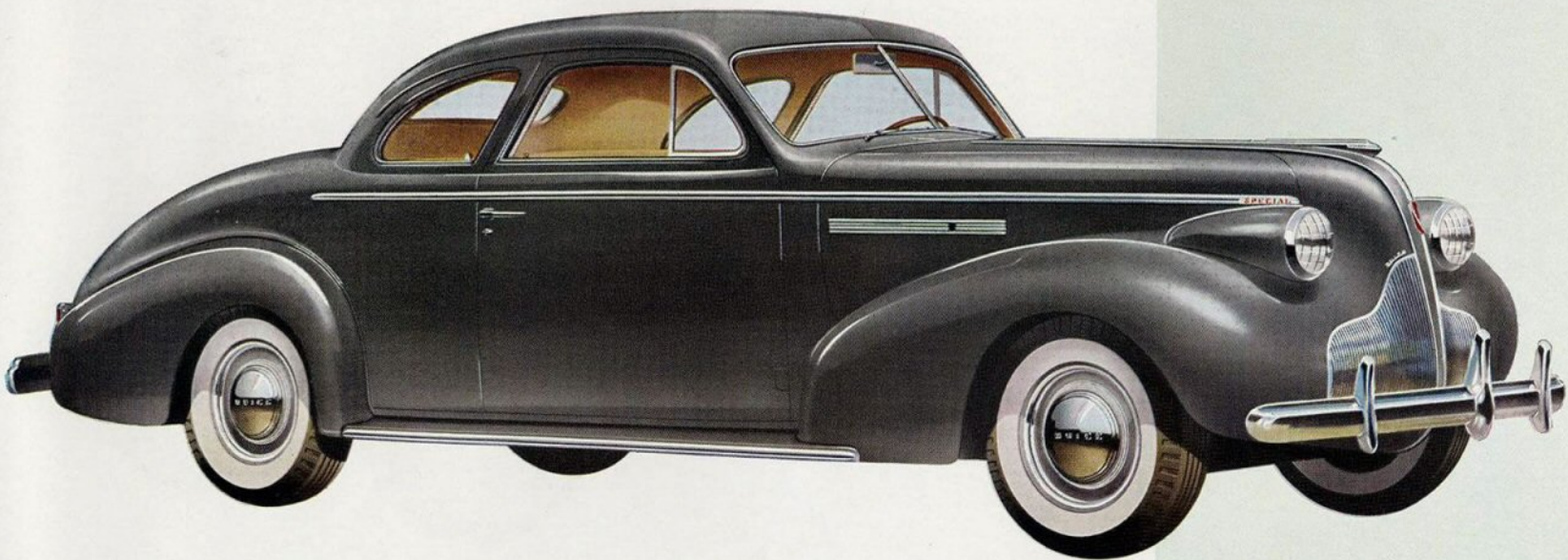

WHEELBASE: 120 INCHES • ENGINE: 107 HORSEPOWER DYNAFLASH VALVE-IN-HEAD STRAIGHT-EIGHT • CHOICE OF STREAMBOARDS OR RUNNING BOARDS (SHOWN)

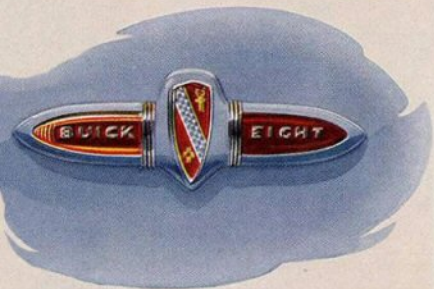

The Special

MODEL 41-C

This convertible four-door sport phaeton with trunk back carries five people in comfort. The Flash-Way direction signal lamp (lighted for left turn in sketch) is standard equipment.

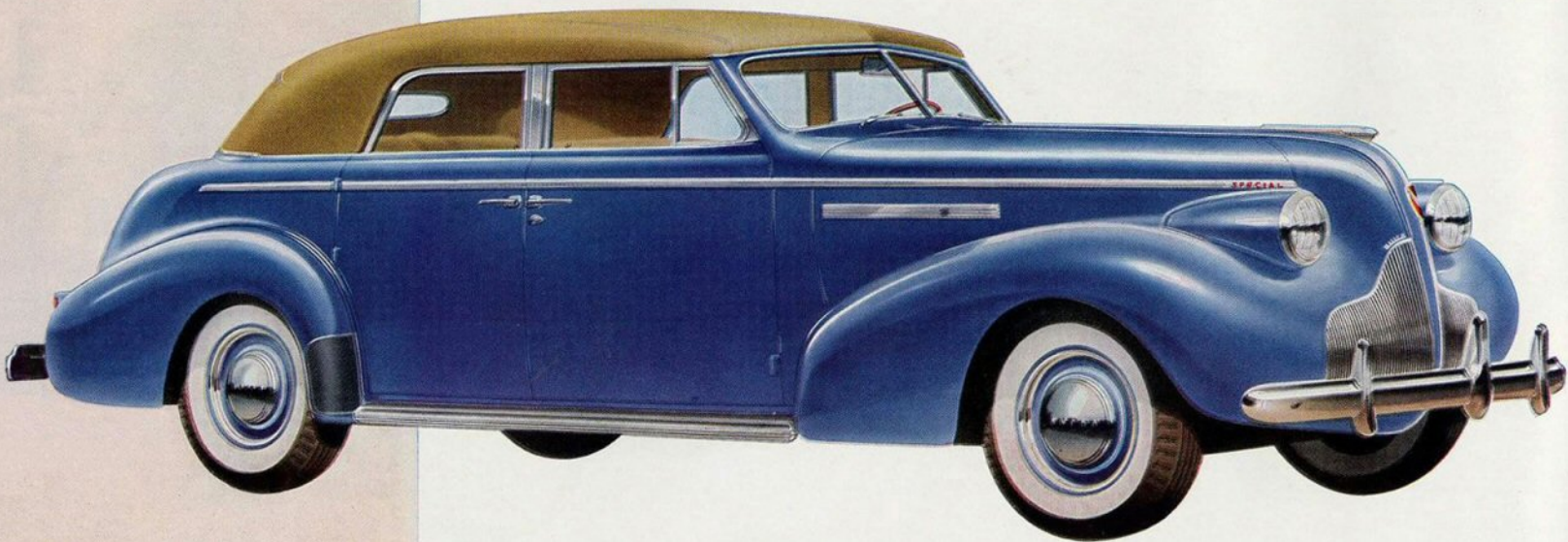

WHEELBASE: 120 INCHES • ENGINE: 107 HORSEPOWER DYNAFLASH VALVE-IN-HEAD STRAIGHT-EIGHT • CHOICE OF STREAMBOARDS (SHOWN) OR RUNNING BOARDS

The Special

MODEL 46-C

In this trim convertible coupe, folding opera seats under the top provide protection against the weather for two extra passengers.

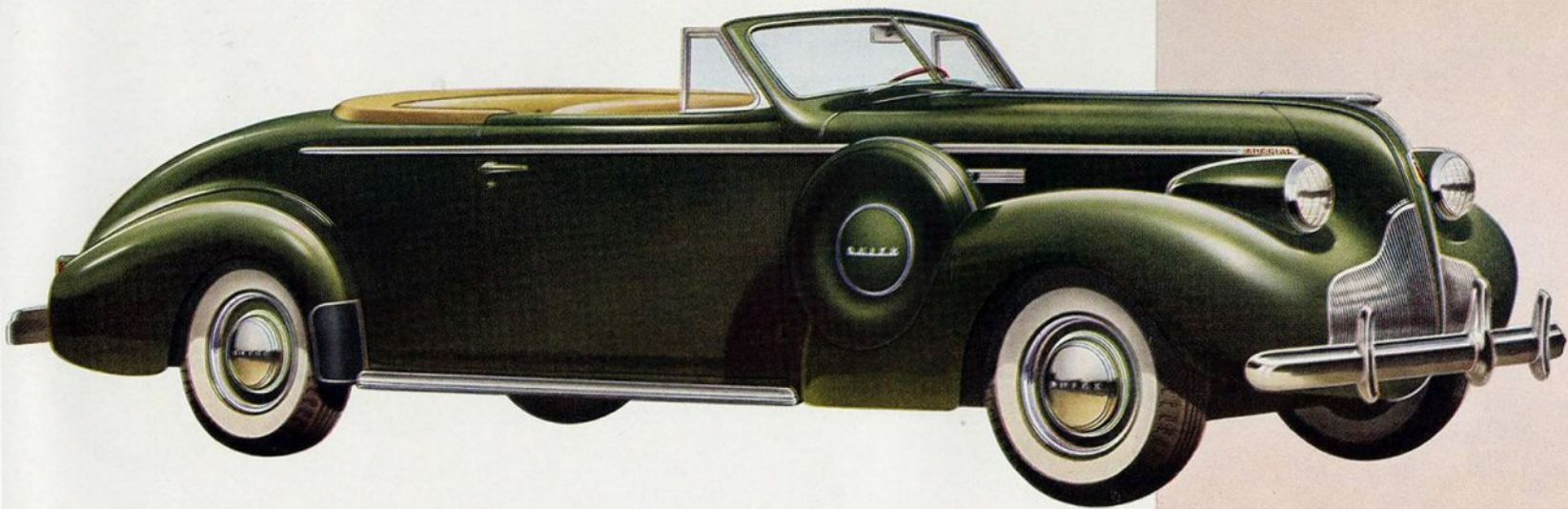

WHEELBASE: 120 INCHES • ENGINE: 107 HORSEPOWER DYNAFLASH VALVE-IN-HEAD STRAIGHT-EIGHT • CHOICE OF STREAMBOARDS (SHOWN) OR RUNNING BOARDS

The Special

MODEL 48

A five-passenger two-door sedan with trunk back. The sketch shows the ample entrance room to the rear seat. This model is also available with "Sunshine Turret Top" at slight extra cost.

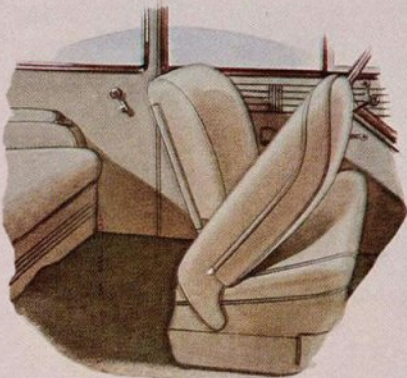
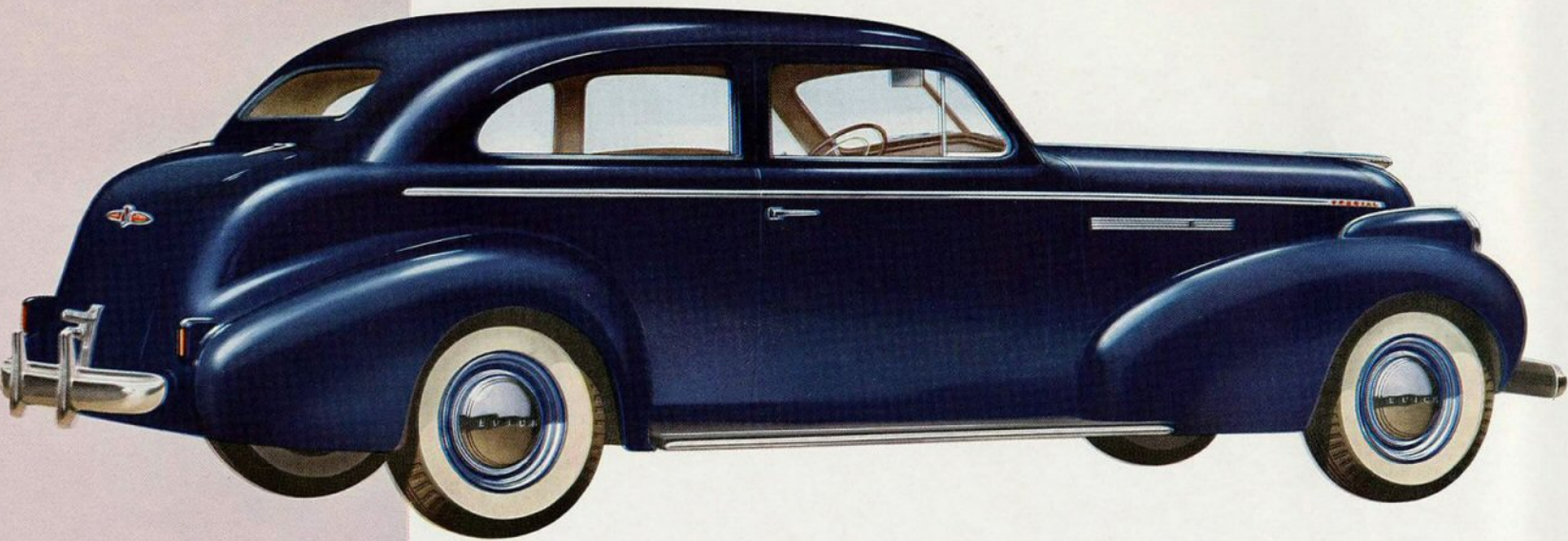

WHEELBASE: 120 INCHES • ENGINE: 107 HORSEPOWER DYNAFLASH VALVE-IN-HEAD STRAIGHT-EIGHT • CHOICE OF STREAMBOARDS OR RUNNING BOARDS (SHOWN)



Comfort and good taste are the keynotes of all Buick Special interiors. Upholstery material is Bedford cord or mohair. Rear floors are virtually "tunnel free." Convertible models may be ordered in leather or a combina-

tion of cloth and leather at no extra cost. Window and ventipane controls project only slightly, yet are designed for sure grip and easy operation. The rich-colored plastic knobs harmonize beautifully with interior trim.

*Birthplace of
Brilliant Action*

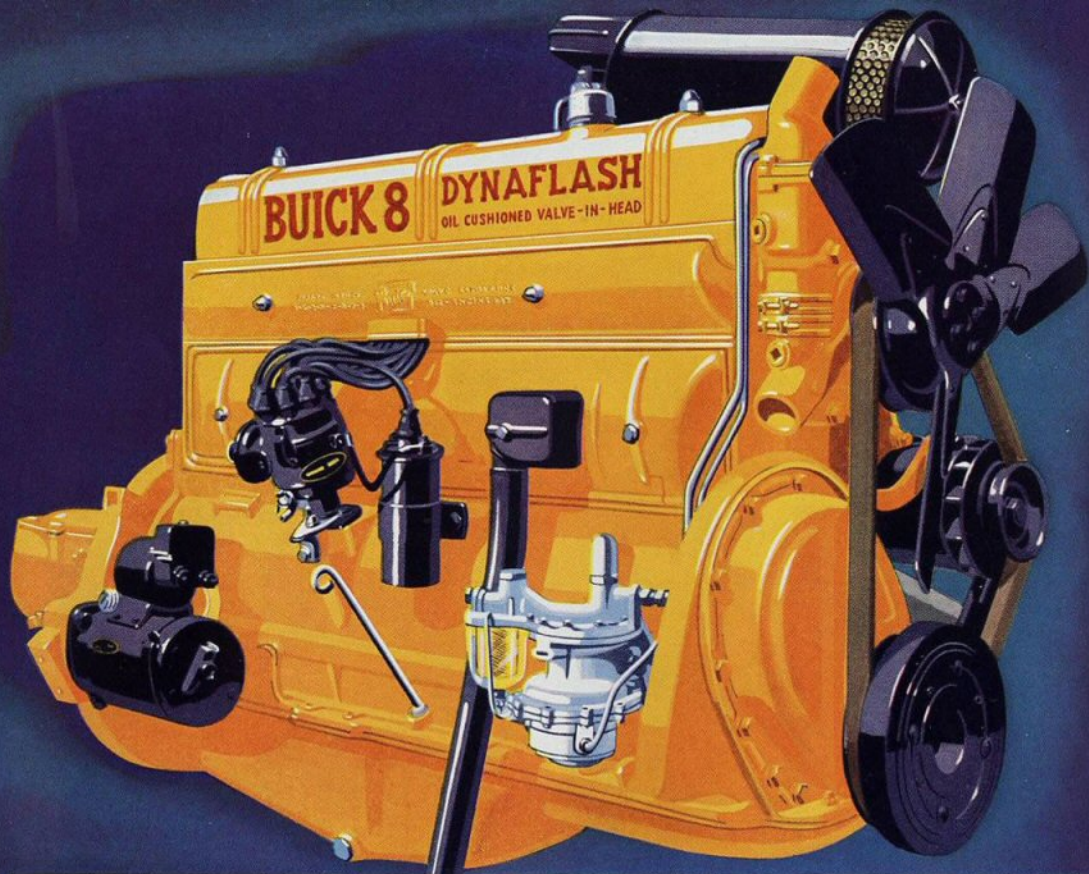

Batteries on all models are placed under the hood. In this convenient location they can be checked as readily as the oil, and are much less apt to be neglected.

Here's the heart of all the stirring action of these nimble Buicks—the great DYNAFLASH valve-in-head straight-eight engine. Size for size, no other engine can match it for efficiency and responsive power. Valve-in-head engines, a Buick feature for 35 years,

hold all records for speed on land, water and in the air. To the 10% greater efficiency provided by valve-in-head design, the DYNAFLASH principle adds close to 10% more power by its better control of combustion and increase in compression.

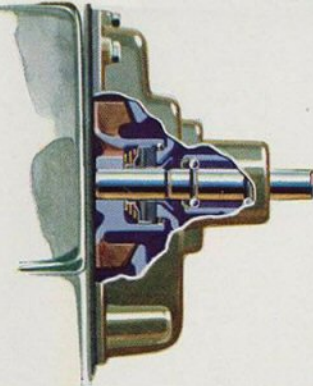

A new shaft seal of the carbon block type assures freedom from leakage and efficient operation of the water pump through the life of the car. The pump shaft has a new bearing which is lubricated and sealed for life.

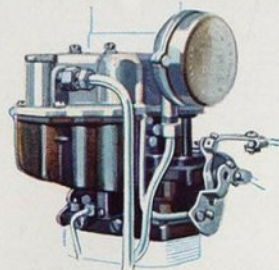

The operating simplicity of the new Series 40 fuel conditioner makes it an easy matter to get the most satisfactory fuel mixture and economy. Fuel feed is even and constant.

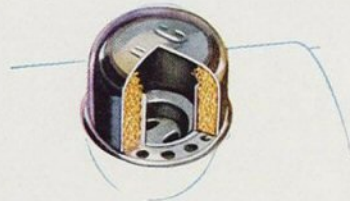

This breather cap filter on the engine prevents dust from entering and is part of the complete crankcase ventilation system which keeps oil in good condition by eliminating vapor and fumes that might form harmful acids in the crankcase.

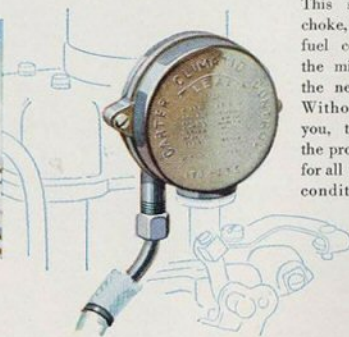

This simplified automatic choke, built as part of the fuel conditioner regulates the mixture according to the needs of the engine. Without attention from you, the engine receives the proper rationing of fuel for all the varying operating conditions it encounters.

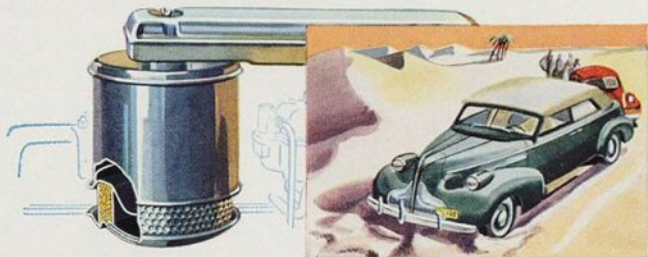

Air cleaners are of the horizontal type on all models. They have been made more efficient through simplification of design.

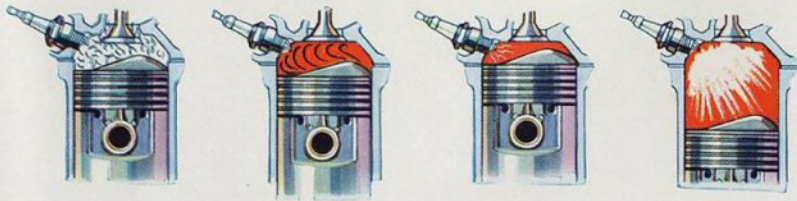

These four diagrams show how the DYNAFLASH engine extracts more good from gasoline—first by creating greater turbulence in the fuel charge—next, by putting more metal, relatively, in contact with the fuel charge and

so carrying away the excess heat that causes pre-ignition. As the spark leaps (third picture), flame travel spreads evenly without pre-ignition, with the final result that each downward power push is greater by almost 10%.

Crankshafts are meticulously balanced as shown at the right. One of the hundreds of instances of the painstaking precision that gives Buick its lasting smoothness.

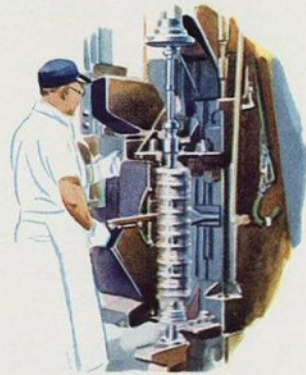

**Only Buick has
the Bui-coil
Full-Float Ride**

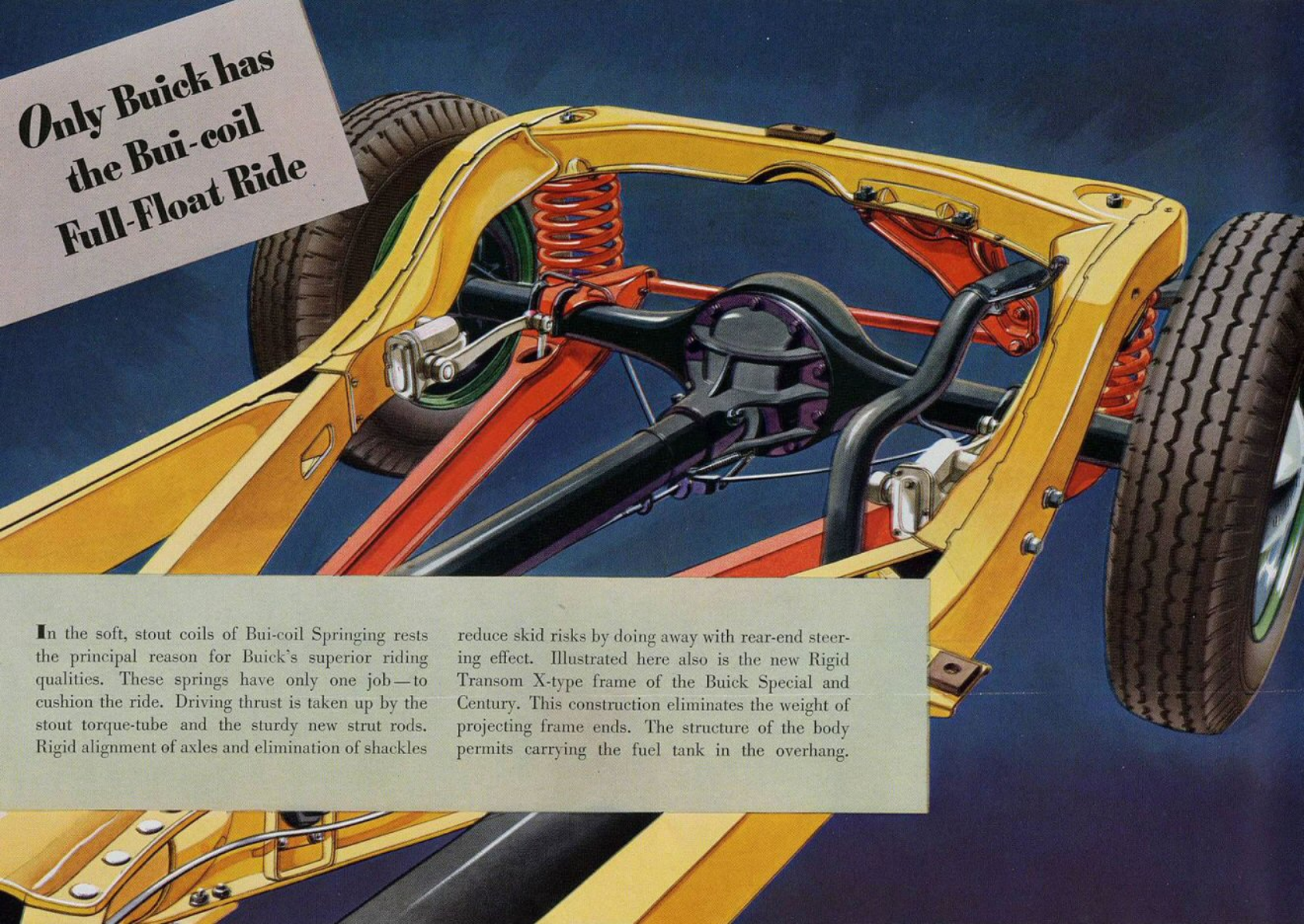

In the soft, stout coils of Bui-coil Springing rests the principal reason for Buick's superior riding qualities. These springs have only one job—to cushion the ride. Driving thrust is taken up by the stout torque-tube and the sturdy new strut rods. Rigid alignment of axles and elimination of shackles

reduce skid risks by doing away with rear-end steering effect. Illustrated here also is the new Rigid Transom X-type frame of the Buick Special and Century. This construction eliminates the weight of projecting frame ends. The structure of the body permits carrying the fuel tank in the overhang.

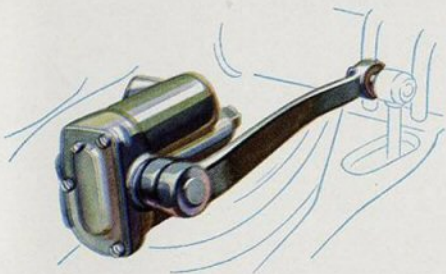

Shock absorbers are of the compact end-to-end discharge type, providing a continuously even resistance to road shock. Their costly and more substantial construction assures long life with freedom from trouble.

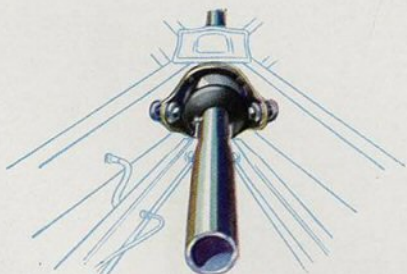

Placing the universal joint behind the cross-member of the frame allows floors to be lowered nearly two inches without the use of an objectionable tunnel. Specially treated rubber is vulcanized to the torque ball, making it perpetually self-lubricating.



The new Crown Spring clutch found in all Special models has only nine parts where 41 were required before. Simpler and stronger, it gives unlimited miles of trouble-free service. Driven plates have been redesigned for smoother, quicker shifting.

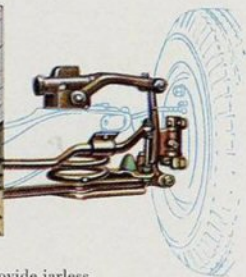

The soft-flexing steel coils of Knee-Action provide jarless springing. Pivoting is such that wheels camber at increased rate on curves, giving somewhat the effect of a banked turn.

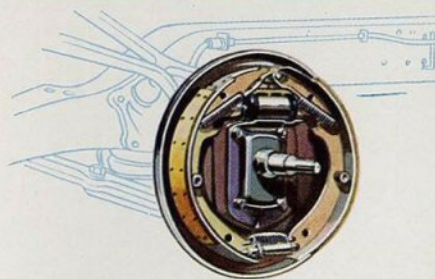

Buick hydraulic brakes are self-energizing—the motion of the car aids in applying them and makes sure, smooth, straight-line stops a reality. Wear is evenly distributed over linings, giving longer life.



This down view of the front end shows the new location of the stabilizer bar, ahead of the front cross-member on all Special and Century models. Diameter of this bar has been increased to $\frac{1}{2}$ inch.

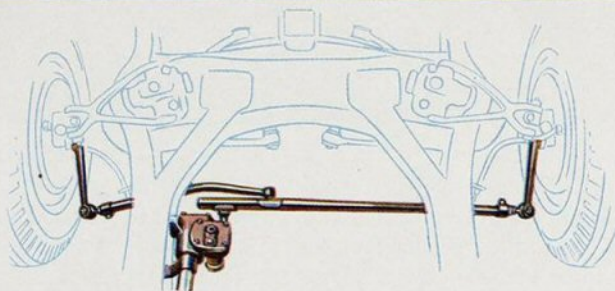

Combining with new geometry of the Knee-Action, steering linkage design makes for smooth, easy and steady response to the wheel and firm control at all speeds.

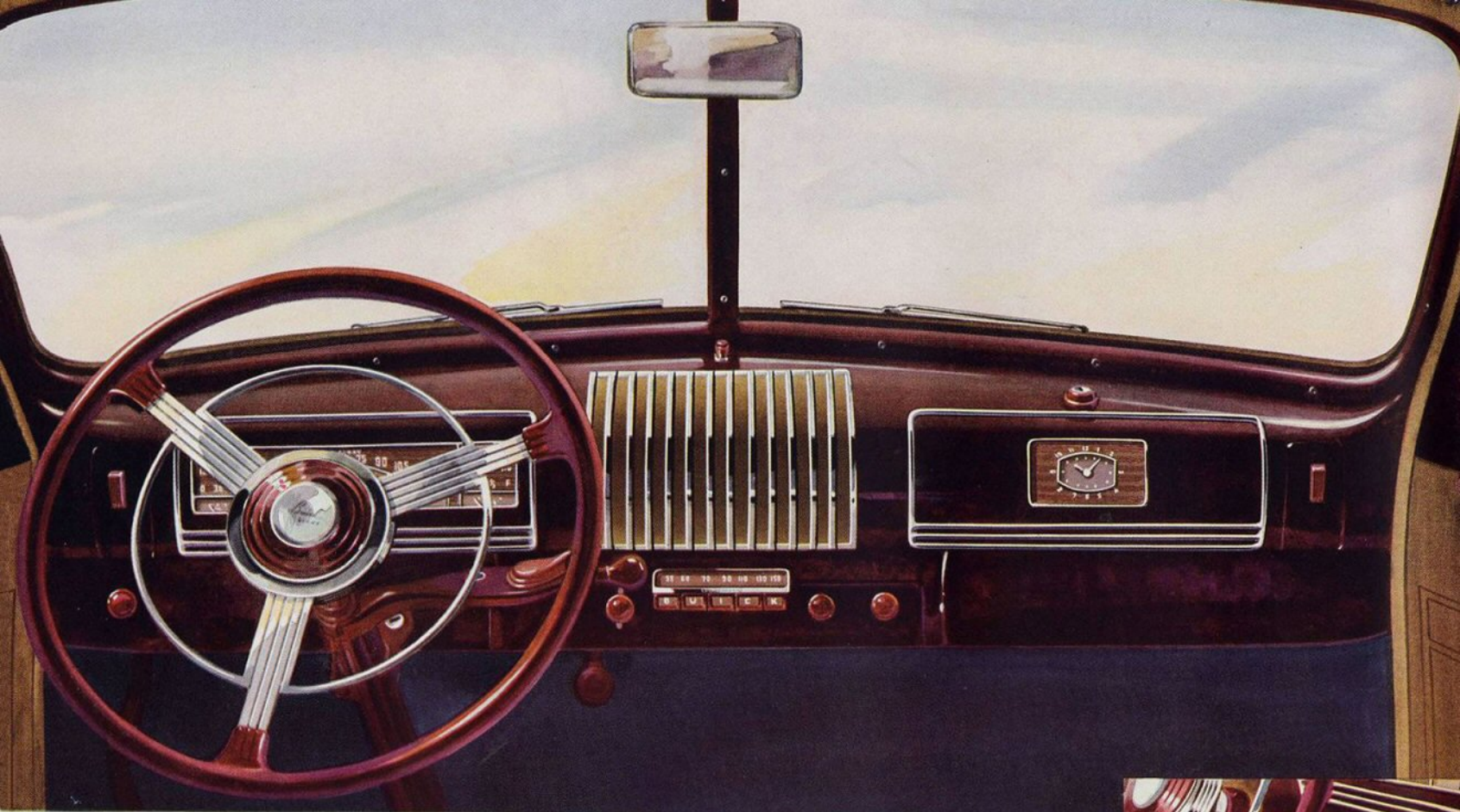

Visibility is the keynote in the new 1939 Buick, instanced not only by deeper windshields and windows but by the eye-line arrangement of all instruments. Speedometer and gauges are directly in the driver's line of vision, the throttle at his left hand, the light control at his right. And notice such conveniences as ash receivers at each side; an automatic lighter in easy reach of both driver and passenger; the windshield wiper knob which controls both speed and action; the large glove compartment with push-button release lock. The hand brake, at the extreme left under the instrument panel, locks in all positions, releases easily.

In all 1939 Buicks, gears are shifted with this simple "Handi-shift" bar, a few inches below the steering wheel. Shifting sequence follows the same H-pattern as conventional gear-shifts, so there is nothing new to learn about its use. The small switch operates the Flash-Way direction signal on the luggage compartment cover. A guide light flashes when this lamp is operating.

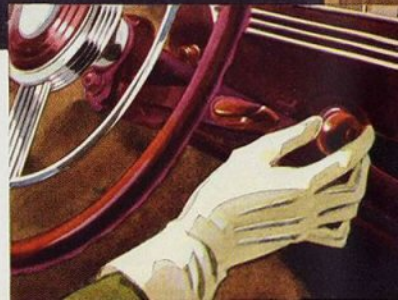

Instances of Buick's beauty and convenience are these interior and exterior details. Note that the ignition lock (1) is above the steering column, out of knee-way. The instrument cluster (2) is compactly arranged, directly in eye-line of the driver. An accurate electric clock (3) is mounted in the door of the glove compartment. Pull-type ash

receivers (4) are placed at each end of the instrument panel. A hood feature is the Louvlock (5), hood lock as well as a bonnet decoration. The Flash-Way direction signal (6) mounted on the trunk operates from a small switch on the shift-bar. It is shown here lighted for right turn. Series 40 and 60 models have freeze-free locks below both front door

handles (7)—80 and 90 series models have exterior locks in both front door handles. Electric cigar lighters (8) are automatic. Streamline tail-lights (9) reflect the light of approaching cars even when off. Massive chromium hub caps (10) are new in design. The fuel-tank filler pipe (11) is recessed under a flush door to prevent spillage of fuel on the finish.



1



2



3



4



5

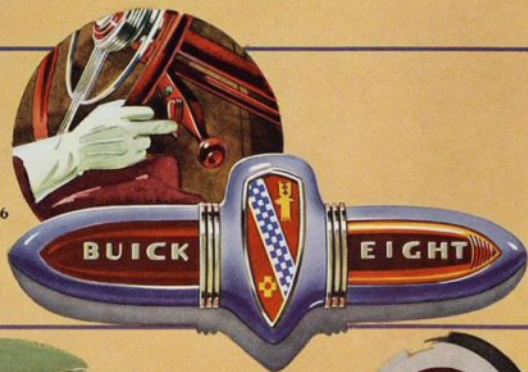

6

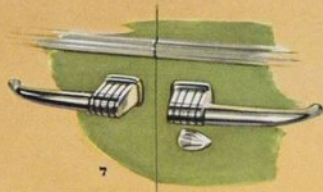

7



8



9



10



11

*No other car in
the world has all
these features*

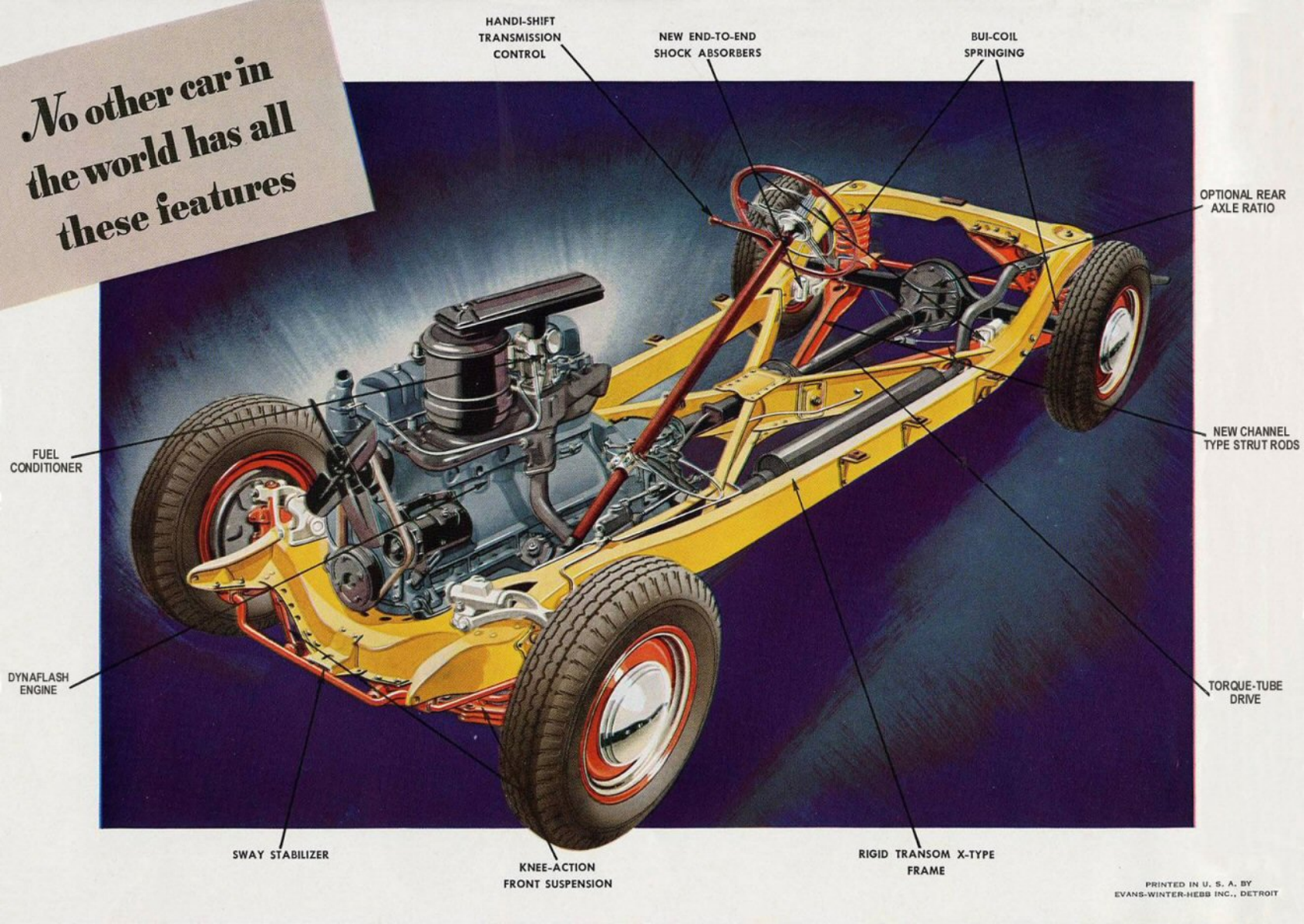

HANDI-SHIFT
TRANSMISSION
CONTROL

NEW END-TO-END
SHOCK ABSORBERS

BUI-COIL
SPRINGING

OPTIONAL REAR
AXLE RATIO

NEW CHANNEL
TYPE STRUT RODS

TORQUE-TUBE
DRIVE

FUEL
CONDITIONER

DYNAFLASH
ENGINE

SWAY STABILIZER

KNEE-ACTION
FRONT SUSPENSION

RIGID TRANSOM X-TYPE
FRAME

SPECIFICATIONS

LIMITED Series 90

BUICK VALVE-IN-HEAD STRAIGHT-EIGHT ENGINE—Bore and stroke, $3\frac{1}{8} \times 4\frac{1}{8}$ inches. Displacement, 320.18 cubic inches. Buick Turbulator Pistons. Compression ratio, 6.25 to 1. Developed horsepower, 141 at 3,600. Full-pressure lubrication to main, connecting rod, camshaft, and rocker arm bearings. Counterweighted crankshaft with torsional balancer. Filtered crankcase ventilation. Oil capacity, 8 quarts.

FUEL AND COOLING SYSTEM—Dual downdraft carburetor. Thermostatic heat control, automatic choke, automatic idle control. Intake silencer and air cleaner. Fuel filter. By-pass water temperature control. Concealed gas tank filler. Fuel tank capacity, 20 gallons. Water capacity, 17 quarts.

CLUTCH AND TRANSMISSION—Single dry plate clutch. Facing area, 107.0 square inches. All-silent Synco-Mesh transmission, helical gears. Handi-shift transmission control.

REAR AXLE—Semifloating rear axle with hypoid gears. Torque tube drive. Rear axle ratio, 4.555 to 1. One universal joint automatically lubricated from transmission.

SUSPENSION—Independent front wheel suspension with ride stabilizer. Torque-free rear springing. All coil springs.

STEERING—Worm and double roller. Ratio 22 to 1. Center point control.

FRAME—Girder X-type frame, $9 \times 2\frac{3}{4} \times \frac{1}{8}$.

SHOCK ABSORBERS—Front, double-acting integral with independent suspension unit. Rear, double-acting end-to-end type.

BRAKES—Four-wheel hydraulic. Cast-iron ribbed brake drums. Size, 14 x 2 inches. Mechanical parking brake.

ELECTRICAL SYSTEM—Delco-Remy, two unit, 6-8 volt. Solenoid starter with dual control. Multibeam headlights with foot dimmer switch. Battery mounted under hood. "High output" generator with voltage regulator. Flash-Way direction signal.

WHEELS AND TIRES—Demountable steel disc wheels. Tire size, 16 x 7.50, 6-ply.

WHEELBASE—140 inches.

ROADMASTER Series 80

BUICK VALVE-IN-HEAD STRAIGHT-EIGHT ENGINE—Bore and stroke, $3\frac{1}{8} \times 4\frac{1}{8}$ inches. Displacement, 320.18 cubic inches. Buick Turbulator Pistons. Compression ratio, 6.25 to 1. Developed horsepower, 141 at 3,600. Full-pressure lubrication to main, connecting rod, camshaft, and rocker arm bearings. Counterweighted crankshaft with torsional balancer. Filtered crankcase ventilation. Oil capacity, 8 quarts.

FUEL AND COOLING SYSTEM—Dual downdraft carburetor. Thermostatic heat control, automatic choke, automatic idle control. Intake silencer and air cleaner. Fuel filter. By-pass water temperature control. Concealed gas tank filler. Fuel tank capacity, 20 gallons. Water capacity, 17 quarts.

CLUTCH AND TRANSMISSION—Single dry plate clutch. Facing area, 107.0 square inches. All-silent Synco-Mesh transmission, helical gears. Handi-shift transmission control.

REAR AXLE—Semifloating rear axle with hypoid gears. Torque tube drive. Rear axle ratio, 4.182 to 1. One universal joint automatically lubricated from transmission.

SUSPENSION—Independent front wheel suspension with ride stabilizer. Torque-free rear springing. All coil springs.

STEERING—Worm and double roller. Ratio 22 to 1. Center point steering control.

FRAME—Girder X-type frame, $9 \times 2\frac{3}{4} \times \frac{1}{8}$.

SHOCK ABSORBERS—Front, double-acting integral with independent suspension unit. Rear, double-acting end-to-end type.

BRAKES—Four-wheel hydraulic. Cast-iron ribbed brake drums. Size, 12 x 2 inches. Mechanical parking brake.

ELECTRICAL SYSTEM—Delco-Remy, two unit, 6-8 volt. Solenoid starter with dual control. Multibeam headlights with foot dimmer switch. Battery mounted under hood. "High output" generator with voltage regulator. Flash-Way direction signal.

WHEELS AND TIRES—Demountable steel disc wheels. Tire size, 16 x 7.00, 4-ply.

WHEELBASE—133 inches.

CENTURY Series 60

BUICK VALVE-IN-HEAD STRAIGHT-EIGHT ENGINE—Bore and stroke, $3\frac{1}{8} \times 4\frac{1}{8}$ inches. Displacement, 320.18 cubic inches. Buick Turbulator Pistons. Compression ratio, 6.25 to 1. Developed horsepower, 141 at 3,600. Full-pressure lubrication to main, connecting rod, camshaft, and rocker arm bearings. Counterweighted crankshaft with torsional balancer. Filtered crankcase ventilation. Oil capacity, 8 quarts.

FUEL AND COOLING SYSTEM—Dual downdraft carburetor. Thermostatic heat control, automatic choke, automatic idle control. Intake silencer and air cleaner. Fuel filter. By-pass water temperature control. Concealed gas tank filler. Fuel tank capacity, 18 gallons. Water capacity, 17 quarts.

CLUTCH AND TRANSMISSION—Single dry plate clutch. Facing area, 107.0 square inches. All-silent Synco-Mesh transmission, helical gears. Handi-shift transmission control.

REAR AXLE—Semifloating rear axle with hypoid gears. Torque tube drive. Rear axle ratio, regular 3.9 to 1; optional 3.615 to 1. One universal joint lubricated for life.

SUSPENSION—Independent front wheel suspension with ride stabilizer. Torque-free rear springing. All coil springs.

STEERING—Worm and double roller. Ratio 19 to 1. Direct cross steering.

FRAME—Rigid transom X-type, $6 \times 2\frac{3}{4} \times \frac{1}{8}$.

SHOCK ABSORBERS—Front, double-acting integral with independent suspension unit. Rear, double-acting end-to-end type.

BRAKES—Four-wheel hydraulic. Centrifuge brake drums. Size, 12 x 2 inches. Mechanical parking brake.

ELECTRICAL SYSTEM—Delco-Remy, two unit, 6-8 volt. Solenoid starter with dual control. Multibeam headlights with foot dimmer switch. Battery mounted under hood. "High output" generator with voltage regulator. Flash-Way direction signal.

WHEELS AND TIRES—Demountable steel disc wheels. Tire size, 15 x 7.00, 4-ply.

WHEELBASE—126 inches.

SPECIAL Series 40

BUICK VALVE-IN-HEAD STRAIGHT-EIGHT ENGINE—Bore and stroke, $3\frac{1}{8} \times 4\frac{1}{8}$ inches. Displacement, 248 cubic inches. Buick Turbulator Pistons. Compression ratio 6.1 to 1. Developed horsepower, 107 at 3,400. Full-pressure lubrication to main, connecting rod, camshaft, and rocker arm bearings. Counterweighted crankshaft with torsional balancer. Filtered crankcase ventilation. Oil capacity, 6 quarts.

FUEL AND COOLING SYSTEM—Dual downdraft carburetor. Thermostatic heat control, automatic choke, automatic idle control. Intake silencer and air cleaner. Fuel filter. By-pass water temperature control. Concealed gas tank filler. Fuel tank capacity, 18 gallons. Water capacity, 13 $\frac{1}{4}$ quarts.

CLUTCH AND TRANSMISSION—Crown spring, single dry plate clutch. Facing area, 80.0 square inches. All-silent Synco-Mesh transmission, helical gears. Handi-shift transmission control.

REAR AXLE—Semifloating rear axle with hypoid gears. Torque tube drive. Rear axle ratio: regular, 4.444 to 1; optional, 3.9 to 1. One universal joint lubricated for life.

SUSPENSION—Independent front wheel suspension with ride stabilizer. Torque-free rear springing. All coil springs.

STEERING—Worm and double roller. Ratio 19 to 1. Direct cross steering.

FRAME—Rigid transom X-type, $6 \times 2\frac{3}{4} \times \frac{1}{8}$.

SHOCK ABSORBERS—Front, double-acting integral with independent suspension unit. Rear, double-acting end-to-end type.

BRAKES—Four-wheel hydraulic. Centrifuge brake drums. Size, 12 x 1 $\frac{3}{4}$ inches. Mechanical parking brake.

ELECTRICAL SYSTEM—Delco-Remy, two unit, 6-8 volt. Solenoid starter with dual control. Multibeam headlights with foot dimmer switch. Battery mounted under hood. "High output" generator with voltage regulator. Flash-Way direction signal.

WHEELS AND TIRES—Demountable steel disc wheels. Tire size, 16 x 6.50, 4-ply.

WHEELBASE—120 inches.

Buick Motor Division, General Motors Sales Corporation, reserves the right to make changes in specifications or equipment at any time without incurring any obligation to install them on cars previously sold.

Your car is an investment, paying dividends in pleasurable and useful service. Like all investments, it repays in larger measure when it receives adequate attention to its upkeep. Your Buick dealer is a specialist in maintaining the smoothly brilliant performance of this car—his mechanics have the benefit of factory training and his equipment is selected for use in servicing Buicks. Make him your friend and counsellor in keeping your car in perfect trim, and the small cost of his services will be more than repaid in greater satisfaction and pleasure from your car.

Organized for the use of General Motors Dealers only and their customers, The General Motors Acceptance Corporation has taken the lead in reducing the cost of financing car purchases. Its financing cost including adequate insurance is as low as that of any well established financing organization and in many cases lower. Terms can be arranged to suit your convenience and courteous treatment is assured at all times. A comparison of costs will show the advantages of purchasing a Buick on the convenient General Motors Instalment Plan operated by GMAC.



