

RAM
COMMERCIAL

2017

RAM 1500

BEST-IN-CLASS³ 29 MPG HWY¹
10,620-LB MAX TOWING²
1,880-LB MAX PAYLOAD²

MORE ON PG 19

RAM HEAVY DUTY

2500/3500

UP TO 900 LB-FT MAX DIESEL TORQUE (3500)
MAX TOWING²
17,980-LB (2500) • 31,210-LB (3500)
MAX PAYLOAD²
3,990-LB (2500) • 7,390-LB (3500)

MORE ON PG 9

RAM CHASSIS CAB

3500/4500/5500

UP TO 750 LB-FT MAX DIESEL TORQUE
MAX TOWING²
23,770-LB (3500) • 25,650-LB (4500) • 30,600-LB (5500)
MAX GCWR²
31,000-LB (3500) • 33,500-LB (4500) • 38,500-LB (5500)

MORE ON PG 4



**AMERICA'S
LONGEST-LASTING
PICKUPS**^{1*}

**AMERICA'S
MOST EFFICIENT
WORK VAN**²

WE'RE READY TO FACE YOUR TOUGHEST JOBS.

RAM PROMASTER[®] CARGO VAN/CHASSIS CAB

4,430-LB CARGO VAN MAX PAYLOAD³
5,100-LB CARGO VAN MAX TOWING³
CLASS-EXCLUSIVE⁴ FRONT-WHEEL DRIVE

BEST-IN-CLASS⁴: STANDARD CARGO HEIGHT, WIDTH BETWEEN WHEEL WELLS, MAX CARGO WIDTH, LOWEST LOAD FLOOR HEIGHT, TURNING DIAMETER (SHORT WHEELBASE)

MORE ON PG 22

RAM PROMASTER CITY[®] CARGO VAN/PASSENGER WAGON

BEST-IN-CLASS⁵ HWY FUEL ECONOMY—28 MPG HWY^{**}
BEST-IN-CLASS⁵ CARGO CAPACITY (CARGO VAN)
BEST-IN-CLASS⁵ PAYLOAD (CARGO VAN)

MORE ON PG 25

^{*}A note about this catalog: all disclaimers and disclosures can be found on the inside back cover.
¹Manufacturer's estimated 29 mpg hwy based on Ram 1500 EcoDiesel HFE 4x2. Actual results may vary.
²When properly equipped. ^{**}EPA estimated 21 mpg city/28 mpg hwy. Actual results may vary.

RAM. IT'S A NAME THAT DEFIES CONVENTIONAL THINKING—AND DEFINES CONVICTION OF PURPOSE.

If you're looking for one reason why we've developed an award-winning portfolio of hard-working vehicles, it's this: to deliver unquestionable leadership that pays off.

Short and sweet, we get it. Our engineers and designers know that commercial-grade vehicles must stand up to rigors and demands that far exceed those of civilian life. They must stand apart from every competitive vehicle—with reliability, strength and efficiency. They must deliver it all: performance, durability, quality, comfort—exactly what you get when you employ a Ram truck to do the job. Whether it's business, industry, agriculture or demanding personal or recreational needs, you need to master that task in front of you. Your Ram truck of choice stands ready.

THE CONSTRUCT. For Ram Chassis Cabs and pickups, it's all no-nonsense from Day One. Count on a high-strength steel core with ultra-tough crossmembers working with hydroformed tubular front frame units. For Ram ProMaster® and Ram ProMaster City® models, tough unibody construction means upfit-ready interiors backed with powertrains that ensure efficient performance.

THE BOXES. High-strength steel rules, but convenience is key—which is why Ram pickups feature cargo areas engineered for payload and built for ease of operation. Advantages like CHMSL-mounted lights and available rear LED Bed Lighting are augmented by a stand-alone asset: the available and innovative RamBox® Cargo Management System.



THE CAPABILITY. This portfolio encourages you to demand superior performance—because that's our benchmark. The basic workhorse, Ram 1500, features a structural rear bumper rated for Class III towing, letting you capably handle trailers up to 5,000 lb.* Need more? Ram 3500 Heavy Duty pickups powered by an available Cummins® High Output Turbo Diesel tow up to 31,210 lb.* Measure capability by GCWR, and Ram 5500 delivers—up to a remarkable 38,500 lb.*

If the Ram ProMaster models are your go-to vehicle, Cargo Van is rated up to 5,100 lb* of pure towing capability. The urban-friendly ProMaster City Cargo Van tows up to 2,000 lb.*

100% CAPABILITY. ZERO COMPROMISES. RAM. HOW YOU'LL MASTER EVERY JOB OUT THERE.



THE PERFORMANCE. This commercial portfolio is designed with bottom-line principles. Thus, you're looking at exponentially thousands of miles and decades of service—numbers which translate into durable strength backed with operational efficiencies.

Contributors to enviable fuel efficiency on Ram models include sculpted aerodynamic bodies, and, on pickups, available assets like wheel-to-wheel side steps and Active Grille Shutters (1500 only).



Accomplishments in design join powertrain ingenuity. Engine choices for Ram models range from the proficient 2.4L Tigershark® to the groundbreaking EcoDiesel V6† to the legendary HEMI® V8s to the formidable Cummins® Turbo Diesel powerplants.

THE INTERIORS. Every worker in this portfolio delivers multiple advantages simultaneously. Capability is a given. Reliability is built-in. And driver and occupant comfort is key.

And every Ram model delivers, with interiors that reflect thoughtful and intuitive design. From window controls and door handles to the dashboard-mounted Rotary Shifter for the TorqueFlite® 8-speed automatic on Ram 1500, buttons and controls are driver- and passenger-friendly. Storage in every model is abundant, with select pickups supplying an available fold-flat cargo load floor and/or convenient in-floor removable and drainable storage bins.

From the premium leather of Ram Laramie Longhorn® and Limited models to the easy-to-clean and comfortable cloth seating of the Ram ProMaster® family, style and comfort never take a back seat.

THE INGENUITY. Our commercial team realized the power of innovation decades ago; you're reaping the benefits of years of research and development every day you drive your Ram vehicle.

Pioneering inventiveness in the flagship Ram 1500 encompasses many areas. Among them: the class-exclusive⁶ multilink coil spring rear suspension. The class-exclusive⁶ available five-mode Active-Level™ Four-Corner Air Suspension System. The abundant storage from the available best-in-class⁶ RamBox® Cargo Management System. And the introduction of the available EcoDiesel V6† powerplant.

This winning team knows business inside out. Count on capability that strives to exceed 100% 24/7/365. And count on the promise of zero compromises. For more, visit

RAMTRUCKS.COM/COMMERCIAL

*When properly equipped. †Late availability. Properly secure all cargo.

RAM CHASSIS CABS: MORE PTO OPTIONS, BIG TORQUE AND BIG RETURNS.

UNSURPASSED⁷ MAX GVWR OF 19,500 LB* (5500); OPTIONAL CUMMINS[®] TURBO DIESEL | CLASS-EXCLUSIVE⁸ STANDARD AISIN[®] TRANSMISSION | UNSURPASSED⁸ AVAILABLE TORQUE: 750 LB-FT, CUMMINS[®] TURBO DIESEL



TOUGH, RESILIENT, EFFICIENT: RAM 4500/5500 CHASSIS CABS.

- + **BEST-IN-CLASS⁹ MAX GCWR*: RAM 4500.** Put massive capability at your service. The robust Ram 4500 Chassis Cab measures up, with up to 33,500 lb of ready-to-work GCWR.
- + **UNSURPASSED⁹ GAS- AND DIESEL-POWERED MAX GVWR*: RAM 4500.** The 6.4L HEMI[®] V8 and the 6.7L Cummins Turbo Diesel both offer a GVWR up to 16,500 lb.
- + **UNSURPASSED⁷ GAS- AND DIESEL-POWERED MAX GVWR*: RAM 5500.** The 6.4L HEMI V8 and the 6.7L Cummins Turbo Diesel both offer a GVWR up to 19,500 lb.
- + **BEST-IN-CLASS⁹ DIESEL MAX TRAILER WEIGHT*: RAM 4500.** Towing strength from these workers is at the apex: up to 25,650 lb for Ram 4500 when equipped with the optional Cummins Turbo Diesel powerplant.
- + **BEST-IN-CLASS⁷ GAS-POWERED MAX TRAILER WEIGHT*: RAM 5500.** Tow up to 18,960 lb with a Ram 5500 powered by the 6.4L HEMI V8 engine.
- + **BEST-IN-CLASS⁸ MAXIMUM FRONT GAWR*: GAS- AND DIESEL-POWERED RAM 4500/5500.** With the standard 6.4L HEMI V8, these heavyweights are rated up to 7,000 lb. With the optional Cummins Turbo, front support rises to a super-capable 7,250 lb.
- + **BEST-IN-CLASS⁸ OIL CHANGE INTERVALS: GAS- AND DIESEL-POWERED RAM 4500/5500.** Oil changes with the 6.4L HEMI V8 can stretch up to 10,000 miles; with the optional Cummins Turbo, intervals can reach up to 15,000 miles.

*When properly equipped. Properly secure all cargo.



Vocational upfit provided by Knapheide.

TWO PTO OPTIONS. COUNTLESS JOB SOLUTIONS.

WE EXAMINED EVERY POWER TAKE-OFF POSSIBILITY. AND THEN WE RAN WITH IT. Ram Chassis Cab is the go-to source when add-on capability gets the job done. Our available Power Take-Off functionality is the result of ongoing PTO prep research and development. Industry benefits from sheer power: PTO on 4500/5500 Chassis Cabs delivers up to 60 horsepower and 250 lb-ft of torque.

PTO options include choices from the Cummins Turbo Diesel and the gas-powered 6.4L HEMI[®] V8. With the available Cummins powering your Ram Chassis Cab, count on a class-exclusive⁹ G56 six-speed manual transmission or the AISIN Heavy-Duty six-speed automatic; the AISIN is standard on 4500/5500 with the 6.4L HEMI V8. Both engines allow the AISIN to perform to spec: the AISIN can accommodate both right-side mountings and left-side PTO accessibility.

The higher horsepower output from split-shaft PTO capability (with the Cummins only) is ideal for large generators, pumps, compressors and oil field applications. Left-side PTO (AISIN only) offers easy installation, with clearance for hydraulic or shaft-driven PTO units. The right side offers some 20% larger space for substantial transmission-mounted PTO units, with convenient in-cab floor access. Technical questions? Answers are a click away, at RAMBODYBUILDER.COM



These PTO sending units are shown here as mounted on the AISIN Heavy-Duty six-speed automatic. Blue unit: Ram 4500 4x2 with left-side-mounted PTO and mechanical componentry. Red unit: on a Ram 4500 Chassis Cab 4x4, a right-side-mounted PTO sending unit, here with hydraulic pump componentry. Each PTO prep option is engineered to solve a wide range of ancillary needs.

RAM 4500/5500 CHASSIS CAB

**THE GCWR STRETCHES UP TO 38,500 LB* THE TOWING REACHES UP TO 30,600 LB*
RAM 4500/5500 ARE THE WORKERS THAT EAGERLY TAKE ON THE TOUGHEST JOBS.**



AT A GLANCE, 2017 RAM CHASSIS CABS HAUL WITH CONFIDENCE. MAX GCWRs AND TOWING:

MODEL	MAX GCWR [†]	DIESEL MAX TOWING [†]
4500	33,500 lb	25,650 lb
5500	38,500 lb	30,600 lb

The top jobs always go to the most accomplished employees. The singular strengths of the 2017 Ram 4500/5500 Chassis Cabs are conclusive proof that these guys have what it takes to get big tasks done, and done right.

This is where advantages like best-in-class^{7,9} max trailer weight ratings[†] for gas (Ram 5500) and diesel (Ram 4500) engines outdo those of the competition. It's where a standard 6.4-liter HEMI[®] V8 stands out with its available PTO-activated Multi-Displacement System (MDS) capability in static mode. It's where available V8 gas-powered PTO capability includes available left- or right-side access. And it's where the available 6.7-liter Cummins[®] High Output Turbo Diesel churns out 750 lb-ft of torque.

AVAILABLE DUAL ALTERNATOR ELECTRICAL OUTPUT WITH BOTH ENGINES. With the 6.4L HEMI V8 gas engine, get a total of 380 amps. The 6.7L Cummins Turbo Diesels kick it up to dual 220-amp units, for a best-in-class⁸ available 440 total amps.

MINIMAL LEVELS OF NVH. What were once the bane of the work truck are now significantly lessened. The 2017 Ram 4500/5500 Chassis Cabs are specifically tuned to reduce noise, vibration and harshness (NVH). These powerhouses are built from the ground up for impressively silent operation.

AVAILABLE PARKVIEW[®] REAR BACK-UP CAMERA.¹⁰ It's packaged as a stand-alone unit—the best means to let you and your upfitter determine its ideal placement. The visual display lets you zero in on a trailer hitch or a loading dock floor.

COMPREHENSIVE ELECTRONIC STABILITY CONTROL (ESC)¹¹ SYSTEM, STANDARD. It's all right here: ABS, Electronic Brake-Force Distribution, All-Speed Traction Control, Ready Alert Braking, Rain Brake Support, Engine Drag Control, Trailer Sway Damping¹²—and much more.



THE POWER OF PTO. Shown in Red: transmission-mounted PTO sending unit and split-shaft PTO element.

IT'S DESIGNED FROM THE UPFITTER'S POINT OF VIEW, so rigid standards include a heavy-duty flat frame with 34-inch rail spacing—and all components outside the main upfit areas. Rear frame steel strength of 50,000 psi on both Ram 4500/5500 clinches the deal.

GAINING CONTROL WITH STOPPING POWER. Brakes on Ram 4500/5500 Chassis Cabs employ Power Assist with hydro-boost technology. Authoritative twin-piston pin slider calipers work in tandem with over-15-inch rotors.



RAM 4500 CHASSIS CAB

MAX GVWR: 16,500 LB[†] • MAX GCWR: 33,500 LB[†]

Best-in-class⁹ diesel max trailer weight rating—up to 25,650 lb[†]
Best-in-class⁹ available diesel front GAWR—7,250 lb[†]
 Upfit-ready rear frame steel strength of 50,000 psi
 Invaluable available diesel hp and torque—up to 325 hp/750 lb-ft

Unsurpassed⁹ max GVWR with the 6.4-liter HEMI V8—up to 16,500 lb[†]
Unsurpassed⁹ max GVWR with the 6.7-liter Cummins Turbo—up to 16,500 lb[†]

*Ram 5500; when properly equipped. †When properly equipped.

RAM 5500 CHASSIS CAB

MAX GVWR: 19,500 LB[†] • MAX GCWR: 38,500 LB[†]

Best-in-class⁹ available dual fuel tank capacity—74 gallons
Best-in-class⁹ diesel oil change intervals—up to 15,000 miles
Work-eager diesel max trailer weight rating—up to 30,600 lb[†]
 Upfit-ready rear frame steel strength of 50,000 psi

Huge front and rear brake rotors measure up—over 15 inches in diameter
Unsurpassed⁷ max GVWR with the 6.7-liter Cummins Turbo—up to 19,500 lb[†]



**TURBO DIESEL****UP TO 325 HP/750 LB-FT TORQUE**

In this iteration for the weight class, the available 6.7L Cummins® High Output Turbo Diesel for the Ram Chassis Cab family is calibrated to a robust 325 horsepower backed with up to 750 lb-ft of on-demand torque. In Ram 4500 Chassis Cab, you've got a best-in-class⁹ diesel-powered max trailer weight.[†]

RAM 3500 CHASSIS CAB

STANDARD 6.4L HEMI® V8. MASSIVE GCWR. A JAW-DROPPING LIST OF BEST-IN-CLASS STRENGTHS. THIS CHASSIS CAB DOES THE JOB LIKE NO OTHER.



Few vehicles in the 3500 weight class can vie with Ram 3500 Chassis Cab. The facts are indisputable: while the many top-of-the-class figures discussed on this page leave competitive models gasping for air, a Ram 3500 Chassis Cab barely needs to take a breath between assignments.

Ram 3500 Chassis Cab simply delivers the numbers that do the job and help save valuable time. Like best-in-class¹² oil change intervals: for diesel engines, it's 15,000 miles; for gas, 10,000 miles. Like the 52-gallon, best-in-class¹² largest single rear-mounted fuel tank, and the best-in-class¹² 74-gallon available dual fuel tank capacity. Ram 3500 Chassis Cab capably demonstrates how all the right numbers add up for business success.

FROM UPFIT TO AMPS TO TOUCHSCREEN, THE RAM 3500 CHASSIS CAB ELECTRONICS SET THE BENCHMARK.

POWER TO THE PEOPLE. AND FOR THE JOB. This is how you build a Chassis Cab that excels in the field: employ the sophistication of PowerNet electrical architecture. Add the available upfitter-ready electrical module with its 50+ inputs/outputs. Provide standard alternator output of 180 amps, with available dual alternators on the 6.4L HEMI V8 ramping up max output to an

indispensable 380 amps—and a best-in-class¹² available max 440 amps with the Cummins® Turbo Diesel. Supply the Electronic Stability Control (ESC)¹¹ system as standard. Top it off with the best-in-class, largest-in-segment available 8.4-inch full-color touchscreen radio display screen.¹² To no surprise...there's still more.



LOAD IT UP. YOU'RE GETTING REMARKABLE 50,000-PSI REAR FRAME STEEL STRENGTH AT YOUR SERVICE. The conventional choice used to be either payload or towing. Not with this Ram. With up to 14K* GVWR on Dually models (and 10K - 12K on SRW models), you're now factoring in up to 31,000-lb* GCWR figures to do the job. Which is why you'll take advantage of this maximum trailering capability—yet one more area of best-in-class³ superiority. With the 6.4L HEMI V8, you can trailer up to 17,920 lb.* With the available 6.7L Cummins Turbo Diesel, up to 23,770 lb.* Front GAWRs are just as capable: with the HEMI V8, it's up to 5,500 lb.* Opt for the Cummins, and it's unsurpassed¹²—up to 6,000 lb.*

RAM 3500 CHASSIS CAB 10K GVWR MODEL AND THE 10K D.O.T.-COMPLIANT GVWR. It's what the market wants: a business-friendly Ram 3500 Chassis Cab 10K GVWR model that eliminates some D.O.T. requirements. Ram delivers with this available package.

SUSPENSIONS AND BRAKES: THIS IS THE TOTAL PACKAGE.

On Ram 3500 Chassis Cab 4x4 models, the front axle disconnect provides impressive, and often required, capability on the job. All models employ an ultra-tough heavy-duty front suspension (axle shown here). Handling and road manners are outstanding, while further advantages—like the huge 14-inch brake rotors—give these workers unimpeachable clout.

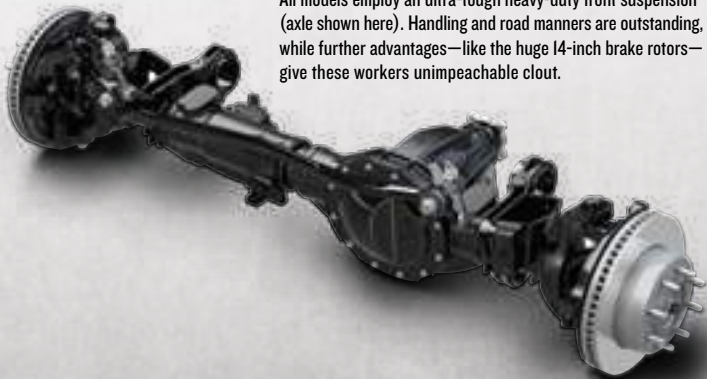

RAM 3500 CHASSIS CAB

MAX GVWR: 14,000 LB* • MAX GCWR: 31,000 LB*

Best-in-class¹² diesel oil change intervals—up to 15,000 miles
 Best-in-class¹² available dual fuel tank capacity—74 gallons
 Available PTO with the 6.4-liter HEMI V8
 "Smart" diesel exhaust brake is included with available 6.7L Cummins Turbo
 Class-exclusive¹² available 6-speed manual transmission



*When properly equipped. Properly secure all cargo.



**AMERICA'S
LONGEST-LASTING
PICKUPS¹**

**RAM HEAVY DUTY. EXERCISE
SOME MAJOR PULL IN LIFE.**



BEST-IN-CLASS¹⁴ GAS HORSEPOWER | CLASS-EXCLUSIVE¹⁴ AVAILABLE REAR AIR SUSPENSION | HIGHEST SNOW PLOW RATINGS¹⁴ | CLASS-EXCLUSIVE¹⁴ RAM ACTIVE AIR[®] | CLASS-EXCLUSIVE¹⁴ "SMART" DIESEL EXHAUST BRAKE

▶ YOU EXPECT TOP-TIER CAPABILITY. RAM HEAVY DUTY IS KEY.

From the severe demands that only Ram Power Wagon[®] can fulfill—it is, after all, the most capable off-road full-size pickup¹⁵—to the daily towing requirements of industry and agriculture, Ram Heavy Duty 2500/3500 are ready for it all. Count on exceptional numbers for payload and towing, outstanding suspension options, superior snowplow ratings—and that's just the start. **MORE ON PG 11**

AWESOME DIESEL TOWING



**RAM 3500:
UP TO 31,210 LB***

Equip a 2017 Ram 3500 with the jaw-dropping strength of the 6.7L Cummins[®] High Output Turbo Diesel, and you're fast approaching 16 tons of pure towing capability. That's Ram strength at work.

SUPERB GAS TOWING

**RAM 3500:
UP TO 16,370 LB***

When your towing needs are met only with gas power and heavy-duty 3500-class capability, Ram is ready: the 6.4L HEMI[®] V8 in Ram 3500 delivers more than 8 tons of on-demand pulling strength.



BEST-IN-CLASS¹⁶ GAS TOWING

**RAM 2500:
UP TO 16,320 LB***

What works for Ram is providing exceptional strength that doesn't necessitate exorbitant costs. A Ram Heavy Duty 2500 powered by the available 6.4L HEMI V8 gives you top-tier gas towing.



*When properly equipped. Properly secure all cargo.



RAM HD: UP TO 7,390-LB MAX PAYLOAD*

CLASS-EXCLUSIVE¹³ STANDARD FIVE-LINK COIL SPRING REAR SUSPENSION (2500) | CLASS-EXCLUSIVE¹⁴ AVAILABLE AUTO-LEVEL | REAR AIR SUSPENSION SYSTEM | UNSURPASSED¹⁵ POWERTRAIN WARRANTY | CLASS-EXCLUSIVE¹⁶ MANUAL TRANSMISSION

AUTO-LEVEL. LOAD IT UP—AND RIDE ON AIR.

► **YOU'RE LOOKING AT HUGE PAYLOADS. LET US LEVEL WITH YOU.**

Only Ram Heavy Duty 2500 comes to work with the ultra-tough and class-exclusive¹⁴ five-link coil spring rear suspension, while Ram 3500 stands out with a robust standard Hotchkiss leaf spring rear suspension. And only Ram Heavy Duty 2500/3500 offer an available Auto-Level Rear Air Suspension System with its dual modes addressing both payload and towing.

SEE MORE ON PG 11



RAM 2500/3500 PICKUP

2017 RAM HEAVY DUTY. MEETING THE TOUGHEST TASKS WITH EFFICIENCY, INNOVATION AND ROBUST CAPABILITY.



The 2017 Ram Heavy Duty 2500/3500 models prove themselves with the ideal resumé of experience and capability. These job applicants are ready to provide decades of and tens of thousands of miles of unyielding support. There's no doubt whatsoever who rules the jobsite when Ram Heavy Duty is in charge.

The executive summary: available 6.4-liter HEMI® V8 with its Multi-Displacement System helping boost fuel efficiency. Available 6.7-liter Cummins® High Output Turbo Diesel with its stunning 900 lb-ft of torque on 3500. Standard Electronic Stability Control (ESC)¹¹ system. Automatic transmissions with Electronic Range Select and the Tow/Haul Mode. Tough frames, innovative suspensions and impressive GVWRs.

THE HIGH-STRENGTH STEEL FRAME: TOUGH ENOUGH FOR TOWING AND HAULING, QUIET ENOUGH FOR COMFORT.

An expanded and durable ladder frame also features a pumped-up front suspension crossmember, hydroformed front and rear sections, and roll-formed center rail sections in an outwardly curved position that helps improve rear spring and shock placement.

The Ram Heavy Duty frames completely measure up, with 50,000-psi steel strength and eight tough crossmembers contributing to an anticipated lifetime of towing and hauling. The hydroformed front and rear sections supply durability and mass efficiencies, while the rail contours are ideally placed for ancillary mounts.

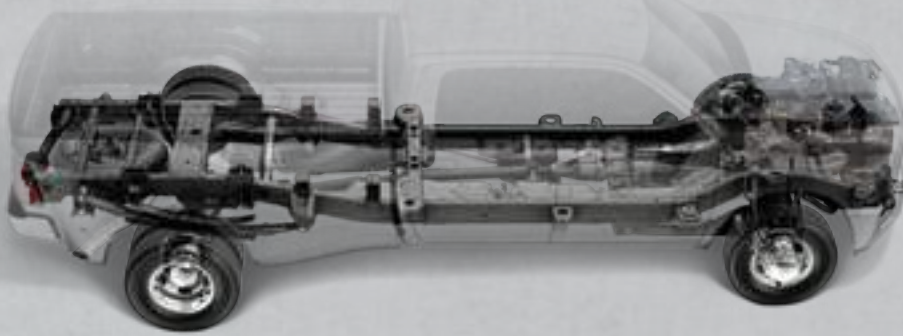

In 2017 Ram Heavy Duty 2500/3500 4x4 models, the front axle disconnect technology is all about capability and convenience. The system automatically disengages the front drive axle when reengaging the two-wheel-drive mode. The engineering helps reduce parasitic losses, and contributes to improved fuel efficiency.

Every Ram Heavy Duty model features a unique three-link front suspension—a suspension that further stands out by employing a large stabilizer bar. The bar specifically addresses the needed roll stiffness required by these impressive GVW ratings—up to 10,000 lb* for Ram 2500 and up to 14,000 lb* for Ram 3500.

FOUR REAR SUSPENSIONS: ALL ENGINEERED WITH ADVANTAGES FOR THE WEIGHT CLASS AND THE JOB AT HAND.



2500: THE FIVE-LINK COIL SPRING REAR SUSPENSION.¹⁴ Standard on Ram 2500 models is the five-link coil spring rear suspension, an ingenious design that revolutionized the heavy-duty pickup segment. Engineered to spec, it ensures superb ride/handling characteristics with ultra-dependable hauling and payload capability, even under the heaviest of loads.



2500: THE AVAILABLE AUTO-LEVEL REAR AIR SUSPENSION SYSTEM.¹⁴ This adaptation of the Air Suspension System is engineered specifically for the higher GVWRs and GCWRs of the 2500 class. Two distinctive modes are at work: Normal Load-Leveling Mode ensures a level load profile; Alternate Ride Height Mode maintains an even alignment between the trailer hitch and the trailer tongue.



3500: THE STANDARD HOTCHKISS LEAF SPRING REAR SUSPENSION. Long proven on the unbending 3500-class workhorses of the Ram Commercial family, the Hotchkiss leaf spring rear suspension ably meets the many requirements for payload capability and occupant comfort. With engineering calibrated for heavy-duty performance, your Ram 3500 pickup will deliver with jaw-dropping ability.



3500: THE AVAILABLE AUTO-LEVEL REAR AIR SUSPENSION SYSTEM.¹⁴ In this configuration, the leaf springs are augmented with air springs—but here, they're mounted on top of the axle; the engineering enables the air springs and leaf springs to seamlessly work together for superb load-carrying capability. The technology is utilized on Ram 3500 single-rear-wheel and dual-rear-wheel models.

RAM 2500 PICKUP

MAX GVWR: 10,000 LB* • MAX GCWR: 25,300 LB*



- Best-in-class¹⁶ gas-powered towing—up to 16,320 lb*
- Best-in-class¹⁴ gas horsepower—410 hp
- Best-in-class¹⁴ diesel oil change intervals—up to 15,000 miles
- Diesel-powered towing—up to 17,980 lb*
- Outstanding GCWR—up to 25,300 lb*

Ram pickups are fully compliant with SAE J2807 towing standard

*When properly equipped.

RAM 3500 PICKUP

MAX GVWR: 14,000 LB* • MAX GCWR: 39,100 LB*



- Best-in-class¹⁴ highest snowplow rating—1,265 lb*
- Best-in-class¹⁴ gas horsepower—410 hp
- Best-in-class¹⁴ diesel oil change intervals—up to 15,000 miles
- Diesel-powered towing—up to 31,210 lb*
- Gas-powered towing—up to 16,520 lb*
- Tough payload rating—up to 7,390 lb*
- Remarkable diesel torque—up to 900 lb-ft

Ram pickups are fully compliant with SAE J2807 towing standard

— AMERICA'S — LONGEST-LASTING — PICKUPS. —



Cummins

TURBO DIESEL

UP TO 385 HP/900 LB-FT TORQUE

The Ram powertrain arsenal reaches its peak with the available 6.7L Cummins® High Output Turbo Diesel in a Ram 3500 DRW pickup. With up to 900 lb-ft of torque, you're looking at sheer capability: towing up to 31,210 lb,* and payloads up to 6,580 lb.*

That's Ram and Cummins at work.

*When properly equipped. Properly secure all cargo.

RAM HD NEVER BACKS DOWN.

31,210-LB DIESEL TOWING* | 900 LB-FT DIESEL TORQUE | 7,390-LB GAS PAYLOAD*



TRAILER-TOWING MIRRORS. By design, these trucks are born and bred to pull and haul. Huge available 7 x 11-inch trailer-towing mirrors with a power-folding feature make your Ram Heavy Duty a command and control center for towing.

DRIVER INFORMATION DISPLAY. Go—and tow—in the know: the full-color high-resolution screens in select Ram models feature dozens of graphics, conveying real-time data on virtually every mechanical function.

FRAME-MOUNTED GOOSENECK HITCH ASSEMBLY. Available from Mopar®, with easy ball removal for fast flatbed conversion. Optional Fifth-Wheel/Gooseneck Prep Package includes in-bed 7-pin connector. (Ball not included in Package.)



AVAILABLE MOPAR® FIFTH-WHEEL HITCH enables super-tough trailer towing with authority. Options include a hitch with sliding rails or one that slides directly into the optional Fifth-Wheel/Gooseneck Prep Package mounts, saving time and effort.

THE RAM VIEW OF HAULING AND TOWING: CONFIDENCE AND CONVENIENCE. Don't bother to look back to the old days. Today, Ram 2500/3500 stand out by offering an available Cargo-View Camera¹⁰ that provides an on-screen display of the cargo bed. It's ideal for gooseneck or fifth-wheel hookups—and it gets better. Add the available ParkView® Rear Back-Up Camera¹⁰ to ease conventional trailer hookups, and you're adding more capability: you can toggle between the two views on the available 8.4-inch touchscreen.



SAFETY AND SECURITY TECHNOLOGY FOR EVERY ROAD.

▶ **Side-Impact Door Beams**
Designed with forgiveness in mind, these door beams are engineered to absorb impact force from every angle.

▶ **Rain-Sensitive Windshield Wipers**—Available

▶ **Dynamic Front Crumple Zones**
These crumple zones are engineered to bear the worst of any impact, helping keep cab passengers safe and secure.

▶ **ParkSense Front and Rear Park Assist**¹⁹—Available

▶ **Rain Brake Support**

▶ **Hydraulic Boost Compensation**

▶ **Antilock Brake System (ABS)**

▶ **Ready Alert Braking**

▶ **Hill Start Assist**

▶ **Auto High-Beam Headlamp Control**—Available

▶ **Electronic Brake-Force Distribution**

▶ **Antispin Rear Differential**—Available

▶ **All-Speed Traction Control**

▶ **Trailer Sway Damping**¹¹

▶ **Uconnect[®] and SiriusXM[®] Travel Link**¹⁷
keep you in the know, with detailed weather maps and info on traffic delays and road dangers—Available

In a 2017 Ram pickup, road manners join comfort and capability to ride hand in hand with safety and security. Standard on every model, the Electronic Stability Control (ESC)¹¹ system is indispensable, employing a wealth of technological advantages to keep things right. Assets include:

- ▶ **All-Speed Traction Control** helps regulate wheelspin. If slippage occurs during acceleration, automatic throttle control will reduce torque; in extremes (like accelerating from pavement to ice), it will apply the brakes and reduce the engine power to help maintain control.
- ▶ **Trailer Sway Damping**¹¹ detects yaw and applies selective brake pressure on the tow vehicle's opposite side to counteract and reduce the sway.

The Ram braking system features optimized pedal travel to provide quick power assist. Rear wheel-speed sensors are positioned for protection against road elements. ESC¹¹ features multiple assets for braking; it even includes vehicle control when stationary. These encompass:

- ▶ **Antilock Brake System (ABS)**. Monitoring each wheel's speed, the ABS design also incorporates back-up braking should one of the two braking circuits be compromised.
- ▶ **Electronic Brake-Force Distribution** regulates brake pressure from front to rear to minimize stopping distances.
- ▶ **Ready Alert Braking** senses the moment when the driver's foot is lifted from the accelerator; it applies an imperceptible brake force to ensure that pads and discs are lined up should an emergency stop be required.
- ▶ **Rain Brake Support** automatically and seamlessly activates when the driver turns on the windshield wipers; all brake calipers gently pulse against their respective rotors to remove water from the pads.
- ▶ **Hydraulic Boost Compensation**. Should a failure occur in the vacuum brake booster or any related line (e.g., a rupture from tough off-roading), the brake controller will run the ABS pump; our system is so sophisticated, it conveys the problem to the driver. Most important, the brakes perform as normal until the failure is serviced.
- ▶ **Hill Start Assist**. When the vehicle is angled on hills or inclines, Hill Start Assist keeps your Ram pickup stationary for two seconds after the brakes have been released or until the accelerator is depressed.

Available ParkSense[®] Front and Rear Park Assist System¹⁹ Integrated sensors use ultrasonic waves to detect objects as far as 47 inches from the bumpers. Read-outs in the gauge cluster/display along with audible chimes help notify the driver of proximity to front and/or rear objects.



DRIVER INFORMATION DISPLAY

Your Ram pickup is a rolling powerhouse of knowledge, instant information and state-of-the-art communications technologies. And it's all in your command, with the available and customizable full-color seven-inch Driver Information Display with some 34 menu options, including detailed graphics that convey real-time vehicle information.

Select models inform you with a six-ring instrumentation cluster, and you can always move up to the largest available 8.4-inch radio touchscreen.^{6,15} Add truly awesome leading-edge telematics available through Uconnect, and you've got it all: tunes, info, web content,¹⁸ vehicle control and instant data.



TECHNOLOGY: ELEGANTLY AND POWERFULLY SIMPLE.

Uconnect
EVERYTHING YOU NEED TO STAY CONNECTED.



DISCOVER NEW PLACES

AT HOME OR ON THE ROAD, FIND THE BEST RESTAURANTS, SHOPPING AND ENTERTAINMENT VENUES WITH A QUICK SEARCH.
*Certain features not available while vehicle is in motion.



START YOUR RAM FROM AFAR

WARM UP THE ENGINE AND CABIN, UNLOCK YOUR DOORS OR FLASH YOUR HEADLAMPS—JUST BY USING YOUR PHONE!¹



CUSTOMIZE WITH DRAG AND DROP

SELECT FROM A MENU OF APPS AND DRAG YOUR CHOICES INTO PLACE ALONG THE BOTTOM ROW FOR EASY CUSTOMIZATION.

CALL 9-1-1

ASSIST IN EMERGENCIES

IT'S INVALUABLE AND POTENTIALLY LIFE-**SAVING**. ACCESS 9-1-1 CALL¹⁶ OR **ROADSIDE ASSISTANCE**¹⁷ WITH THE TOUCH OF A BUTTON.



HOST A HOTSPOT

UPLOAD AND DOWNLOAD, POST AND SEARCH. **UCONNECT**¹⁸ WITH AVAILABLE **WI-FI HOTSPOT**¹⁹ LETS YOU **CONNECT** YOUR DEVICES DIRECTLY TO THE WEB.
¹⁸Additional charges apply.



NAVIGATE YOUR ADVENTURES

ENTER DESTINATIONS WITH JUST YOUR VOICE AND GET **TURN-BY-TURN AUDIO DIRECTIONS**. IT'S THE **SMARTEST ROUTE** TO ANY **DESTINATION—ON- OR OFF-ROAD**.



LISTEN TO MUSIC, TALK SHOWS AND SPORTS

KEEP THINGS MOVING WITH THE BEST VARIETY OF ENTERTAINMENT ON THE ROAD. YOU CAN SCREAM ABOUT SPORTS, TALK BACK TO TALK RADIO, CHUCKLE AT YOUR FAVORITE COMIC AND SOUND OFF ABOUT THE NEWS.

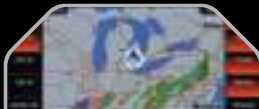

WEATHER ON DEMAND

WHETHER YOU'RE TRAVELING ACROSS TOWN OR ACROSS THE COUNTRY, PULLING UP THE MOST RECENT WEATHER REPORT GIVES YOU INSTANT INFO ABOUT WHAT NATURE HAS IN STORE.



SPEAK UP AND BE HEARD

SIRI²⁰ EYES FREE²¹ RESPONDS TO YOUR VOICE²². MAKING FOR A CONVENIENT WAY TO SAFELY AND EASILY CONTROL YOUR IPHONE.²³

SiriusXM[®] TRAVEL LINK[®]

SEE INTO THE FUTURE

TAKE ADVANTAGE OF WEATHER AND TRAFFIC REPORTS WITH A FIVE-YEAR TRIAL SUBSCRIPTION²⁴ TO SIRIUSXM[®] TRAVEL LINK[®] AND SIRIUSXM TRAFFIC!²⁵

²⁴Available on select Uconnect systems. See dealer for details.



KNOW THE ROAD

KEEP INFORMED ABOUT WHAT LIES AHEAD, FROM TRAFFIC TO ROAD CONDITIONS AND DELAYS—AND EVEN POSSIBLE DANGERS.

FOR 1500 AND HD: RAMBOX[®] CARGO MANAGEMENT SYSTEM. ^{6,14}



ACCOMMODATES
STANDARD 4x8 SHEETS
OF BUILDING MATERIALS

← 48.1" BETWEEN BED WALLS →

5'7" BED: 91.5" LENGTH,
FRONT OF BOX TO END OF
OPEN TAILGATE

6'4" BED: 100.2" LENGTH,
FRONT OF BOX TO END OF
OPEN TAILGATE



REMOTE KEYLESS ENTRY WITH THE ALLSECURE[®] LOCKING SYSTEM. Versatile key fobs control another invaluable advantage: the available Remote Keyless Entry System with the AllSecure Locking System, which locks/unlocks all doors, the tailgate and (if equipped) both RamBox System bed-side compartments. Available fob functions also include control of the Remote Start, the panic button and even the Entry/Exit Mode of the available Active-Level[™] Four-Corner Air Suspension System for Ram 1500.



ADD ON STORAGE

THE RAMBOX® SYSTEM SIDE CARGO BINS are lockable, illuminated and feature drain plugs that enable refrigeration by ice. They're made even more capable through multiple available Accessories from Mopar® that perfectly fit within the compartments.



LIGHT THE BED

CONVENIENT IN-BED LED ILLUMINATION augments the CHMSL-mounted overhead rear light, allowing generous latitude when loading/unloading at night. An added convenience: if you've got a tonneau cover, you won't need to adjust it at all.

DIVIDE & CONQUER

THE CARGO BED EXTENDER/DIVIDER doesn't merely let you arrange cargo. Extend it over the open tailgate to enclose larger cargo. When not in use, the thin profile component is stored at the front of the bed, just behind the passenger cabin.

KEEP IT TIGHT

CARGO RAILS WITH ADJUSTABLE TIE-DOWN CLEATS let you secure cargo—and the rails are multi-purpose. Like the side bins, they expand convenience and capability by accommodating many Authentic Accessories from Mopar.



RAM 1500 PICKUP

RAM LEADERSHIP: COMMANDING ENGINES AND TRANSMISSIONS. INNOVATIVE, RESILIENT SUSPENSIONS. BEST-IN-CLASS³ 29 MPG HIGHWAY* FROM THE GROUNDBREAKING AVAILABLE 3.0L ECODIESEL V6[†]



Ram 1500 pioneered the available and class-exclusive⁶ Active-Level™ Four-Corner Air Suspension System along with the equally innovative, class-exclusive⁶ standard multilink coil spring rear suspension. Power is just as impressive, encompassing the available 3.0L EcoDiesel V6[†] (with its 29 mpg hwy* and 420 lb-ft of torque) and the available legendary 5.7L HEMI® V8 powerhouse.



SIX PACK ON DEMAND. Ram Laramie, with its Light Frost Beige, leather-trimmed interior, seats six with space, luxury and refinement.

A quick look at the Laramie® and Limited trim levels—think leather trim, and lots of it—is fast proof that this full-size pickup is the go-to truck for comfort and convenience.

ACTIVE-LEVEL: AUTOMATIC BENEFITS FOR PAYLOAD.

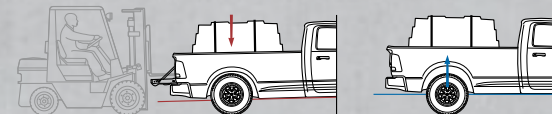

ACTIVE-LEVEL SUSPENSION: Pioneered by Ram 1500, this available and class-exclusive⁶ asset solidifies Ram 1500 leadership. Augmenting the available four-corner air suspension system (with its five distinct modes of operation), Active-Level suspension engineering equalizes Ram 1500 under heavy payloads. This degree of payload control offers a wealth of benefits, including correct fore-and-aft vehicle balance; a constant horizontal load plane; an even and level driving profile; and a consistent headlamp-to-road angle for vision-friendly forward illumination. It's controlled by the switchbank, shown below. The benefits of the technology while trailering appear on the following page.

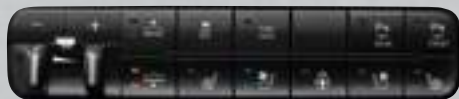

FINGERTIP CONTROL THROUGH THE INTEGRATED SWITCHBANK. Operate the available Active-Level Four-Corner Air Suspension System—and more. The switches let you move from mode to mode, ensuring the ideal ride height for terrain and conditions. Depending on the options you choose, the other buttons can control a variety of standard and available features; among them: the available Electronic Trailer Brake Controller, the Electronic Stability Control (ESC)¹¹ system, the Tow/Haul Mode, seat heat and ventilation, the heated steering wheel and more.



Properly secure all cargo.

A CONCISE, 5-POINT BUSINESS PLAN FOR TOWING.

- Count on structural rear bumpers rated for Class III towing, and easily handle trailers up to 5,000 lb[‡]
- Use the available factory-installed Class IV hitch receiver, which is bolted directly to the frame. It multiplies towing capacity—up to 10,620 lb[‡]
- Note the standard 4- and 7-pin trailer connectors that enable instant trailer hook-ups, and eliminate tedious junctions and adapters when you need to utilize multiple types of trailers.
- Consider the increased use of stronger and more resilient yet lighter steel; it helps contribute to the Ram 1500 tradition of fuel-sipping performance. This high-strength steel frame is engineered with low-torsion dynamics and accompanies fully boxed side rails. The engineering strengthens the whole package—including the Ram 1500 reputation for minimal noise, vibration and harshness (NVH).
- Factor in the available Active Grille Shutters; they instantly adapt to speed, load and engine needs to provide ideal engine cooling, reducing aerodynamic drag and helping improve fuel efficiency.



29 MPG HWY^{3*}

THE 3.0L ECODIESEL V6[†] THEY NEVER SAW IT COMING.

With 420 lb-ft of torque, outstanding fuel efficiency, and exceptional driving range (up to 754 miles** on a single tank), there's little wonder why this engine has taken the world by storm—reflected in rave reviews and unprecedented demand.



THE TORQUEFLITE® 8-SPEED AUTOMATIC. STANDARD ON RAM 1500.

The objective: provide outstanding shift qualities and impeccable performance from cruising to hauling—while contributing to the superb Ram 1500 fuel efficiency. The TorqueFlite 8-speed does it all, utilizing steering wheel-mounted buttons for manual gear range selection for more control. Standard with the Pentastar® V6, EcoDiesel V6[†]; and 5.7L HEMI V8.



RAM 1500 PICKUP

MAX GVWR: 6,950 LB[‡] • MAX GCWR: 15,950 LB[‡]



Class-exclusive⁶ available Active-Level Four-Corner Air Suspension System

Best-in-class⁶ available RamBox® Cargo Management System

Best fuel economy of any full-size pickup³—up to 29 mpg highway* (EcoDiesel HFE)



Capability: up to 10,620-lb towing[‡] (HEMI V8); up to 9,210-lb towing[‡] (EcoDiesel V6[†])

Standard Class IV hitch receiver (Tradesman®)

*Manufacturer's estimated 29 mpg hwy based on Ram 1500 EcoDiesel HFE 4x2. Actual results may vary. †Late availability. ‡When properly equipped. **Manufacturer's estimated 29 mpg hwy based on Ram 1500 EcoDiesel HFE 4x2 and 26-gallon fuel tank. Actual results may vary.

**AMERICA'S
LONGEST-LASTING
PICKUPS.**



RAM 1500: 10,620-LB MAX TOW*—AND MORE.



ELIMINATE LIFE'S UPS AND DOWNS. Give your Ram 1500 major clout. The class-exclusive⁶ available Active-Level™ Four-Corner Air Suspension System delivers five modes of operation. Crucially, it makes trailering a breeze, simplifying ball/hitch alignment. The bigger picture? The system counteracts weight from trailering/hauling, maintains an even and level profile when loaded, and keeps constant the rake from the front end to the rear of the trailer.

SUSPENSION MANAGEMENT is at your fingertips. The dash-mounted integrated switchbank lets you raise or lower the vehicle with the available Active-Level Four-Corner Air Suspension System, and also enables adjustments of the trailer brake gain while towing.

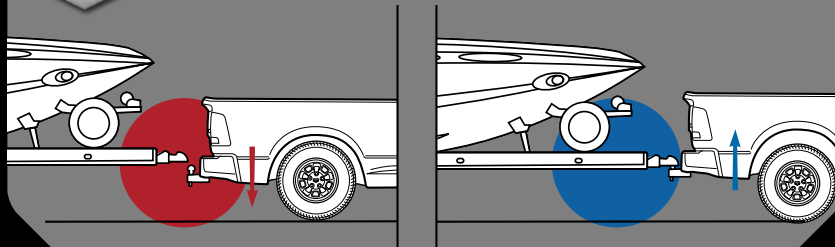

STAY AHEAD OF THE GAME. LOOK BACK. Make towing a cinch. The available ParkView® Rear Back-Up Camera¹⁰ with Active Grid Lines is a natural for aligning the trailer ball with the hitch.

DOZENS OF MENU OPTIONS include data about the available trailer brake controller. This reading signals that the brake is at 50% of total operation with a 3.5% gain. You'll control the gain that's right for the terrain with the center stack-mounted trailer brake controller.

COVER EVERY ANGLE. Monitoring your trailer is critical. Extra-wide available trailer-towing mirrors on each side are the answer. Measuring a substantial 7 x 11 inches, they offer a maximum view, with a wide-angle mirror for peripheral traffic.



*When properly equipped. Properly secure all cargo.

WE RAISED THE BAR. AND HELPED LOWER THE COST OF OWNERSHIP.



AWARD-WINNING 3.6L PENTASTAR® V6: BEST-IN-CLASS⁴ STANDARD V6 HORSEPOWER | CLASS-EXCLUSIVE⁵ FRONT-WHEEL DRIVE | BEST-IN-CLASS⁶ TURNING DIAMETER* | BEST-IN-CLASS⁴ LOWEST LOAD FLOOR HEIGHT

4,430 LB OF PAYLOAD STRENGTH.†

▶ **RAM PROMASTER.® IT'S DESIGNED FOR ONE PURPOSE: CHANGE.**

The single mandate to the design team? Make it versatile. They accomplished the assignment with flying colors. Ram ProMaster is a vehicle custom-made for, well, customization. You've got dozens of possible variations on one theme: to personalize it, and make your business go—and grow. [DETAILS ON NEXT PAGE](#)

*Short-wheelbase model. †When properly equipped.

RAM PROMASTER[®]

WHERE VERSATILITY AND SPACIOUSNESS CREATE AN UPFIT-FRIENDLY WORKER READY TO LEAD.



Smart business management employs muscle and genius—the very credentials for a 2017 Ram ProMaster, with four cab/body styles (Cargo and Windowed Vans, Chassis Cabs and Cutaways), multiple wheelbases, an available extended floor for the 159-inch wheelbase models, and two roofs (including the High Roof option for Cargo Van, giving 6'3" workers plenty of standing room). Power comes from the award-winning 3.6L Pentastar[®] V6. Class-exclusive⁴ front-wheel drive is standard across the board, and quality is top-tier: the many best-in-class⁴ features for ProMaster Cargo Van include the lowest load floor height, the greatest width between rear wheel wells, the best standard interior cargo height and best standard V6 horsepower—thanks to the robust and proven Pentastar V6.

LOOKS LIKE A WORKER. ACTS LIKE A LEADER. GO CONFIGURE THAT ONE OUT.

Outfit your Ram ProMaster with two available assets that are invaluable when maneuvering or dealing with loading docks. The ParkView[®] Rear Back-Up Camera¹⁰ (with grid lines displayed on the screen) is high-mounted; its strategic placement lets you back up to loading docks with the rear doors open. The ParkSense[®] Rear Park Assist¹⁰ utilizes ultrasonic sensors discreetly integrated into the rear bumper to audibly warn the driver of rear obstructions.

Critical to road manners, handling and performance is the comprehensive Electronic Stability Control (ESC)¹¹ system, which includes ABS, a Brake/Lock Differential, All-Speed Traction Control, Brake Assist, Engine Drag Control, Trailer Sway Damping¹¹ Hill Start Assist and Rollover Mitigation.

Cutaway and Chassis Cab models complement Ram Commercial by augmenting customization and upfit capability. These cab-forward front-wheel-drive powerhouses are the go-to design of choice when you need low step-in heights and/or easy access by ramps. The 24.4-inch top-of-frame-to-ground design is a welcome asset if your business deals with dolly-reliant delivery of oversized items, or large landscaping equipment.



On ProMaster Cargo Van models, roof strength weighs in with a 330-lb rating. We employ six roof rail mounts, three on each side. And all exposed body panels on every model are galvanized for long-term corrosion protection.

The front-wheel-drive configuration utilizes a telescoping steering column that controls crisp rack and pinion hydraulic steering, for a firm, responsive and confident feel.

36.3-FOOT
CURB-TO-CURB
TURNING

A premium steering gear enhances drive quality and reliability, and helps contribute to an incredibly tight turning diameter: the tiny 36.3-foot diameter on the short-wheelbase models is yet another best-in-class⁴ advantage.

The body-frame integral design meets the need, delivering the strength you demand. On ProMaster Van models, a steel framework works with integrally welded components; these include crossrails, longitudinal rails, the floor pan and the side panels.

Brakes are on the performance level: Brembo[®] four-wheel disc; the front rotor diameter is an impressive 11.8 inches. The proven MacPherson strut front suspension features huge 62-mm twin-tube shocks for outstanding support of cargo. GVW-tuned cast-iron control arms offer notable durability.



From the first concept to completion, this interior was designed to be a benchmark for the industry. Ram ProMaster advantages give you and your upfitter enormous latitude.

Here, huge flat load floors support everything from multiple refrigerator- and stove-size boxes to future in-vehicle work benches for a mobile work station. Near-vertical side walls permit extensive shelving—and their presence hardly impacts the standard cubic foot measurements for that vast interior volume. Given three wheelbase measurements (and an extended floor design that adds further capacity to the 159-inch wheelbase), two roof heights and two available partitions, you can transform your Ram ProMaster model into a model of efficiency and capability.

RAM PROMASTER

MAX GCWR: 11,500 LB*
MAX TOWING: 5,100 LB* • MAX PAYLOAD: 4,430 LB*



Best-in-class⁴ turning diameter (118-inch wheelbase)
Best-in-class⁴ lowest load floor height
Best-in-class⁴ standard V6 horsepower—280 hp,
with 260 lb-ft of torque
Class-exclusive⁴ front-wheel drive (FWD)

*When properly equipped. Properly secure all cargo.



HIGH ROOF
462.8
MAX CUBIC FEET†

STANDARD ROOF
303.7
MAX CUBIC FEET†

†Max cargo volume;
meets SAE J1100 requirements.

RAM PROMASTER CITY. HUGE RESIDUAL VALUE IS JUST THE START.



BEST-IN-CLASS⁵ HIGHWAY FUEL ECONOMY | BEST-IN-CLASS⁵ CARGO CAPACITY—UP TO 131.7 CU FT | BEST-IN-CLASS⁵ PAYLOAD | BEST-IN-CLASS⁵ HORSEPOWER AND TORQUE | UNSURPASSED⁶ TOWING*—UP TO 2,000 LB



28 MPG HWY^{5†} 2.4L TIGERSHARK[®] MULTIAIR² I-4

▶ **MEET THE 2017 COMMERCIAL GREEN CAR OF THE YEAR™—AND FOR THE SECOND CONSECUTIVE YEAR.** The built-in advantages of this urban-friendly design just keep growing. This is the first-ever instance of receiving the coveted Commercial Green Car of the Year from *Green Car Journal* two times in a row. And since we know higher residual value means more for your bottom line, take comfort and pride in the fact that Ram ProMaster City retains its value better than Ford, Chevy and Nissan in its segment.²⁵
FOR MORE, TURN THE PAGE



Ram ProMaster City retains its value better than Ford, Chevy and Nissan in its segment.²⁵

*When properly equipped. †EPA estimated 21 mpg city/28 mpg hwy. Actual results may vary.

RAM PROMASTER CITY[®]

**RAM PROMASTER CITY CARGO VAN AND PASSENGER WAGON:
IT'S WHERE EFFICIENCY AND BOTTOM-LINE VALUE WORK HAND-IN-HAND.**



Ram ProMaster City: where you count both advantages and built-in value to bolster your bottom line. Aerodynamic, spacious and versatile, Ram ProMaster City models are built on a 122.4-inch wheelbase, with a total length of 15.6 feet; think typical mid-size sedan. It's a layout that translates into generous passenger room and, on Cargo Van, best-in-class⁵ cargo capacity. When you factor in the outstanding residual value, this very green vehicle becomes an indispensable business partner.

alg Ram ProMaster City retains its value better than Ford, Chevy and Nissan in its segment.²⁵

The robust 2.4L Tigershark[®] with MultiAir[®]2 is mated to the class-exclusive⁵ nine-speed automatic, churning out a best-in-class⁵ 178 horsepower and 174 lb-ft of torque and best-in-class⁵ 28 mpg highway.* With unsurpassed⁵ towing (up to 2,000 lb[†]) and best-in-class⁵ driving range with standard motor (up to 448 miles[‡]) on a tank of 87-octane regular, ProMaster City is a working model of efficiency.



RAM PROMASTER CITY TRADESMAN[®] CARGO VAN. Best-in-class⁵ payload works with vertically oriented side walls and a completely flat load floor; interior space is enormous; latitude for customization enables a wide variety of upfits. Configuration is just as efficient: rear 60/40 doors deliver 90°- and 180°- openings, rear lift-in height is a worker-friendly 23.3 inches, and all interiors feature tie-down rings. It's an overall design ready-made for countless functions—including aftermarket Automobility applications.



A CAVERNOUS INTERIOR OFFERS ROOM TO MOVE—AND GROW. Tradesman Cargo Van brings you best-in-class⁵ cargo capacity: 131.7 cubic feet. In ProMaster City Passenger Wagon, those numbers transform into welcome and generous room for up to five occupants. The convenient side-door step-in height of 19.3 inches (Wagon model), 60/40 split rear cargo doors and super-wide dual sliding side doors deliver easy access for people and comfortable handling of cargo.

ROOF WEIGHT CAPACITY

150 LB*



A	CARGO AREA HEIGHT	51.8"
B	CARGO AREA WIDTH	60.4"
C	CARGO WIDTH BETWEEN WHEEL WELLS ⁵	48.4"
D	CARGO AREA LENGTH	87.2"
E	REAR LIFT-IN HEIGHT	23.3"

LET'S PUT THIS REAR VIEW INTO PERSPECTIVE. The front-seat-only configuration of the ProMaster City Cargo Van models gives you nearly infinite possibilities for an aftermarket upfit. If your business relies on making deliveries, think big: the best-in-class⁵ cargo capacity shows how easily Ram ProMaster City configures into an on-site mobile workshop.



RAM PROMASTER CITY

Best-in-class⁵ highway fuel economy

Best-in-class⁵ cargo capacity—131.7 cu ft (Cargo Van models)

Best-in-class⁵ max payload: 1,883 lb[†] (Cargo Van models)

Class-exclusive⁵ 9-speed automatic transmission

Unsurpassed⁵ max towing: 2,000 lb[†] (Cargo Van models)

Best-in-class⁵ horsepower and torque—178 hp/174 lb-ft of torque

Class-exclusive⁵ bi-link rear suspension

Best-in-class⁵ GVWR—5,395 lb



*EPA estimated 21 mpg city/28 mpg hwy. Actual results may vary. [†]When properly equipped.

[‡]EPA estimated 21 mpg city/28 mpg hwy and 16-gallon fuel tank. Actual results may vary. Properly secure all cargo.



— AMERICA'S —
MOST EFFICIENT
— WORK VAN —

ONE OF OUR BEST STRENGTHS IS A WEAKNESS FOR COMFORT.

RAM PROMASTER®: HIGH-POSITIONED SEATS AVAILABLE TWO-PASSENGER BENCH SEAT AVAILABLE HEATED SEATS AVAILABLE SWIVEL SEATS AVAILABLE AUXILIARY SWITCHES FOR FUTURE UPFITS

► **TOUGH TRUCKS—BUT WORKING IN THEM IS EASIER THAN EVER.** If there's one area that characterizes the commercial sector, it's multitasking. You're doing a dozen things at once. No surprise to find that the cabin of your Ram matches it—with comfortable seating, intelligent instrumentation, leading-edge telematics and versatile interiors that give you an office on the run—ably demonstrated in Ram ProMaster Cargo Van, above.



The Ram ProMaster® exterior is aerodynamic, sleek and functional. There are even built-in footholds in the front fascia to enable easy windshield cleaning and wiper-blade replacement. Inside, convenience rules, with soft-touch materials, standard telescoping steering column, easy-to-read instrumentation and easy-to-access controls. Storage is abundant, with oversize door pockets, triple cup holders below the center stack, and an available overhead shelf system so robust, the 2.5-liter area can actually hold up to 44 lb of materials.



YOU'RE NOW IN CHARGE OF THE DEPARTMENT OF THE INTERIOR.

RAM CHASSIS CABS AND PICKUPS: COMFORT, CONVENIENCE, CONTROL.



We think every worker deserves the respect of an internal performance review. The Ram pickups and Chassis Cabs ably illustrate that a dedicated on-the-job partner can contribute to top-tier performance and bottom-line functionality through comfort and convenience.

The facts speak for themselves—and quite eloquently. Every model and trim level in the portfolio provides exceptional amenities, storage and comfort.

In Ram pickups, the convenient under-the-seat storage built into Ram Quad Cab® and Crew Cab models provides ideal places to stash tools and valuables. Available fold-flat load floor capability in Ram Quad Cab and Crew Cab also stands out; they're completely flat, with no angled break like other trucks. On Ram Crew Cab pickups, the in-floor storage bins go beyond safely securing documents or valuables; drainable and removable, they're perfect for keeping food and beverages chilled. Finally, the fold-forward rear seating of Mega Cab® also translates into instant cargo-carrying capability.

AVAILABLE FULL-LEATHER SEATING | LEADING-EDGE TELEMATICS | ABUNDANT STORAGE SOLUTIONS | AVAILABLE SIRIUSXM® SATELLITE RADIO;⁷ WITH A ONE-YEAR TRIAL SUBSCRIPTION



Ram Big Horn® interior: premium cloth-trimmed seating for six



Ram Crew Cab pickups: available in-floor storage bins and under-the-seat storage space



Ram Quad Cab and Crew Cab: available fold-flat load floor storage

Properly secure all cargo.

RAM PROMASTER CITY® CARGO VAN AND WAGON: A COMFORTABLE CASE FOR STORAGE.



The more we design, the more we improve. And the more we improve, the more comfortable you become. The interiors of Ram ProMaster® and, shown below, Ram ProMaster City models, make the point by supplying outstanding functionality that combines with exceptional occupant comfort.

Our interior designers took some important extra steps with these models, creating seating and surrounds that plan on decades of use. Seats are

designed for day-in comfort and year-long durability; long-wearing and easy-to-clean fabrics are bolstered by creature comforts—like available premium cloth bucket seats with driver-side lumbar supports and height adjusters.

More and more, the crowning touches to virtually all Ram interiors are a focus on beyond-state-of-the-art telematics and communications. Media centers on select Ram models in the portfolio feature available satellite radio, Wi-Fi and Internet connectivity¹; touchscreens, if so equipped, are full-color and customizable.



Ram ProMaster City: front seats and instrumentation



Ram ProMaster City: multi-use glove box and storage



Ram ProMaster City: convenient standard overhead bin

A POWERTRAIN FOR EVERY JOB.

RAM GAS ENGINES

	2.4L Tigershark® I-4	3.6L Pentastar® V6	5.7L HEMI® V8	6.4L HEMI V8		
1500 Pickup	_____	Standard 305 HP 269 LB-FT TorqueFlite® 8HP45 8-Speed Auto	Available 395 HP 410 LB-FT TorqueFlite 8HP70 8-Speed Auto	_____		
2500 Pickup	_____	_____	Standard 383 HP 400 LB-FT 66RFE 6-Speed Auto	Available 410 HP 429 LB-FT 66RFE 6-Speed Auto		
3500 Pickup	_____	_____	Standard 383 HP 400 LB-FT 66RFE 6-Speed Auto	Available 410 HP 429 LB-FT 66RFE 6-Speed Auto	Available, Mega Cab® Only: 370 HP 429 LB-FT 66RFE 6-Speed Auto	
3500 Chassis Cab	_____	_____	_____	Standard, SRW 410 HP 429 LB-FT 66RFE 6-Speed Auto	Standard, DRW 370 HP 429 LB-FT 66RFE 6-Speed Auto	Available, SRW/DRW 370 HP 429 LB-FT AISIN® AS66RC 6-Speed Auto
4500 Chassis Cab	_____	_____	_____	Standard 366 HP 429 LB-FT AISIN AS66RC 6-Speed Auto		
5500 Chassis Cab	_____	_____	_____	Standard 366 HP 429 LB-FT AISIN AS66RC 6-Speed Auto		
Ram ProMaster City®	Standard 178 HP 174 LB-FT 9-Speed Auto	_____	_____	_____		
Ram ProMaster®	_____	Standard 280 HP 260 LB-FT 62TE 6-Speed Auto	_____	_____		

■ Standard configuration

2.4L TIGERSHARK MULTI-AIR® 2 I-4

EFFICIENT POWER WITH A CLASS-EXCLUSIVE⁵ NINE-SPEED AUTOMATIC.

Meet the singular and powerful four-cylinder gas powerplant in our arsenal of engines—and the ideal powerhouse for Ram ProMaster City Tradesman® Cargo Van and Passenger Wagon models.

The MultiAir2 technology—long proven in the field—features multiple engineering enhancements for combustion control, improved fuel efficiency and reduced exhaust emissions, all culminating in best-in-class⁵ horsepower and torque on Ram ProMaster City. Details on its partner—the 9-speed automatic—are on the following page.

3.6L PENTASTAR V6

INDUSTRIAL-GRADE POWER ACROSS THE BOARD.

This efficient and powerful V6 powerplant has been honored with universal acclaim and multiple awards. Count on commercial-grade reliability, top-tier performance and welcome six-cylinder efficiency.

Powering two of our flagship commercial vehicles, the 3.6L Pentastar V6 is mated with the ideal transmission for each vehicle application. Specific calibrations exclusive to the vehicle are designed to ensure the best in performance and fuel efficiency.

5.7L HEMI V8

LEGENDARY MUSCLE ACQUIRES INDUSTRIAL STRENGTH.

 The 5.7L HEMI V8 with Variable Valve Timing (VVT) is an offshoot of one of the major steps in transportation. (Former HEMI engine applications have ranged from prototype aircraft to muscle cars; this is truly an engine with a respectable heritage.) Today, the available 5.7-liter HEMI V8 with Multi-Displacement System (MDS) in a Ram 1500 pickup delivers capable and fuel-efficient performance.

Standard powertrain partners to the 5.7L HEMI V8 are the 8HP70 8-speed automatic for Ram 1500 and the 66RFE 6-speed automatic for Ram 2500/3500 HD SRW. All of our commercial-grade transmissions are detailed on the following pages.

6.4L HEMI V8

AWESOME POWER—AND MAJOR PTO SUPPORT FOR CHASSIS CABS.

 Standard on Ram Chassis Cabs and available for Heavy Duty pickups, the performance attributes of the large-displacement HEMI V8 include the invaluable Fuel Saver Technology. These stats earn their keep: the 6.4L HEMI V8 delivers up to 410 horsepower and 429 lb-ft of on-demand torque.

RAM DIESEL ENGINES

 3.0L EcoDiesel V6*	6.7L Cummins® Turbo Diesel I-6		6.7L Cummins High Output Turbo Diesel I-6
1500 Pickup	Available 240 HP 420 LB-FT TorqueFlite® 8HP70 8-Speed Auto		_____
2500 Pickup	_____	Available 350 HP 660 LB-FT G56 6-Speed Manual	Available 370 HP 800 LB-FT 68RFE 6-Speed Auto
3500 Pickup	_____	Available 350 HP 660 LB-FT G56 6-Speed Manual	Available 370 HP 800 LB-FT 68RFE 6-Speed Auto Available 385 HP 900 LB-FT AISIN® AS69RC 6-Speed Auto
3500 Chassis Cab	_____	Available 320 HP 650 LB-FT G56 6-Speed Manual	Available 325 HP 750 LB-FT AISIN AS69RC 6-Speed Auto
4500 Chassis Cab	_____	Available 320 HP 650 LB-FT G56 6-Speed Manual	Available 325 HP 750 LB-FT AISIN AS69RC 6-Speed Auto
5500 Chassis Cab	_____	Available 320 HP 650 LB-FT G56 6-Speed Manual	Available 325 HP 750 LB-FT AISIN AS69RC 6-Speed Auto

3.0L ECODIESEL V6*

GROUNDBREAKING DESIGN, STUNNING PERFORMANCE.

 The available 3.0L EcoDiesel V6* gives Ram 1500 exceptional advantages in the light-duty pickup market. The remarkable 420 lb-ft of torque translates into outstanding takeoff from a stop. The impressive driving range (up to 754 miles¹ per full tank) is exceeded by superiority: the engine delivers the best fuel economy of any full-size pickup.³

This small-displacement high-performing turbo diesel is mated to the TorqueFlite 8-speed automatic. Count on fuel-efficient performance, B20 (biodiesel) capability, 10K oil change intervals and a top-notch (and low-maintenance) Diesel Exhaust Fluid (DEF) system.

6.7L CUMMINS TURBO DIESEL

MULTIPLE ITERATIONS, INCREDIBLE TORQUE, PROVEN LONGEVITY.

 Few engines carry the industrial clout of the 6.7L Cummins Turbo Diesel. In the Ram Commercial portfolio, five specialized calibrations culminate in the available High Output version, with its work-hungry 900 lb-ft of torque for 3500 pickups. Varying Cummins iterations are available for Ram Heavy Duty pickups and Ram Chassis Cab models.

It gets better: the 6.7L Cummins High Output Turbo Diesel is mated to the formidable AISIN Heavy-Duty 6-speed automatic transmission. Put this available powertrain in a 2017 Ram 3500 Heavy Duty pickup, and you're talking tow ratings up to 31,210 lb[†]

Opting for the Cummins in your Ram of choice offers a myriad of assets: available dual alternators (in-tandem 220-amp units for a max 440 amps on Heavy Duty pickups and Chassis Cabs); an invaluable "auto idle-up" feature to automatically adjust when greater electrical power is needed; and "smart" diesel exhaust brake on all calibrations. When applied to the upfitter-friendly Ram Chassis Cabs with their specialized transmissions, Ram and Cummins benchmark PTO access and capability. The point that drives it home is proven durability. A Cummins in a Ram Heavy Duty adds up to quality the others can only envy: more than two million trucks in total have featured this work-ready combination.

¹Late availability. ²Manufacturer's estimated 29 mpg hwy based on Ram 1500 EcoDiesel HFE 4x2 and 26-gallon fuel tank. Actual results may vary. ³When properly equipped.

ACTIVE ROLES FROM SILENT PARTNERS.

RAM PROMASTER CITY® CARGO VAN AND WAGON THE CLASS-EXCLUSIVE⁵ 9-SPEED AUTOMATIC TRANSMISSION

ADVANCEMENTS IN DRIVETRAIN TECHNOLOGY. This package is technical excellence at work: the 2.4L Tigershark® I-4 with MultiAir®2 is mated to the class-exclusive⁵ 9-speed automatic; think power with enviable economy.

» **MODERN ENGINE DYNAMICS MEET HIGH-TECH TRANSMISSION ENGINEERING.** *The combination has real-world and bottom-line advantages: outstanding acceleration, performance and capability—with stellar fuel efficiency.*

RAM 2500/3500 PICKUPS, 3500 CC (GAS); RAM PROMASTER CARGO VAN THE 6-SPEED AUTOMATICS (66RFE/62TE)

BUILT-IN VERSATILITY AND CAPABILITY. Smart engineering allows us to adapt this component to specific applications. Ideal to the Heavy Duty weight class is the 66RFE, while the Ram ProMaster models use the 62TE transmission. All iterations include Electronic Range Select and multiple clutch packs. The 66RFE also features a dual-stage hydraulic pump with electronic control over three planetary gearsets to provide ideal wide ratio spreads for optimum performance.

» **DRIVER-ADAPTIVE SOFTWARE.** *By reprogramming the software, we improved overall control and efficiency. ERS—Electronic Range Select—allows the driver to manually select the gear best suited for the task at hand. The engineering shows its true mettle when mated to the 5.7L and 6.4L HEMI® V8 engines.*

» **STANDARD TOW/HAUL MODE.** *Transmissions are designed and constructed for stout towing and robust hauling assignments, with standard Tow/Haul Mode to facilitate tough jobs and help improve performance and fuel efficiency.*

RAM 1500 PICKUP THE TORQUEFLITE® 8-SPEED AUTOMATIC TRANSMISSIONS (8HP45/8HP70)



AUTOMATIC PARTNER FOR RAM 1500. The objective was manifold: provide outstanding drivability and impeccable performance from highway cruising to heavy hauling while making a very real contribution to the impressive Ram 1500 fuel efficiency. Revolutionizing the transmission field, the TorqueFlite 8-speed with standard Tow/Haul Mode in Ram 1500 is standard with the available 3.0-liter EcoDiesel V6⁶; the 3.6-liter Pentastar® V6 and the available 5.7-liter HEMI V8.

WORK WITH ROTARY PRECISION. *Electronically controlled. Ergonomic design. Dashboard-mounted. The innovative Rotary Shifter for the TorqueFlite 8-speed automatic offers convenient, responsive shifting for all situations.*



RAM 2500/3500 HD PICKUPS AND 3500/4500/5500 CHASSIS CABS THE 6-SPEED MANUAL TRANSMISSION (G56)



MATED ONLY TO THE 6.7L CUMMINS® TURBO DIESEL, this is the transmission for Ram Heavy Duty pickups and Chassis Cabs equipped with the 660 (on pickups)/650 (on Chassis Cabs) lb-ft versions.

On Ram Chassis Cab models, the robust G56 6-speed delivers optional PTO capability. This class-exclusive^{8,12,14} manual transmission is invaluable when you're looking for the ultimate combination of vehicle control and efficiency.

» **THIS PTO TOTALLY SIDES WITH BUSINESS.** *The G56 6-speed manual offers available and robust PTO access for Chassis Cabs, significantly boosting Ram Chassis Cab capability.*

» **SELF-ADJUSTING AND WEAR-COMPENSATING CLUTCH.** *Count on long life and "like-new" clutch pedal feel, enhancing drivability and helping reduce the costs and hassles of downtime.*

RAM 2500/3500 HD PICKUPS (DIESEL) DURABILITY DEFINED: THE 6-SPEED AUTOMATIC TRANSMISSION (68RFE)

MATED TO THE AVAILABLE 370/800 6.7L CUMMINS TURBO DIESEL. Heavy Duty 2500/3500 models with the 370 hp/800 lb-ft calibration of the Cummins employ the 68RFE, an established partner built to handle the output. Standard Electronic Range Select (ERS) ensures optimal and quiet shifting of gears for ideal load control while towing and hauling; three planetary gearsets provide capability with precise ratio steps for optimum drivability.

» **FIVE HYDRAULIC ACCUMULATORS** *help smooth the shift points, delivering seamless transitions irrespective of speed or load.*

» **DRIVER-ADAPTIVE SHIFTING** *is a virtual electronic brain at work, and further customizes the shift points; the software bases the gear transitions on driver input.*

» **ELECTRONIC RANGE SELECT** *allows manual control for greater confidence.*

TORQUE LEVELS THIS IMPRESSIVE LET YOU SCOFF AT HARD LABOR.



THE AISIN® HEAVY-DUTY 6-SPEED AUTOMATIC FOR RAM CHASSIS CAB^{8,12} AND RAM 3500 PICKUP

The AISIN Heavy-Duty 6-speed automatic mated to the 6.4L HEMI® V8 is the AS66RC version, delivering exceptional capability. This AISIN version is standard on Ram 4500/5500 models and is available for Ram 3500 Chassis Cabs.

Firmly established in the industrial world is the heavy-duty AISIN that continues to earn accolades—the tough AS69RC calibration. It's engineered to deliver absolutely peak performance with the available Cummins® High Output versions. (Available for Ram 3500 pickup and 3500/4500/5500 Chassis Cabs.)

Look for exceptionally robust inner components and casings—like this high-strength case that improves durability and reduces noise, vibration and harshness (NVH).

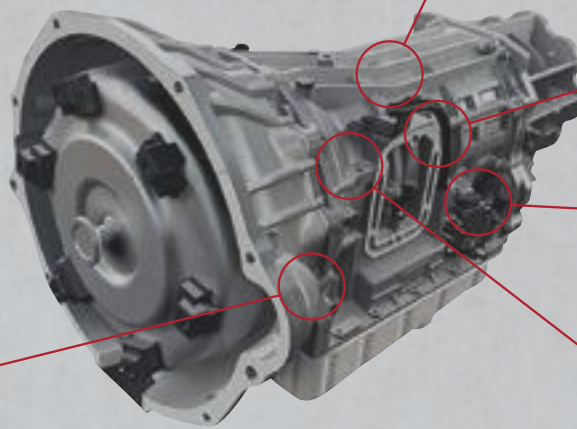

Shift strategy is through the Transmission Control Module (TCM), which relies on numerous direct and indirect inputs (via sensors) to determine driver demand and vehicle operating conditions. Performance is remarkably potent and notably quiet.

The compact gear train utilizes three clutches, two brakes and a refined shift control algorithm. AISIN clutches are specifically engineered to meet commercial truck applications.

The Shift Control System is impressively responsive and enables continuous operation in the most fuel-efficient speed range.

A patented and highly specialized heat treatment is used to develop ultra-high-strength planetary gear components—part of the reason for the long life and solid reliability.

STRENGTH WITH INTELLIGENT PTO: THE AISIN SURPASSES EXPECTATIONS WITH FLYING COLORS.

THE FORMIDABLE 6.4-LITER HEMI V8 AND CUMMINS TURBO DIESEL engines deserve a partner that can handle their respective levels of horsepower, torque and various vehicle weight ratings. The available AISIN Heavy-Duty 6-speed automatic is calibrated for ideal performance with each of these commercial-grade powerplants.

Notable strengths of all AISIN 6-speed transmissions show the commitment and thought put into these formidable components. Among the industrial-grade assets are: full electronic control of shifting, including electronic operation of the torque converter clutch; tough clutches, upgraded for commercial truck applications; a highly sophisticated Transmission Control Module (TCM), which even communicates with the engine controller to momentarily turn off the exhaust brake (on Cummins powered models) while shifting to protect the friction material; and a vigorous Tow/Haul Mode that delivers an aggressive downshift schedule to meet industrial-level hauling demands.

This engineering is focused on durability and efficient operation. Included are six forward ranges (including two overdrive gears for ultra-efficient performance), wide overall gear ratios, a refined Shift Control System and low 1st-gear ratio of 3.75:1. In both iterations, the AISIN AS66RC and the AS69RC deliver superb performance with outstanding vehicle launch ability—an absolute mandate for long-term towing assignments.

- » **RAM CHASSIS CAB: COUNT ON A GAS-POWERED V8 WITH AVAILABLE PTO.** *Select 2017 Ram Chassis Cabs equipped with the 6.4-liter HEMI V8 deliver it all. The available PTO capability from this powertrain carries true authority, delivering up to 60 horsepower and 250 lb-ft of torque.*
- » **DUAL-ACCESS PTO DOUBLES YOUR EFFICIENCY.** *Choose your side—and your engine—and get the job done with fluent proficiency. AISIN dual-access PTO capability with the 6.4L HEMI V8 and Cummins Turbo Diesel is the solution. On Chassis Cab models, left-side access is reserved for hydraulic or higher-output/shaft-driven power take-off. This engineering focuses on cost-effective operations that help reduce costs of ownership, dispensing with the common floor-mounted patch plate; the design eliminates the need for (and expense of) upfitters working around the exhaust system on diesel-powered models.*
- » **EXCLUSIVE PTO CAPABILITY WITH BUILT-IN FUEL EFFICIENCY.** *The AISIN design is intelligent, with technology that adapts to the 6.4-liter HEMI V8 Multi-Displacement System (MDS)/Fuel Saver Technology. While in stationary mode, the PTO with the AISIN AS66RC is modified to operate using only four cylinders rather than all eight; the efficiency is measurable.*
- » **MASSIVE TORQUE CONVERTER.** *The torque converter of the AISIN AS69RC Heavy-Duty 6-speed is sized for the task, measuring over 12 inches in diameter, with a multiple disk friction pack to help improve slip control and shift quality.*

CONFIGURATIONS

	1500 PICKUPS		2500 AND 3500 PICKUPS		3500, 4500 AND 5500 CHASSIS CABS				
	SRW		SRW	DRW	SRW	DRW			
 REGULAR CAB	 RB 6'4"	 8'	 8'	 8'	 60"	 60"	 84"	 108"	 120"
			2500, 3500	3500	3500	3500, 4500, 5500	3500, 4500, 5500	4500, 5500	4500, 5500
 QUAD CAB®	 RB 6'4"								
 CREW CAB	 RB 5'7"	 RB 6'4"	 RB 6'4"	 8'	 8'	 60"	 60"	 84"	
			2500, 3500	2500, 3500	3500	3500	3500, 4500, 5500	4500, 5500	
 MEGA CAB®			 RB 6'4"	 6'4"					
			2500, 3500	3500					
									000 CARGO BED LENGTH 000 CAB-TO-AXLE LENGTH (CA) RB RAMBOX® SYSTEM AVAILABLE SRW = SINGLE REAR WHEEL DRW = DUAL REAR WHEEL

RAM PROMASTER CITY®	
 TRADESMAN® CARGO VAN	 122.4 87.2
 PASSENGER WAGON	 122.4 69.2
000 WHEELBASE LENGTH IN INCHES 000 LOAD FLOOR LENGTH IN INCHES	

	RAM PROMASTER® 1500	RAM PROMASTER 2500	RAM PROMASTER 3500
 CARGO VAN (STANDARD ROOF)	 118 105.1 195.4	 136 122.8 213.1	
 CARGO VAN (HIGH ROOF)		 136 122.8 213.1	 136 122.8 213.1
 WINDOWED VAN (HIGH ROOF ONLY)		 136 122.8 213.1	 159 145.9 236.0
 CHASSIS CAB/ CUTAWAY (STANDARD ROOF ONLY)		 159 145.9 236.0	 159 145.9 236.0
			 159 EXT 160.2 250.5
			 136 81.1 207.0
			 159 104.1 230.0
			 159 EXT 104.1 244.4

000 WHEELBASE LENGTH IN INCHES
EXT BODY/CHASSIS EXTENDED 14 INCHES
000 LOAD FLOOR LENGTH IN INCHES
000 CAB-TO-AXLE LENGTH IN INCHES
000 OVERALL BODY LENGTH IN INCHES

BUSINESS LINK

The fast lane for small business.

THE DEALER NETWORK FOR YOUR BUSINESS.

Your **BusinessLink** dealer is committed to providing you, the small business owner, with the vehicle support you need for your business. From servicing all makes and models of your existing vehicles to selling you the right vehicles needed to perform the work that you do. Your **BusinessLink** dealer provides next-available-bay service because we know

downtime is costing you money. Your **BusinessLink** dealer has sales professionals trained to properly "job-rate" the right vehicle for your work application along with providing commercial finance options. New vehicle sales to qualified small business owners also include a free alternate transportation contract, in the event your vehicle is in for service.

Membership in the **BusinessLink** program is complimentary. Membership helps us to identify you as a small business owner so we can provide you with both the service you deserve and update you with offers that can help reduce the cost of doing business. For your free registration, see your **BusinessLink** dealer today.

ON THE JOB**INCENTIVES FOR SMALL BUSINESSES.**

Running a business presents plenty of challenges. Like cutting costs, not corners. Like saving time and money and eliminating hassles. The **ON THE JOB**²⁸ commercial incentive program provides assistance in customizing and servicing your business vehicles.

Our most popular **ON THE JOB**²⁸ incentives are:

- **COMMERCIAL EQUIPMENT/UPGRADES.** \$500/\$1,000 Allowances for Uppfits, \$1,000 Box-Off Allowance, \$500 RamBox[®] Cargo Management System Allowance.
- **COMMERCIAL GRAPHICS ALLOWANCES.** \$250/\$500/\$1,000 Commercial Graphics Allowances.
- **BOSCH[®] TOOL OFFER.** Select 1 of 5 current Bosch Power Tool Packages.
- **2-YEAR LUBE/OIL/FILTER.** For all Chrysler, Dodge, Jeep[®], and Ram vehicles (includes gas and diesel engines).
- **MOPAR[®] SERVICE CONTRACTS.** \$500/\$1,000 and Oil Change options available.

See your dealer for specific program rules and details or call us toll-free at **877-ONTHEJOB (877-668-4356)**.

A commercial line of credit from Chrysler Capital is ideal for qualified business customers looking for a flexible, easy way to manage growing vehicle needs. Chrysler Capital streamlines the process—and with prequalification, you're ready to buy a vehicle when you need it. Ask your **BusinessLink** dealer for details.

CHRYSLER
C A P I T A L

1 Based on IHS Automotive VIO registration data for all brands of GVW 1 – 3 pickup trucks continuously sold in the U.S. since 1988, Dodge and Ram have the highest overall percentage still on the road. 2 Efficiency based on best-in-class payload, cargo capacity and fuel efficiency on Ram ProMaster City. Class is Small Commercial Van segment. 3 Based on Standard Pickup class. Manufacturer's estimated 29 highway mpg based on EcoDiesel HFE 4x2. Actual results may vary. 4 Based on latest available competitive information. Class is based on Large Commercial Van segment (Class 2). 5 Based on latest available competitive information. Class is Small Commercial Van segment. 6 Based on latest available competitive information. Class based on light-duty pickups. 7 Based on Class 5 pickup-based conventional cab chassis. 8 Based on Class 4 – 5 pickup-based conventional cab chassis. 9 Based on Class 4 pickup-based conventional cab chassis. 10 Always look before proceeding, electronic drive aid is not a substitute for conscientious driving; always be aware of your surroundings. 11 No system, no matter how sophisticated, can repeal the laws of physics or overcome careless driving actions. Performance is limited by available traction, which snow, ice and other conditions can affect. When the ESC warning lamp flashes, the driver needs to use less throttle and adapt speed and driving behavior to prevailing road conditions. Always drive carefully, consistent with conditions. Always wear your seat belt. 12 Based on Class 3 – 5 pickup-based conventional cab chassis. 13 Based on Class 3 pickup-based conventional cab chassis. 14 Based on latest available competitive information. Class based on 250/2500 and 350/3500 pickups. 15 Based on latest available competitive information. Class based on all full-size pickups. 16 Based on latest available competitive information. Class based on 250/2500 pickups. 17 SiriusXM subscriptions for audio and data services are sold by SiriusXM to follow your trial subscription. If you decide to continue listening after your trial, the subscription plan you choose will automatically renew thereafter and you will be charged according to your chosen payment method at then-current rates. Fees and taxes apply. To cancel, you must call SiriusXM at 1-866-635-2349. See the SiriusXM Customer Agreement for complete terms and more information at siriusxm.com. All fees and programming subject to change. Your equipment and features for SiriusXM services will vary depending upon the vehicle you select and may be limited in select markets. 18 Wi-Fi subscription required. This feature is not intended for use by the driver while the vehicle is in motion. Always drive carefully. 19 Vehicle must be within the United States, have network coverage and must be registered with Uconnect Access with an active subscription that includes the applicable feature and you must fulfill minimum subscription requirements. It must also be equipped with features that enable remote commands, such as keyless entry, and must be in active and usable cellular range. The Uconnect Access App must be installed and launched on your mobile device to use these remote commands. Remote features are available only on vehicles that are properly equipped. Check state and local laws regarding the use of remote start systems. 20 Siri[®] Eyes Free requires an iPhone[®] mobile device equipped with the Siri feature. Certain features not available while the vehicle is in motion. iPhone must be within active cellular range. Customer's existing iPhone data rates apply to Internet-supported features. 21 Requires a mobile phone equipped with the Bluetooth Hands-Free Profile. Visit UconnectPhone.com for system and device compatibility. 22 The 9-1-1 Call button will connect you directly with Emergency Assistance. If you accidentally press the button, you have 10 seconds to cancel the call by either pressing the 9-1-1 button on the rearview mirror or the Cancel button on the Uconnect touchscreen. 23 Provides direct-dial access to Roadside Assistance Service. Vehicle must be within the United States, have network coverage and must be registered with Uconnect Access with an active subscription that includes the applicable feature. Additional roadside assistance charges may apply. Check warranty for details. 24 Wi-Fi subscription required. Vehicle must be registered with Uconnect Access and fulfill minimum subscription requirements. Vehicle must be properly equipped and in active and usable cellular range for Wi-Fi usage. Wi-Fi Hotspot does not enable direct communication between multiple in-vehicle devices. Factors affecting the performance of Wi-Fi Hotspot include: cellular network, signal strength and quality, time of day, number of channels used by the service provider, type of connection, number of clients using Wi-Fi Hotspot and client device. This feature is not intended for use by the driver while the vehicle is in motion. Always drive safely. 25 Based on ALG's residual value forecast for the 2017 Ram ProMaster City. 26 Transferable. See dealer for complete details and a copy of the 5-Year/60,000-Mile Gas Powertrain Limited Warranty. 27 Transferable. See dealer for complete details and a copy of the 5-Year/100,000-Mile Diesel Powertrain Limited Warranty. 28 ON THE JOB is a retail incentive program; see your dealer for official rules. Inquire about eligibility by calling 877-ONTHEJOB or by logging on to fcaworkvehiclesus.com. The purchaser or lessee must be a qualified commercial customer for more than 30 days prior to the date of the vehicle purchase. An official ON THE JOB Customer Acknowledgment Form must be signed by the customer (provided by the dealer).

©2017 FCA US LLC. All Rights Reserved. Chrysler, Dodge, Jeep, Ram, Mopar, the Ram's Head logo, Active Air, AllSecure, Automobility Program, Big Horn, BusinessLink & design, HEMI, Laramie, Laramie Longhorn, Mega Cab, ParkSense, ParkView, Pentastar, Power Wagon, Quad Cab, RamBox, Ram ProMaster, Ram ProMaster City, Tigershark, TorqueFlite, Tradesman and Uconnect are registered trademarks and Active-Level, HFE High Fuel Efficiency & Design and On The Job & design are trademarks of FCA US LLC. Chrysler Capital is a registered trademark of FCA US LLC and licensed to Santander Consumer USA Inc. MultiAir is a registered trademark of C.R.F. Società Consortile per Azioni, used under license by FCA US LLC.

iPhone and Siri are registered trademarks of Apple Inc. Bosch is a registered trademark of Robert Bosch GmbH. Cummins is a registered trademark of Cummins, Inc. AISIN is a registered trademark of Aisin Seiki Co., Ltd. CNH, Case IH and New Holland are registered trademarks of CNH America LLC. Sirius, XM and all related marks and logos are trademarks of Sirius XM Radio Inc. Katerack is a registered trademark of Dejana Truck & Utility Equipment Co. All rights reserved. Brembo is a registered trademark of Brembo S.p.A. Facebook and logo are registered trademarks of Facebook, Inc. Instagram and logo are registered trademarks of Instagram, Inc. The Twitter logo is a service mark of Twitter, Inc. The YouTube logo is a registered trademark of Google Inc. Knapheide is a registered trademark of Knapheide Manufacturing Company. Yelp is a registered trademark of Yelp. Bluetooth is a registered trademark of Bluetooth SIG, Inc. Green Car of the Year is a trademark of Green Car Journal and RJ Cogan Specialty Publications Group, Inc.

About this catalog: since the time of printing, some of the information you'll find in this catalog may have been updated. Ask your dealer for details. Some of the equipment shown or described throughout this catalog may be available at extra cost. Specifications, descriptions, illustrative materials and all competitive comparisons contained herein are as accurate as known at the time this publication was approved for printing. FCA US LLC reserves the right to discontinue models at any time or change specifications without notice or without incurring obligation. Options may be required in combination with other options. For the price of the model with the equipment you desire, or verification of specifications contained here, see your Ram dealer.

YOUR GO-TO ONLINE SOURCE FOR RAM GEAR: RAMTRUCKS.COM/OUTFITTER**RAM OUTFITTER**

RAMTRUCKS.COM/OUTFITTER



Join our community on Facebook, submit your photos on Instagram, follow us on Twitter and check us out on YouTube.

**RAM ZONE**

Join fellow Ram enthusiasts and tell your story by posting comments, participating in discussions and sharing your photos and videos.



[RAMTRUCKS.COM/COMMERCIAL](https://ramtrucks.com/commercial)