



... AMERICA'S BADGE OF AUTHORITY



60

FORD POLICE CARS  
and Emergency Vehicles

# FORD... MORE THAN EVER... THE ACTION FAVORITE IN LAW ENFORCEMENT... YOU CAN DEPEND ON IT!

## Triggered by Interceptor performance and staying power

The mighty Police Interceptor V-8 is for men of action on the move in law enforcement! It's the kind of an engine that bears down in any emergency to deliver instant response and high-speed staying power without letup. Ford's famous ahead-of-the-field performance and better handling, extra built-in safety and greater stamina are what have made it America's badge of authority... made it, for years, the favorite for law enforcement over all other makes of cars combined!



## Built-in, round-the-clock stamina and dependability

Ford, always a bear for punishment, is even brawnier in 1960. Starting with Ford's deeper, more massive Wide-Contoured frame right on through every inch of Ford's built-to-last chassis, and more durable all-new body with high-strength-to-weight ratio, there's a great new reservoir of strength... the kind of strength that measures up to every emergency right around the clock! You don't have to pamper a Ford because Ford is built to last with minimum time-out for maintenance.

## Lifeguard Design for all-around, full-time safety

Only Ford meets the need for extra safety in so many ways with built-in Lifeguard Design. There's a 25% stronger, safety-type frame... reinforced roof panel... new sight-for-safety visibility with bigger windshield and 33 1/2% larger wiper pattern... Safety-Curved instrument panel... Lifeguard steering wheel... Double-Grip door locks... Safety-type seat anchorage and Truck-Size brakes—the biggest in Ford's field. These, and other safety features are standard on the 60 Fords.

## Riding Comfort with room to spare

You get the comfort extras at no extra cost in a 60 Ford. Chair-high, 23° Posture-Perfect foam-padded front seats... more stretch-out leg room, hip room, and broad-shoulder room... wider doors with no "dogleg" for easy, fast entrance and exit... ride-cushioning, Swept-Back Front Suspension with longer coil springs... longer asymmetric, anti-squat-anti-dive rear springs... the best sound and weather insulation in Ford's field. Up to 31% more glass, yet everyone sits under the shade of the roof!



## Ford leads in meeting police needs for comfort, convenience, safety!

### NO "DOGLEG" ... EASY ENTRANCE AND EXIT

Ford has eliminated the annoying windshield extension or "dogleg" still found in the pillar design of so many cars, without sacrificing visibility. Big 50.4" wide doors with 2-stage door checks and more foot room, too, provide much easier entrance-exit.



### "STRETCH-OUT" ROOM IN FRONT SEATS

The 60 Fords are roomier inside than ever. Husky 6-footers have plenty of "stretch-out" leg room, hip room and shoulder room... with deep, thickly padded, full-width cushions... and there's plenty of head (and hat) room for even the biggest man on the squad.

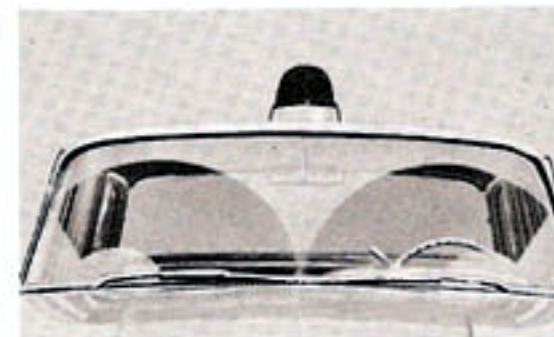
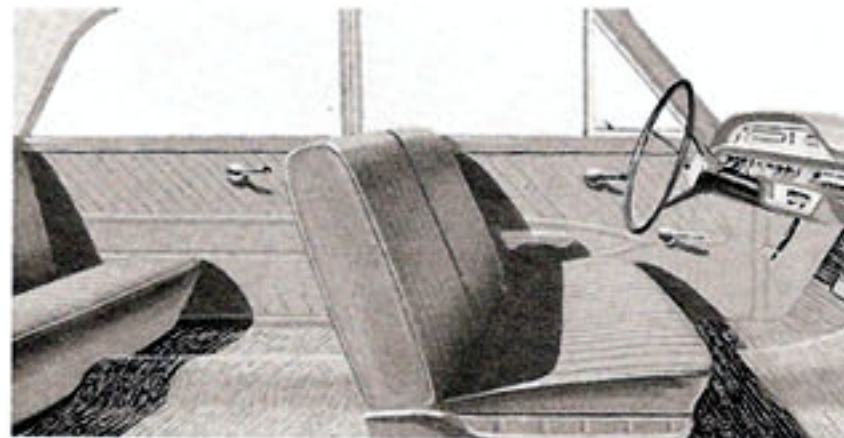

### FULL-VISION COMPOUND WINDSHIELD ... LARGER WIPER PATTERN

Big, new Wide-Angle Windshield wraps at the sides and curves into the roof for 55% greater out-front, sky-to-road visibility, yet ample overhead protection from the sun. Longer 15 in. windshield wipers clean 1/3 more glass. Slimmer, slant-forward windshield pillars further increase visibility.



### LIFEGUARD STEERING WHEEL

Deep-dish, safety design, with three equally spaced spokes to absorb high impact, offers extra driver protection against chest injury from the steering post in case of collision.



### NEW TRUCK-SIZE BRAKES

Ford has the biggest brakes in the low-price field! Lining area has been increased to 225.6 sq. in. (248.4 sq. in. with Interceptor V-8). Heavier, wider brake drums are externally grooved for faster cooling, greater fade resistance, longer brake life. Larger, optional 15" wheels speed brake cooling, too, for extra safety.



### LIFEGUARD DOUBLE-GRIP DOOR LOCKS

Ford's Lifeguard Double-Grip Door Locks actually exert holding pressure in six directions... stronger than ever, they now resist impact pull-apart forces of 3,000 pounds minimum. This safety feature is especially desirable in commercially operated vehicles as well as private passenger cars in case of collision.



*Powered... designed... and built to surpass*



### New 60 Ford Fairlane Series

Dollar for dollar, there isn't a better car built for police duty than the 60 Ford Fairlane Club Sedan... it's the value-performance leader at Ford's traditionally low price. It's a sleek beauty... but more important to you is the way it stands up under punishment and delivers road-scorching performance month after month with Ford's great 1960 engine-transmission team combinations.

Check this Ford 2-door Fairlane against anything on the road... it will "outgun," outride, outmaneuver and outlast other makes—it's built to beat the field from bumper to bumper!

## FORD MULTIPLE-DUTY VEHICLES



### 60 Ford Ranch Wagons

The 6-passenger two-door and Fordor Ranch Wagons have a longer 119" wheelbase and wider 61" front—60" rear treads. They're bigger inside, too... 9" longer, 3" wider with more passenger room and greater loadspace for carrying police emergency equipment. Rear opening is up to 1½ ft. wider than competitive makes. Durable interior trim combinations are available in: two-tone blue or green vinyl and woven plastic or all-vinyl beige. Instrument panel, seat side shields and garnish moldings are all color-keyed. Long-wearing, Sof-Tred carpet-textured, black rubber floor covering in passenger area and blue, green or beige ribbed vinyl in cargo area are standard.



### Ford Country Sedans

You can get your choice of two Ford Country Sedans: the 6-passenger 4-door model or the 9-passenger 4-door. They give you up to 5" more shoulder room... over 2" more hip room... and a new lanky length of leg room... plus foam-padded seats throughout. Side and liftgate doors are wider. There's a whopping cargo capacity of over 97 cu. ft. behind front seat. Color-keyed interiors are attractively trimmed in: blue, green or turquoise vinyl and woven plastic; red or beige all-vinyl. Durable black Sof-Tred passenger area floor covering and color-keyed ribbed vinyl cargo area are standard.

## FOR EVERY POLICE DUTY...THERE'S A FORD TO DO IT BETTER!



### Built-for-big-men interiors

Ford builds roomy comfort for big men of action... there's chair-high, 23° Posture-Perfect, foam-padded front seats... new, inclined 12-ball-bearing seat tracks for smoother operation... seats adjust to 11 different seating positions with fore-and-aft travel of 5½ in. (An optional Manual-Tilt, 4-Way Front Seat provides a choice of *fifty-five different seat positions*, including five tilt adjustments.) Fairlane interior trim combinations offer, as standard, a choice of durable blue, green or gray Block Stripe nylon fabric with harmonizing Morocco Grain vinyl bolsters. Three extra-durable, all-vinyl interiors are available as options in a choice of beige for all models (illustrated), or in green or red for the Fairlane Town Sedan.



### Ford Fairlane Town Sedan

Here's a '60 Fairlane 4-door Sedan with all of Ford's wonderful new 1960 features, too... husky Inner Ford and chassis... sight-for-safety visibility all around... biggest brakes in Ford's field and other Ford Lifeguard safety extras... greater leg, hip and shoulder room in front and rear seats... wider front and rear doors... a road-hugging 5 x 5 ride with new Wide-Tread design... easier steering and great, new engine-transmission combinations to keep you miles ahead in every respect!



### 60 Ford Station Wagon Conversion Options

All 60 Ford Station Wagons are readily adaptable for ambulance, fire fighter, rescue and other emergency uses with fully tested and proved conversion options. A side-opening rear door which is hinged at the left to facilitate easy, safe loading from the curb may be special-ordered. The station wagon may then be converted into any one of a number of fully equipped emergency vehicles. Illustrated is a complete ambulance unit using a Country Sedan as converted by Automotive Conversion Corp., Birmingham, Michigan.



Foldaway seats tuck under quickly and easily to increase the cargo loadspace. New third seat back simply folds forward after slip-off, thick-foam cushions are removed.



With the two rear seats up, there is room for up to 9 passengers and over 3 ft. of floor length back of the third seat for emergency equipment, tool

Only Ford in the low-price field can offer you three forward-facing seats in its 9-passenger models!

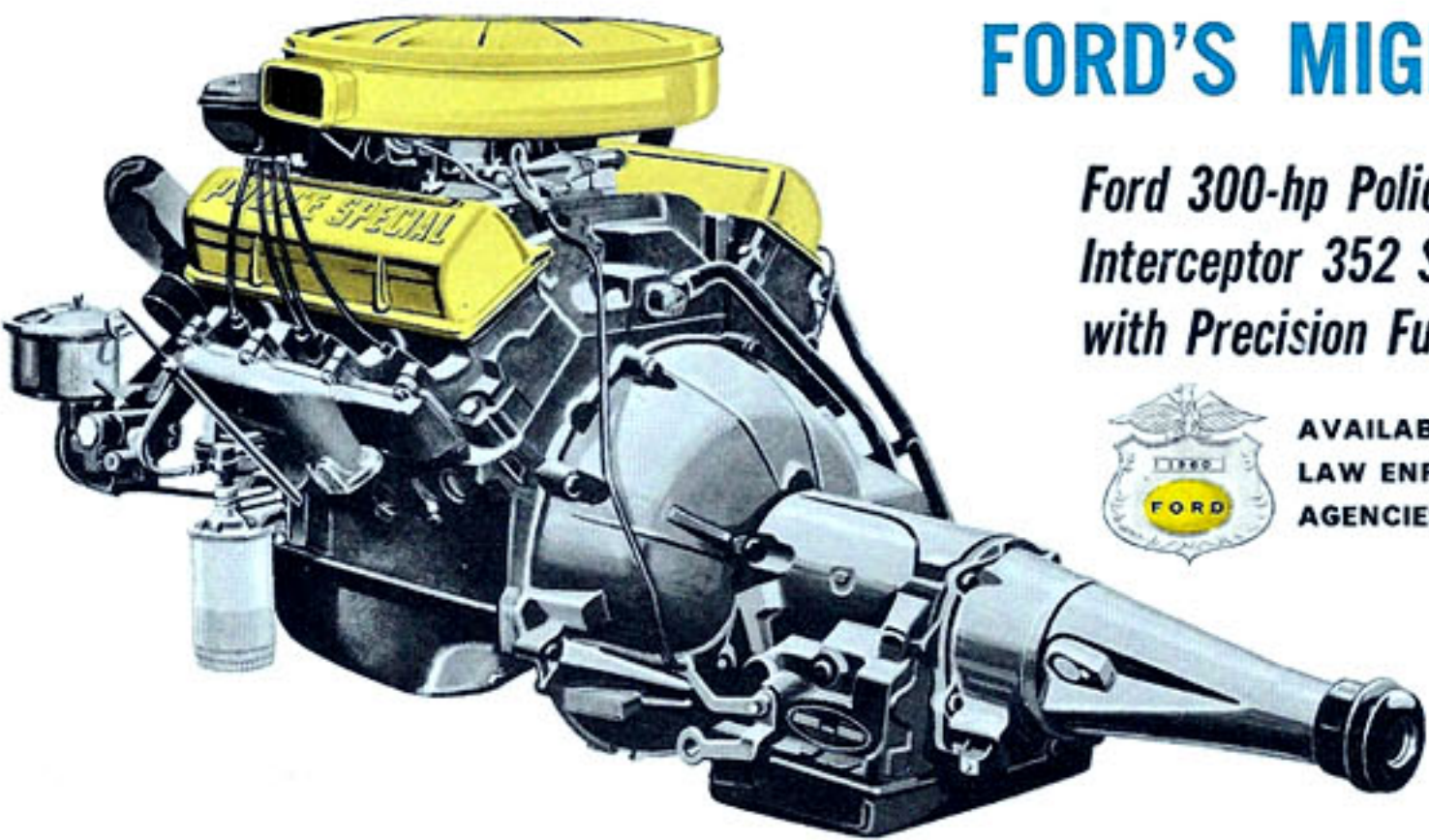

# FORD'S MIGHTY POLICE INTERCEPTOR V-8

**Ford 300-hp Police Interceptor 352 Special V-8 with Precision Fuel Induction**



**AVAILABLE ONLY TO LAW ENFORCEMENT AGENCIES**

Ford's Police Interceptor V-8 is specially designed to meet exacting police needs for lightning-like acceleration, blazing performance and staying power. It is available only to law enforcement agencies.

Every important advancement in modern V-8 engine design has been incorporated in this engine. There's Ford's exclusive Precision Fuel Induction system that forces the fuel-air mixture directly into combustion chambers more rapidly and uniformly for smoother, faster power response with greater economy. Wedge-type combustion chambers swirl the premium fuel-air mixture at superhigh velocity for peak power output.

The Ford Police Interceptor engine has a specially designed, high-speed camshaft combined with special high-performance intake and exhaust valve springs and solid valve keepers—further adding to the blazing performance and around-the-clock pursuit power of the mighty Interceptor.

For ruggedness, no other engine can match Ford's Interceptor V-8 with its sturdy Deep-Block design, precision-molded, alloy-iron crankshaft, aluminized valve heads and countless other long-life features.



## POLICE INTERCEPTOR V-8 PACKAGE

... includes: Heavy-duty front, rear springs; heavy-duty front, rear shock absorbers; fade-resistant, riveted brake linings with 248.4 sq. in. area and heavy-duty brake drums specially grooved for faster cooling and longer life; 7.10 x 15 4-ply nylon tires on heavy-duty 15 x 5K wheels for better brake cooling and safety at high speeds; 65 amp-hr battery when automatic transmission is installed; extra cooling capacity radiator; special pulley for higher-speed fan operation; precision-type speedometer gear for high-accuracy speed indication.

## CHOICE OF 4 TRIGGER-TORQUE TRANSMISSIONS



### CRUISE-O-MATIC DRIVE

Offers a choice of two full-time driving ranges: "D<sub>1</sub>"—used for all normal driving—gives brisk, solid take-offs in low; D<sub>2</sub> gives gentle, sure-footed starts in 2nd on wet, icy or loose surfaces. Has new 12" converter and increased stall speed. The Interceptor V-8 comes with a special 3.10 axle ratio for superhigh performance.



### FORDOMATIC DRIVE

Lightweight cast-aluminum construction. Simplified design utilizes a single-stage, 3-element torque converter and a compound planetary gear set with only one clutch assembly that provides two forward gear ratios, plus reverse. New cellulose clutch plates and lower clutch pressures make the Fordomatic smoother than ever.



### THRIFTY OVERDRIVE

Delivers more miles per gallon, saves on engine wear and permits quieter driving. Economical automatic 4th gear lets the engine turn over at about 28% fewer rpm than is required for the same road speed in direct gear—you cruise along smoothly. Provides "kick-down" into direct gear (by flooring accelerator) for fast pickup.



### HIGH-TORQUE CONVENTIONAL DRIVE

Provides three manual-shift forward speeds and a reverse. Has a semi-centrifugal, cushion-disc type, high-torque transmitting clutch. Features rugged, all helical gears with synchronizers for extra long life and smooth, quiet shifting at all speeds. Ratios torque-tailored to each engine.

## HIGHLIGHT FEATURES

- Engine electronically mass-balanced under own power for factory-tested optimum smoothness
- Super-Fitted aluminum alloy pistons with long skirts for better oil control and wear-resistant chromed top ring
- Standard vacuum-booster type fuel pump for more constant windshield-wiper action. New in-line fuel filter provides 50% better filtration
- High velocity, low silhouette 4-barrel carburetor for most versatile and economical operation at all speeds
- New automatic choke for improved cold-weather idling, greater gas economy and longer-lived precision operation
- Self-adjusting hydraulic valve lifters provide more accurate valve functioning for optimum performance, quieter operation
- Positive full-pressure lubrication provides correct oil feed to all frictional surfaces for quieter and longer engine life
- New Full-Flow Oil Filter with 2-phase, depth-type filtration bed is 20% more effective in keeping the oil clean than other types
- Aluminized intake and exhaust valves provide maximum protection against pitting and burning for longer valve life
- Precision-molded special alloy crankshaft has large journal overlap for extra rigidity, longer life, smoother performance
- Large size, long-lived copper-lead main and connecting rod bearings for extra strength and durability
- Large alternate intake and exhaust valves and ports for best cooling, freer breathing and greater economy
- New Super-Filter air cleaner for maximum engine protection and easier, more economical maintenance
- Turbo-Action, gasketless, triple-seal 18-mm. spark plugs with long central core for greater self-cleaning action and full combustion
- New distributor vacuum-control mechanism with new breaker plate supported by 3 nylon buttons for smooth, stable operation
- New special resistance wire in distributor-point circuit for greater reliability and elimination of "blue points"

# ... AND 3 OTHER PEAK PERFORMANCE ENGINES

## 235-hp Thunderbird 352 V-8

This all-new police car option features Ford's Precision Fuel Induction system ... high-velocity, 2-barrel carburetor and wedge-type combustion chambers for high turbulence fuel-air mixture, full combustion and instant-responding performance ... new Super-Filter air cleaner ... Short Stroke, low-friction design for economy and long engine life ... free-turning aluminized valves with hydraulic lifters and alternate intake-exhaust valve placement for longer life ... precision-molded crankshaft ... copper-lead main and connecting rod bearings ... full pressure lubrication with new disposable 2-phase Full-Flow Oil Filter ... sturdy Deep-Block design for greater structural rigidity ... and gives top-flight performance on regular gas.

## 185-hp Thunderbird 292 V-8

In Ford's Thunderbird 292 V-8 you get all the time-proved engine features for high performance, dependability and economy. This engine has new, smaller intake valves for better fuel economy ... new, recontoured wedge-type combustion chambers for smoother, more efficient combustion and full power development ... high-velocity 2-barrel carburetor for gas-saving efficiency on regular gasoline ... new precision automatic choke and many other fine engine features. Like all Ford V-8 engines, it is electronically balanced under its own power for optimum smoothness at all driving speeds.

## 145-hp Mileage Maker Six

The 1960 Ford Mileage Maker Six—the only experienced, modern Short Stroke engine in its class for more nimble, economical performance—features Ford's rugged Deep-Block design ... more efficient engine cooling with Cross-Flow pressurized radiator and separate reserve tank ... new rocker cover with rim-type, hold-down bolts for better oil sealing and reduced noise ... new high-output 12-volt generator has sealed ball bearings at front and rear for smooth operation and long life ... new Rotor-type oil pump for greater reliability and a host of other economy and long engine-life features.

## ENGINE SPECIFICATIONS AND AVAILABILITY

ENGINE	HP	TORQUE	CARB.	EXH.	BORE AND STROKE	COMP. RATIO	CU. IN. DISPL.	TRANSMISSION
Police Interceptor 352 Special V-8	300	381 lbs-ft	Four-barrel	Dual	4.00" x 3.50"	9.6 to 1	352	Conventional Overdrive Cruise-O-Matic
Thunderbird 352 V-8	235	350 lbs-ft	Two-barrel	Single	4.00" x 3.50"	8.9 to 1	352	Conventional Overdrive Fordomatic Cruise-O-Matic
Thunderbird 292 V-8	185	292 lbs-ft	Two-barrel	Single	3.75" x 3.30"	8.8 to 1	292	Conventional Overdrive Fordomatic Cruise-O-Matic
Mileage Maker Six	145	206 lbs-ft	Single-barrel	Single	3.62" x 3.60"	8.4 to 1	223	Conventional Overdrive Fordomatic

# ALL-NEW INNER FORD FOR 1960

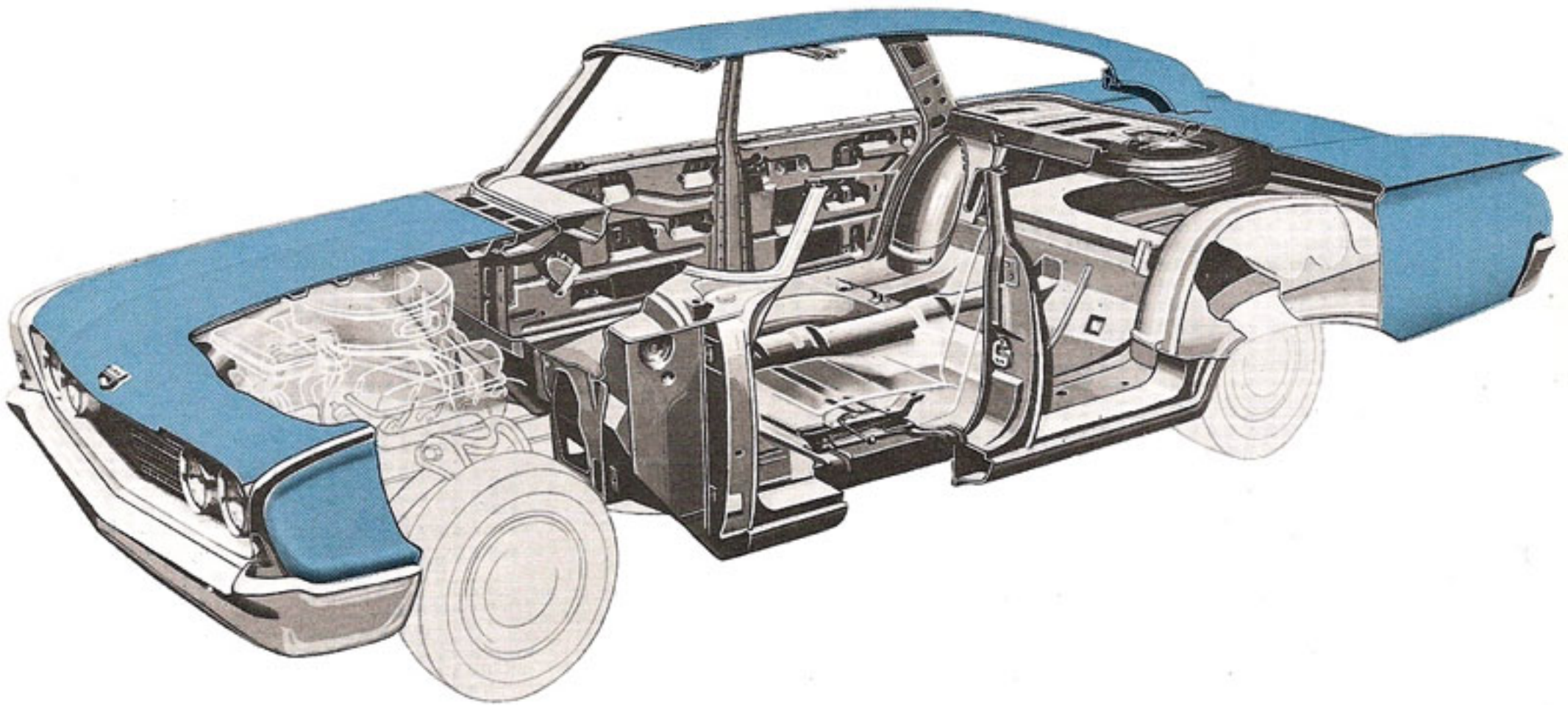

## Built for "years ahead" endurance under punishment!

Ford, traditionally an outstanding durable performer, is beefier than ever for 1960. Everything about the 60 Ford body structure is sound, solid, silent and secure . . . built to take the around-the-clock punishment of police service with minimum maintenance. All points of stress are strongly reinforced . . . not one detail has been overlooked to provide you with 1960 Ford police cars that do a better job—more economically and with less fuss—than any car in its price class.

- New larger compound windshield, easy-entrance pillars swept forward with no "dogleg" and gracefully sloping hood combine to give greater vision all ways out front for safer driving
- Clear-vision safety glass throughout, with up to 31% greater glass area—but with none over passengers' heads—gives full-circle visibility
- Strong, double-ribbed floor pan has 5 sturdy cross members welded to underside for high rigidity
- Cowl upper and side panels, front door pillars and dash panel are integrated into a single, solid, stronger unit
- New wide hood has extra-strong inner and outer panels hem-flanged and welded into an exceptionally rigid assembly
- New rocker panels, designed for better draining and venting, are firmly secured to front body pillars, wheelhouses and quarter panels for high torsional strength
- Rugged deck lid has inner and outer panels securely flanged and welded for minimum torsional deflection. Inner panel is ribbed for extra stability
- Body structure in the area of the package tray, ribbed wheel-housings and floor pan are welded into a solid one-piece unit for greater durability
- Massive, one-piece front and rear bumpers have shorter support arms for greater trim protection and higher resistance to impact

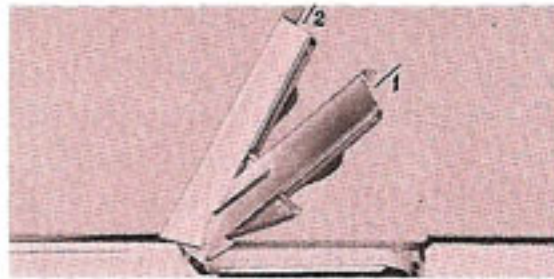

**TWO-STAGE DOOR CHECKS** . . . "offset type" front door hinges with heavier, stronger bolts help swing the door wide-open; 2-position checks hold door  $\frac{2}{3}$ -open or full-open.

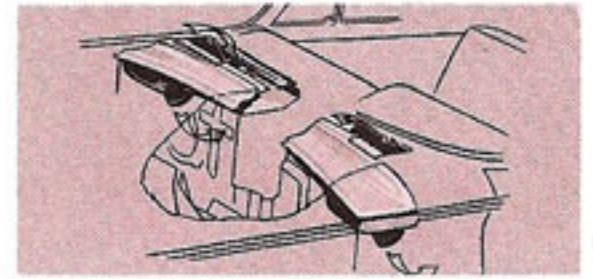

**NEW COWL-AIRE INTAKE** . . . now located at top of the cowl to bring in a high volume of cleaner, fresher outside air with less dust, road fumes, etc.

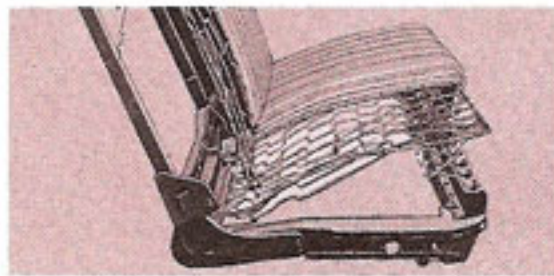

**FOAM-PADDED SEATS** . . . the front seat of the 60 Ford has a thick layer of foam padding over firm, non-sag springs for greater comfort and to reduce driver fatigue. Optional on rear seats.



**NEW SEAT ANCHORAGE** . . . front seat glides on 12 steel balls for easier  $5\frac{1}{2}$ " 11-position adjustment, smoother operation. Positive safety stops in each inclined seat track resist separation from undue force of impact.

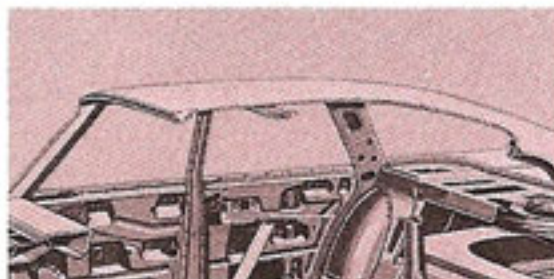

**STURDY ROOF PANEL** . . . is supported by extra-strong pillars and firmly reinforced by double-hat, all-steel cross bracing at center, welded to the box-section roof rails, for high strength and rigidity.

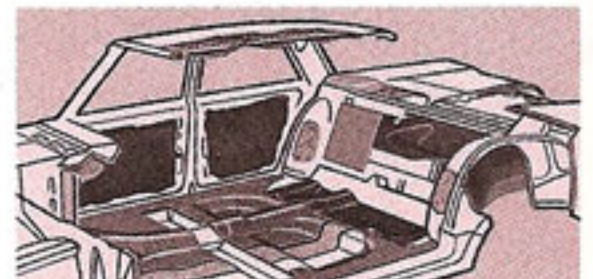

**SPECIAL INSULATION** . . . no car in its price class is as well sound and weather insulated with high-quality materials as the 60 Ford. Extra heavy insulation at critical areas for sound deadening and greater comfort.

# FORD'S NEW 1960 CHASSIS

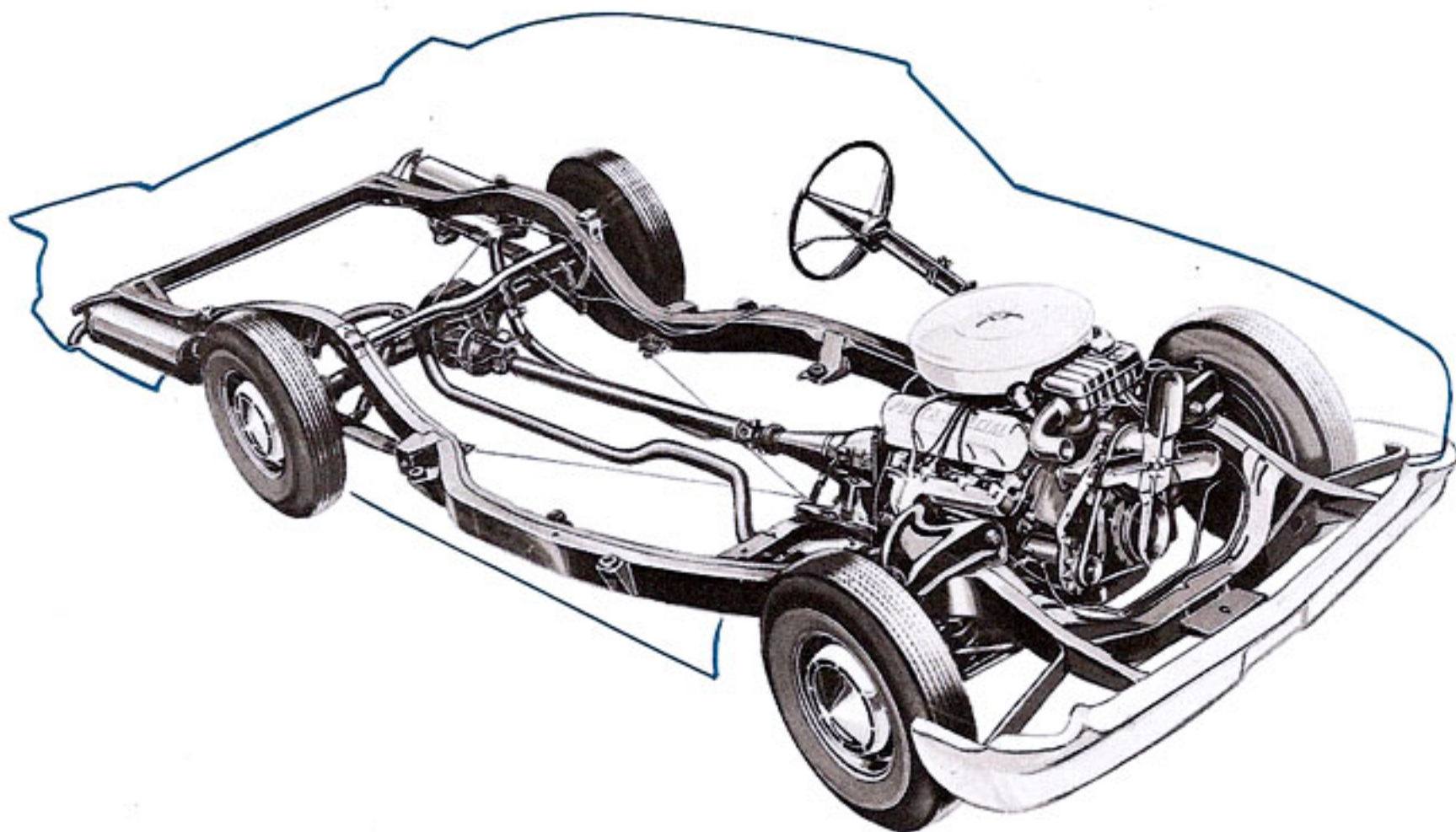

## Solid steel structure for greater safety . . . durability!

The Ford Chassis for 1960 is the brawniest ever built for a Ford car and includes many strength and safety features unmatched by any car in Ford's field. The all-new Inner Ford Body and Chassis combination is the ultimate result of years of engineering, testing and building for maximum durability under the most severe operating conditions. *Ford gives you what you need most to give you the most for your money!*

- Wider and 25% stronger for 1960, Ford's Wide-Contoured frame with 5 enlarged cross members and deeper side rails, provides greater durability and full protection against side impact
- New corrosion-resistant aluminized muffler and integral tailpipe, mounted at rear of frame side rail, is designed for 100% longer life than ordinary kinds
- For super strength, durability and safety, all 1960 Ford tires are made of Tyrex cord
- Large-capacity universal joints have pre-lubricated needle bearings for smoother performance and longer life
- Sturdy tubular driveshaft with deep-offset pinion permits low shaft tunnel height and contributes to more interior foot room
- Exclusive extra-deep-offset hypoid rear axle has straddle-mounted pinion gear for greater rigidity and large gear teeth on both ring and pinion gears for longer life
- Silent-Grip body mounting system with live rubber cushions and pads and with relocated frame brackets increases body-to-frame rigidity, while soaking up road shock and noise
- New body front mounts are yoke-type to permit a more rigid mounting, reduce front-end body movement for a smoother, quieter ride
- New Cross-Flow radiator with separate supply tank and 180° Positive-Action thermostat for more efficient cooling system
- Center-fill, big capacity gas tank holds 20 gallons

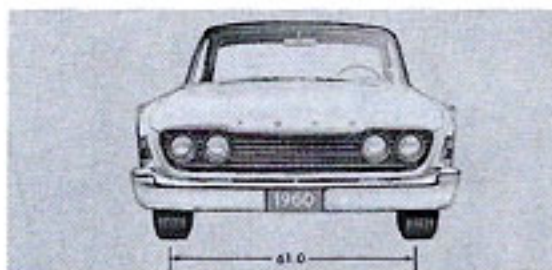

**WIDER FRONT AND REAR TREADS . . .** 61" front and 60" rear treads provide a more stabilized, "flatter" ride with far steadier control and a new feeling of security on cornering. Wide-Tread design gives surer, safer handling and superior roadability.

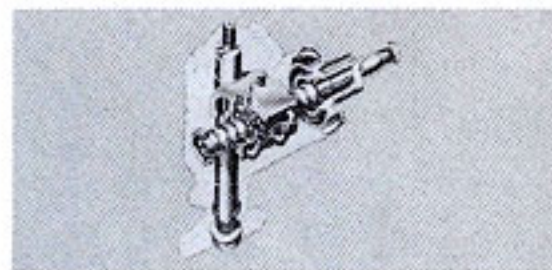

**MAGIC-CIRCLE STEERING . . .** Ford uses a recirculating-ball, low-friction type steering mechanism instead of a conventional worm gear for much easier steering, parking and over-all handling—almost like power steering.

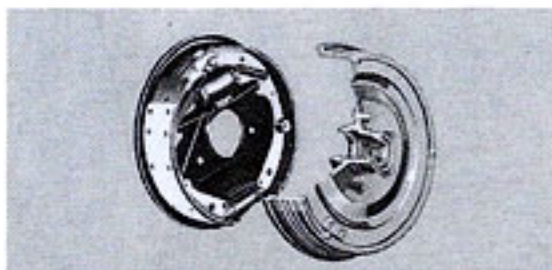

**BIGGEST BRAKES IN FORD'S FIELD . . .** new, wider double-sealed brake drums are externally grooved for faster cooling, less fading, surer stops. Tailored-to-model lining areas have been increased, too, for greater durability.

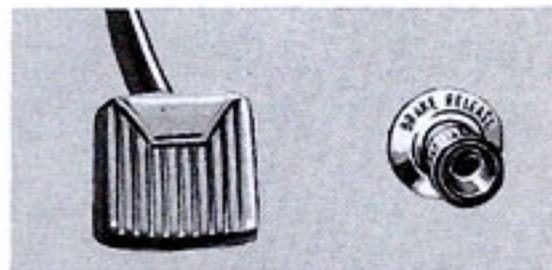

**FOOT-OPERATED PARKING BRAKES . . .** may be set at various "on" positions by merely pressing the handy foot pedal at left of steering column . . . release with convenient new pull-out knob on instrument panel.

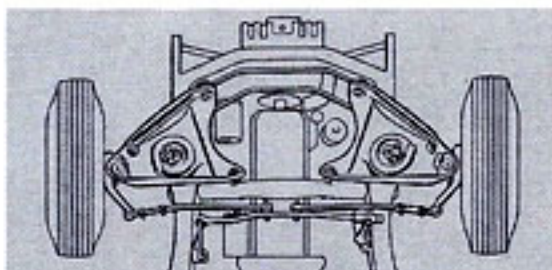

**BALL-JOINT FRONT SUSPENSION . . .** with longer coil springs for a more cushioned ride. Lower suspension arms are swept back 20° so front wheels move up and back over bumps for minimum road shock.

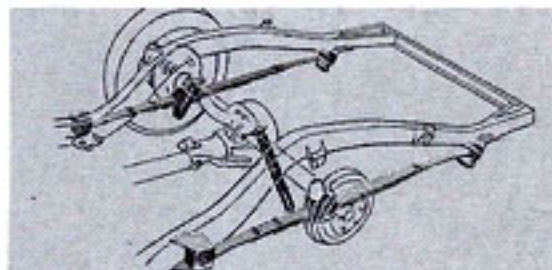

**NEW REAR SUSPENSION . . .** for 1960, you get a new asymmetrical, levelized, variable-rate rear suspension that dampens out bumps and keeps your ride far smoother than is ever possible with coil-type rear springs.



# FORD FACTORY-INSTALLED POLICE CAR OPTIONS

Low-cost extras tailored to your police needs

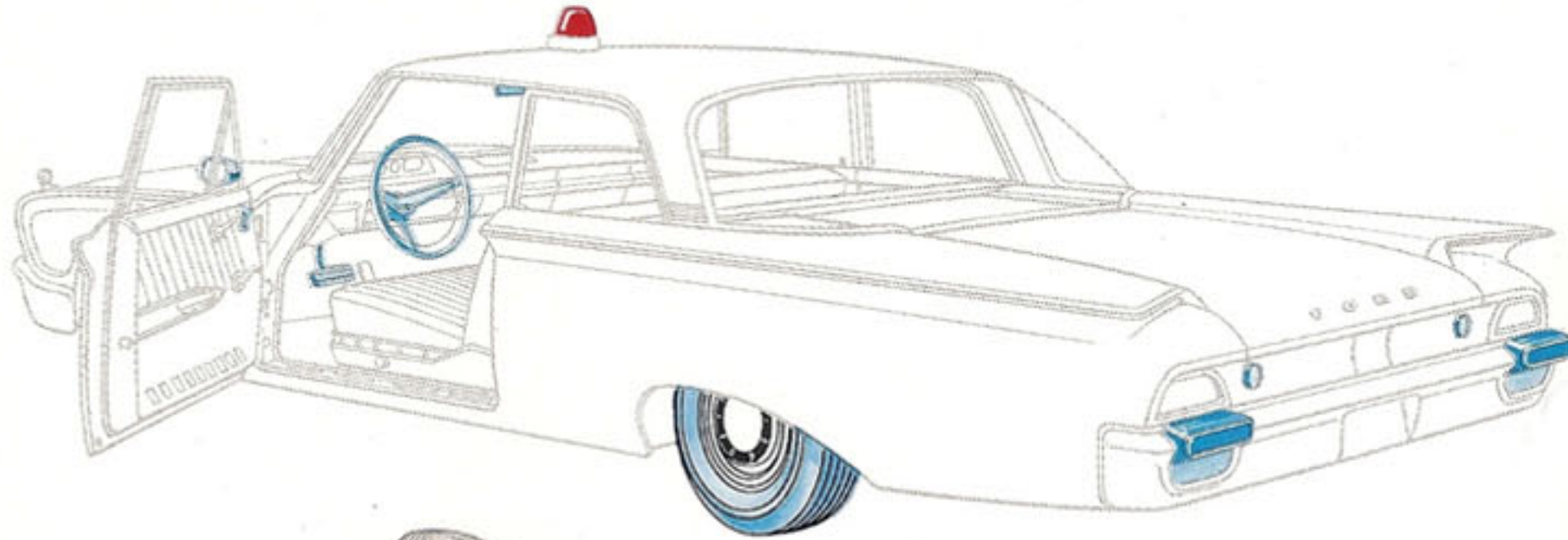

### SPECIAL "ROUND-THE-CLOCK" DUTY FRONT AND REAR SEATS . . .

Have heavy-gauge springs in cushions and seat backs with either cotton or foam padding in cushions for greater comfort and longer life. Washable, extra durable, single-tone beige all-vinyl upholstery and trim, in place of standard upholstery and trim, is also available at slight extra cost.



### NEW EQUA-LOCK DIFFERENTIAL

Delivers the driving force equally to both rear wheels, providing better traction on slippery surfaces. Both wheels turn at same speed, instead of one spinning as the other stands still.

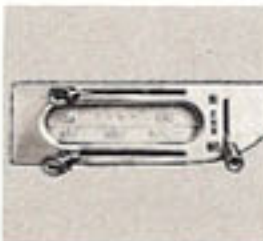

### NEW MAGICAIRE SYSTEM

Increased capacity of Ford's new MagicAire combination heater-ventilator-defroster for 1960 means faster warmth and improved comfort. New dual defroster outlets, with MagicAire's increased capacity, clear a larger windshield area more quickly.



### HEAVY-DUTY 12-VOLT BATTERIES

Have a high reserve capacity to meet all electrical requirements. 55 amp-hr size is standard. Optional are 55 or 70 amp-hr low specific gravity, plus regular 65 or 70 amp-hr types.



### LONGER-LASTING HEAVY-DUTY 11" CLUTCH

Special heavy-duty construction designed to hold up longer in hard police service. Has ball-type release bearing with fitting for pressure lubrication.



### GROOVED BRAKE DRUMS

Heavy-duty brake drums for Fairlane (standard on Station Wagons) are wider, heavier and externally grooved to dissipate heat faster and increase resistance to fade. Larger, 15" wheels also improve air circulation around brake drums and reduce overheating in emergency stops. Lining area is 248.4 sq. in.



### 15-INCH WHEELS

Heavy-duty 15 x 5K wheels provide better cool air circulation and reduce heat build-up at high speeds . . . in combination with 7.10 x 15 nylon tires, there is much greater protection against "heat" blow-outs.



### HEAVY-DUTY SUSPENSION

Ford's optional suspension is similar to the standard design but with stiffer springs and with shock absorbers calibrated for greater damping characteristics. It includes heavy-gauge front coil springs and heavy-duty front shock absorbers for longer life even under the most severe road conditions. These are combined with extra-capacity rear spring leaves and heavy-duty rear shock absorbers, giving automatic adjustment for handling heavy loads with ease, while maintaining a smooth, level ride for driver and passengers.

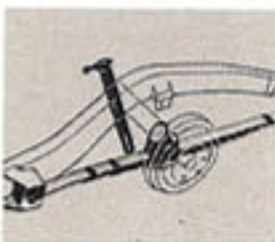

Special Ford factory-installed police car options are so designed as to custom tailor your Ford police car to your *exact* law enforcement needs . . . to furnish every extra *performance, safety and durability* feature needed for peak operating efficiency at all times and under all the extremes of your police duty. There are a wide variety of single options to choose from as well as two low-cost, value-packed combination police car option kits. All options, except as noted, are available for the Fairlane and Station Wagon Series. Ask your Ford Dealer for complete details.

### Exclusive Ford "Lifeguard Design"

You've a wonderful new world of safety in 1960 Ford police cars. *Standard equipment:* Safety-Curved instrument panel with recessed control knobs; Lifeguard deep-dish steering wheel; safety-type seat anchorage; Lifeguard Double-Grip door locks; Lifeguard safety-swivel rearview mirror; Lifeguard front arm rests. *Optional:* Lifeguard super-cushioned instrument panel padding; double-anchored Lifeguard fully cushioned sun visors; Ford nylon seat belts firmly anchored to floor structure; Lifeguard rear arm rests.

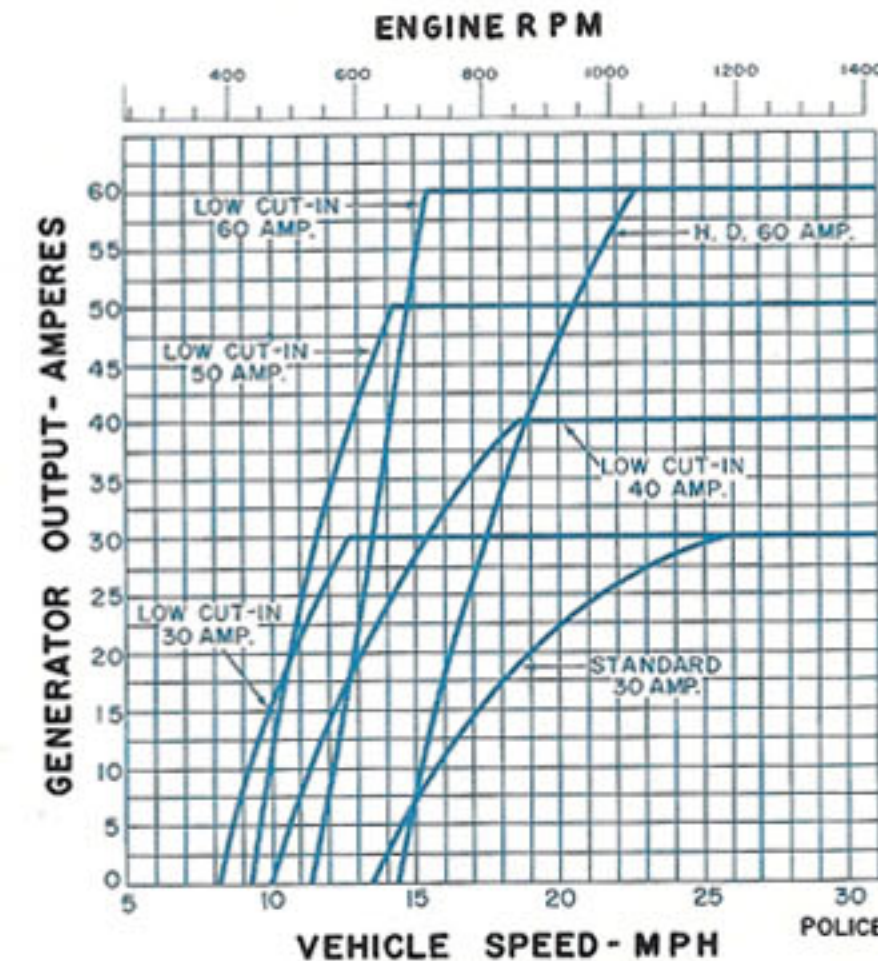

Ford's 12-volt electrical system makes available 30-, 40-, 50- and 60-amp. low cut-in models and 60-amp. heavy-duty units. Use the performance curve chart above to help you select the generator most suitable for your needs. Alternator-rectifier systems in 50-amp. standard or 50-, 60- or 100-amp. heavy-duty are also available.

## ADDITIONAL OPTIONAL EQUIPMENT

AS ILLUSTRATED ON CAR AT LEFT:

- †Red dome roof light (DSO)
- \*Visored spotlight-mirror (DSO)
- Swift Sure Power brakes (RPO)
- Master-Guide power steering (RPO)
- \*Backup lights (RPO)
- \*Inside non-glare mirror (PAO)
- Bumper guards, front and rear (Dealer Installed)
- Rear bumper reflectors (Dealer Installed)
- Nylon tires (PAO)

### OTHER OPTIONS:

#### RPO—Monthly Schedule Items

- \*Radio—Full Tone Manual or Console Range
- \*Recirculating heater and defroster
- \*Self-regulating electric clock
- \*Aquamatic windshield washer-wiper
- I-Rest tinted safety glass (all around)
- Power-Lift door windows (except Business Sedan)
- Power Front Seat
- 4-Way manually operated front seat
- Electric windshield wipers, 2-speed
- Interior Trim Package—color-keyed steering wheel with horn ring, front door switch for dome light, rear arm rests and rear ash tray (for both Ranch Wagon models)

#### PAO—Pre-Approved Items

- Steering wheel with horn ring\*\*
- Ash receptacle in front seat back (4-Door only)\*\*
- Heavy-duty spring suspension
- Extra-capacity radiator
- Radio suppression kit—local use or highway use
- Calibrated speedometer
- I-Rest tinted safety glass (windshield only)
- \*Full-View outside-mounted mirror

#### DSO—Special Order Items

- 1 1/2" I.D. conduit for radio cable
- Ventilation and radio mounting-base in luggage compartment for radio equipment\*\*
- Special map light
- Red blinking sealed-beam spotlight
- Siren and siren controls
- Red flashing lights in front grille and taillights
- Pace Type Speedometer with special needle-stop for pacing, mounted on steering column or instrument panel
- Manual throttle control for Police Interceptor Engine
- Single-key locking system (one key for all locks in fleet)
- \*Visored Full-View, Adjust-O-Ring or Deluxe outside-mounted mirror
- Ceramic fuel filter

#### Dealer Installed Items

- Exhaust deflectors
- Deluxe rear antenna\*\*

†Typical roof light shown—please specify manufacturer of actual light and roof location required  
\*\*Also dealer installed \*\*\*Fairlane only

## AVAILABLE AT LOW KIT PRICES

### 1. REGULAR PACKAGE FOR FAIRLANE 4-DOOR MODEL INCLUDES:

- Standard cloth, or PAO beige, green or red all-vinyl upholstery and trim
- Heavy-duty brakes
- Economy carburetor (Six, with Fordomatic or HD clutch)
- Heavy-duty clutch—except automatic transmission
- Heavy-duty front and rear seats, with cotton pads in cushions (or foam pads at extra cost)
- Heavy-duty front and rear springs with heavy-duty shock absorbers
- "Coarse Pitch" conventional transmission with steel speedometer gears (Six engine only)

### 2. DELUXE PACKAGE FOR FAIRLANE 4-DOOR MODEL INCLUDES NO. 1 PACKAGE PLUS:

- Rear arm rests, ash receptacle in front seat back, and heavy-duty front and rear floor mats

### EXPLANATION OF TERMS

- RPO—regular production option. Available without delay in production.
- PAO—pre-approved option. Available in limited quantities, slight delays possible.
- DSO—domestic special order. Specific procurement with time necessary to fill order.

# 1960 FORD POLICE CAR SPECIFICATIONS

**Exteriors: Fairlans and Station Wagons**—New Diamond Lustre Finishes (that never need waxing) are available in Single Color or in Two Tone combinations. The Single Colors are: Raven Black, Corinthian White, Montecarlo Red, Platinum, Belmont Blue, Skymist Blue, Meadowvale Green, Adriatic Green, Beachwood Brown, Yosemite Yellow, Sultana Turquoise and Aquamarine. Two Tone selections combine Corinthian White top with any Single Color; also Skymist Blue top with Belmont Blue, Adriatic Green top with Meadowvale Green, and Aquamarine top with Sultana Turquoise.

**Fairlane Interiors:** Handsome new blue, green or gray Black Stripe nylon cloth upholstery with harmonizing Morocco Grain vinyl bolsters and trim. A long-wearing optional all-vinyl interior is available in beige on all models, and green or red upholstery and trim on 4-door. Floor covering is Sof-Tred, carpet-textured black rubber.

**Station Wagon Interiors:** Ranch Wagon models come in a choice of attractive blue or green Stripe Thong woven plastic or beige Wicker vinyl upholstery with harmonizing Morocco Grain vinyl bolsters and trim. Country Sedan models provide a choice of rich-looking blue, green or turquoise Dash Pattern woven plastic and beige or red Tweed Print vinyl upholstery with harmonizing Radiant Morocco Grain vinyl bolsters and trim. Passenger compartment floor covering is Sof-Tred, carpet-textured black rubber. Color-keyed ribbed vinyl is placed on load-spaces, tailgate and Foldaway seat back.

**Engines: 145-hp Mileage Maker Six** (available with all transmissions except Cruise-O-Matic)—223-cu. in. displ.; 3.62" bore x 3.60" stroke; 8.4 to 1 comp. ratio; regular fuel; low-silhouette unit-design carburetor; manual choke.

**Optional 185-hp Thunderbird 292 V-8** (available with all transmissions)—292-cu. in. displ.; 3.75" bore x 3.30" stroke; 8.8 to 1 comp. ratio; regular fuel; low-silhouette 2-venturi carburetor, new automatic choke; new wedge-type combustion chambers and smaller intake valves for better fuel economy; Y-type single exhaust.

**Optional 235-hp Thunderbird 352 V-8** (available with all transmissions)—352-cu. in. displ.; 4.00" bore x 3.50" stroke; 8.9 to 1 comp. ratio; regular fuel; low-silhouette 2-venturi carburetor, new automatic choke; aluminized valves with hydraulic lifters and alternate intake-exhaust valve placement for longest life; Y-type single exhaust.

**Optional 300-hp Police Interceptor 352 Special V-8** (available with all transmissions except Fordomatic)—352-cu. in. displ.; 4.00" bore x 3.50" stroke; 9.6 to 1 comp. ratio; premium fuel; low-silhouette 4-venturi carburetor, new automatic choke; higher efficiency centrifugal-vacuum spark control; aluminized valves with hydraulic lifters, special dual valve springs and solid keepers for more positive, dependable action at high speeds; alternate intake-exhaust valve placement for longest life; special camshaft for high-speed engine operation; crankshaft is precision-molded with large journal overlap, copper-lead main (five) and connecting rod bearings; dual exhausts.

**Engine Features:** For greater economy and longer life, all Ford engines have Short Stroke, low-friction design; Deep-Block construction; Free-Turning overhead intake and exhaust valves (except Police Interceptor); new Super-Filter air cleaner with reusable element; new high-capacity in-line fuel filtering system and combination fuel and vacuum-booster pump for more constant windshield-wiper

action; new 2-phase Full-Flow disposable-type oil filter; new Thunderbird-type Cross-Flow cooling system with separate top reserve tank and 180° Positive-Action thermostat; 12-volt electrical system; weatherproof ignition with new Static-Ban constant resistance wiring; triple-seal 18-mm. Turbo-Action spark plugs; 78-plate, 65 amp-hr battery with Police Interceptor V-8 and automatic transmission, 66-plate, 55 amp-hr battery with others; new full-wrap-rubber rear engine mount; new aluminized muffler with integral tailpipe mounted at rear of frame. All V-8's electronically balanced while operating under their own power for extra smoothness.

**Clutch and Manual Transmissions: Standard Clutch** is of semi-centrifugal design with full-weighted levers for more positive engagement. Face diameter and total frictional area: 9½" —85.22 sq. in. with Six, 10½" —96.21 sq. in. with 292 V-8, 11" —113.1 sq. in. with Police Interceptor V-8 and Thunderbird 352 V-8. Suspended pedal linkage, with adjustable over-center assist spring, has new self-lubricating type plastic bushings. **Optional Heavy-Duty Clutch** of 11" diameter has pressure lube fitting for ball-bearing release bearing; needle-roller bearings in release lever fulcrum points; higher-capacity pressure plate springs; extra-thick facings with 123.7 sq. in. frictional area. Choice of ball-bearing or bronze-bushing type pilot bearing.

**Conventional Drive** has 3 forward speeds and 1 reverse, with shot-peened helical gears for high strength and quietness; forged bronze synchronizers. Tailored-to-engine ratios (to 1): **Six** (standard)—1st 3.09, 2nd 1.92, direct 1.00, rev. 3.67; (optional, with coarse-pitch gears)—1st 2.78, 2nd 1.61, direct 1.00, rev. 3.38; **292 V-8**—1st 2.78, 2nd 1.61, direct 1.00, rev. 3.38; **both 352 V-8's**—1st 2.37, 2nd 1.51, direct 1.00, rev. 2.81. **Overdrive** (optional) is above 3-speed plus an automatic 4th gear that cuts in above 27 mph, cuts out below 21 mph (approx.). Downshift to direct by flooring accelerator. Lock-out control on instrument panel. Tailored-to-engine ratios (to 1): **Six and 292 V-8**—1st 2.80, 2nd 1.69, direct 1.00, OD .70, rev. 3.80; **both 352 V-8's**—1st 2.49, 2nd 1.59, direct 1.00, OD .72, rev. 3.15.

**Automatic Transmissions** (Optional): Torque converter in combination with compound planetary gear set. Effective engine braking in "L" position. Water cooled. Selector lever on steering column, illuminated quadrant. **Fordomatic Drive** (for all engines except Police Interceptor V-8) features simplified design, light weight and minimum servicing. Two forward gear ratios, one reverse (to 1): low 1.75, direct 1.00, rev. 1.50; converter (stall) 2.6 with Six and 292 V-8, 2.5 with Thunderbird 352 V-8. In "D" range gives brisk, smooth starts in low. New, durable cellulose clutch plates for satin-smooth upshift. Selector sequence P-R-N-D-L. **Cruise-O-Matic Drive** for all V-8's features two selective drive ranges: "D1" starting in low for all normal driving, "D2" starting in intermediate for more sure-footed driving on slippery surfaces. Three forward gear ratios, one reverse (to 1): low 2.40, intermediate 1.47, direct 1.00, rev. 2.00; converter (stall) 2.1. New 12" converter and increased stall speed result in even greater responsiveness without compromising fuel economy. Selector sequence P-R-N-D2-D1-L.

**Rear Axle:** Semi-floating type with deep-offset hypoid gears. Straddle-mounted drive pinion. Optional heavy-duty axle for Station Wagons has higher capacity shafts and wheel bearings. Ratios (to 1) are tailored to engines and transmissions as follows:

Models	3-Speed	Over-drive	Fordomatic	Cruise-O-Matic
<b>Fairlane</b>				
Six	3.56	3.89	3.56	—
292 V-8	3.56	3.89	3.10	3.10
352 V-8	3.56	3.56	2.91	2.91
Interceptor V-8	3.89	3.89	—	3.10
<b>Station Wagons</b>				
Six	3.89	3.89	3.56	—
292 V-8	3.89	3.89	3.56	3.56
352 V-8	3.56	3.56	3.10	2.91
Interceptor V-8	3.89	3.89	—	3.10

Optional Equi-Lock differential ratios (to 1) are same as above, except 3.56 with Interceptor V-8 and 3-Speed or Overdrive, and 3.10 with Thunderbird 352 V-8 and automatic transmissions.

**Wide-Contoured Frame:** Longer, wider box-section design with 5 cross members and deeper side rails having 25% higher strength and rigidity. Side rails extend outside passenger area, for better foot room and increased side protection. Silent-Grip body mounting system.

**Front Suspension:** Swept-Back, Angle-Poised Ball-Joint type with longer coil springs and larger rubber bushings in lower arms for softer ride. Threaded, permanently lubricated bushings in upper arms. Front end has link-type, rubber-bushed ride stabilizer on Six wagons and all V-8 models. Internally mounted hydraulic double-acting shock absorbers. Heavy-duty suspension optional.

**Rear Suspension:** All-new, asymmetrical, variable-rate design with rear axle located well forward from center of springs for anti-dive and anti-squat control on braking and acceleration. Extra-long, gentle-rate, leaf-type springs with wide spring base provide a softer, more stable, levelized ride. Outboard mounted. Tension-type shackles. Axle nose bumper. Diagonally mounted hydraulic double-acting shock absorbers. Heavy-duty suspension optional.

**Steering:** Magic-Circle low-friction recirculating-ball type steering gear provides easy handling. Protective rear mounting. Anti-friction bearings throughout. Symmetrical linkage. Over-all ratio 27 to 1, with power steering 25 to 1. Lifeguard 3-spoke, deep-center steering wheel.

**Brakes:** All-new Truck-Size double-sealed, self-energizing hydraulic brakes have suspended pedal, dash-mounted master cylinder. Heavier, wider, grooved 11" diameter composite drums with wider riveted linings result in longer life, cooler operation and greater fade resistance. Lining area is 225.6 sq. in. on Fairlane, 248.4 sq. in. on Station Wagons (also all models with Interceptor V-8). Foot-operated parking brake with new pull-out release on instrument panel. Optional Swift Sure power brakes have special low pedal and power reservoir tank.

**Tires:** 4-ply, black, tubeless with Tyrex cord. Safety-type rims. **Fairlane:** 7.50 x 14 on 5" rims with Six and 5½" rims with 292 V-8; 8.00 x 14 on 5½" rims with 352 V-8; 7.10 x 15 nylon on 15 x 5K wheels with Interceptor V-8. **Station Wagons:** 8.00 x 14 on 5½" rims with Six, 292 V-8 or 352 V-8 (optional 6-ply tires recommended with HD axle and HD suspension); 7.10 x 15 nylon on 15 x 5K wheels with Interceptor V-8.

**Dimensions:** 119" wheelbase on all models; wide treads, 61.0" front, 60.0" rear. Over-all length 213.7". Over-all width 81.5". Height (maximum with design load) 55.0" for Fairlane, 56.5" for Station Wagons.

**Prices:** All Power Assists, Optional Equipment and Accessories as well as some of the items illustrated or referred to in this folder are at extra cost. For the price of the model equipped as you desire, see your Ford Dealer.

Comparative information in this folder was obtained from authoritative sources, but is not guaranteed. The specifications contained herein were in effect at the time this folder was approved for printing. Ford Division of Ford Motor Company reserves the right to discontinue models at any time, or change specifications or design without notice and without incurring obligation.



The new Ford Quality Audit system, a Ford first, results in products of highest quality. Quality Audit teams select samples from each shift at every assembly plant for an exhaustive search for any deviations from strict quality standards. This enables assembly operations to check and adhere to this quality control at all times.



FORD DIVISION, *Ford Motor Company*