

*Easiest Car in the World to Own*



*Ford Falcon*

**THE NEW-SIZE FORD**

# Falcon . . . so easy to drive . . . so easy to own!

The New-size Ford is the most *talked about* car since Ford introduced its famous Model A in 1927. And it's easy to see *why!* Here's a car sized to handle and park like a "small" car . . . powered to pass and climb like a "big" car . . . and built like *no* other car for savings!

It gives you up to 30 miles per gallon on regular gas. And you save still *more* on oil, mufflers, and parts. The Falcon is built in Dearborn, Michigan, automotive capital of the world. It's designed to cruise America's highways easily and safely mile-after-mile-after-mile.

And the 6-passenger Falcon is the world's most *experienced* new car. It was driven over every mile of numbered Federal Highway in Experience Run, U.S.A.—a grueling demonstration climaxing Ford's 3 years and 3 million miles of testing and development. It's built to "take it"!

The best news of all about Falcon, though, is this: its savings begin with its low, *low* price! It's the easiest car in the world to own!



**2**-door Falcon with its small turning circle is easy to park . . . easy to drive! Created in the classic tradition of Ford, its beautifully proportioned lines give it stunning beauty. And its new

6-cylinder engine is *up front* for safety and stability. Also, you can forget about power brakes and power steering. You simply don't need them in this New-size Ford. Drive one and see for yourself!

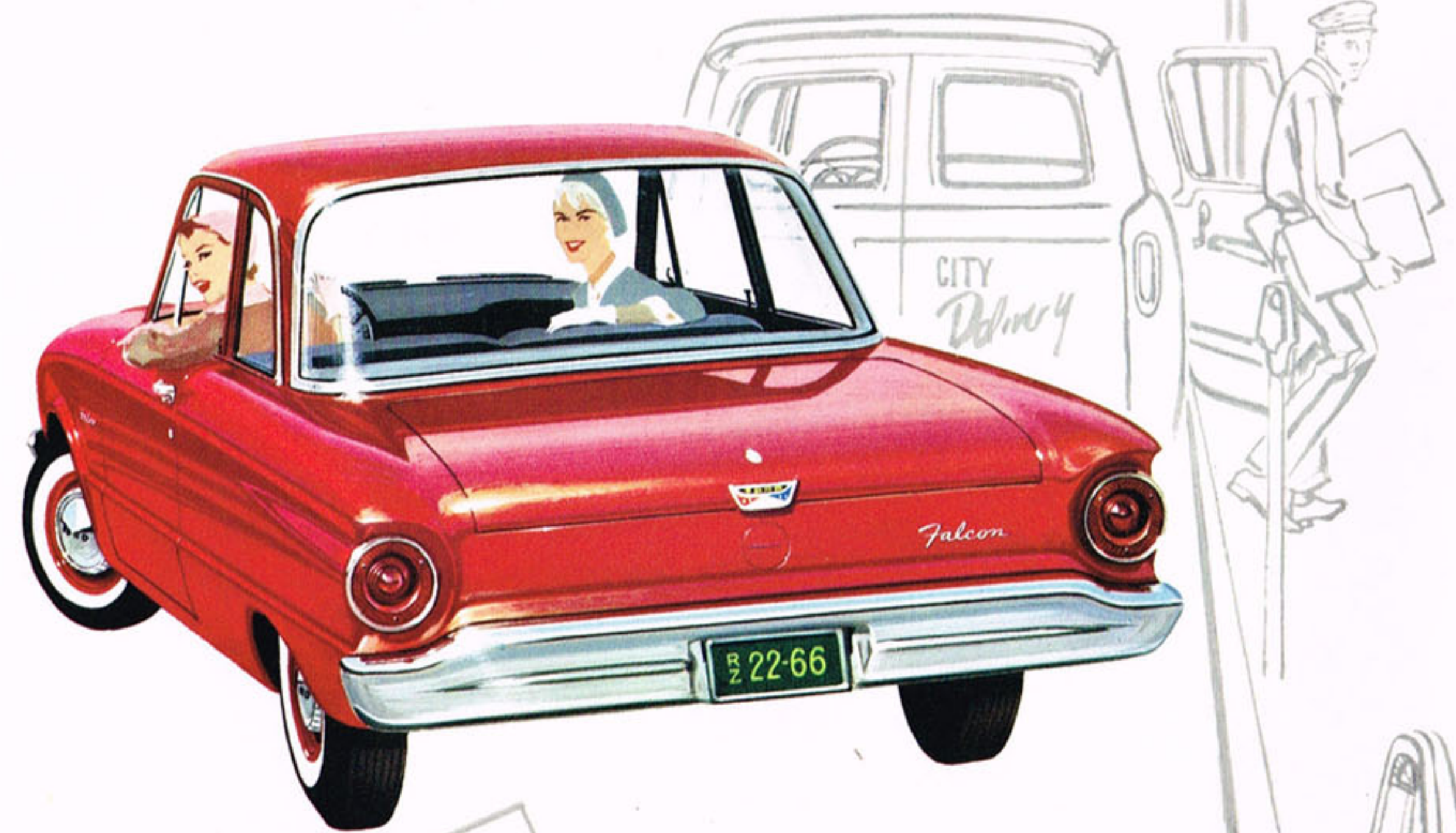

World's most experienced new car



Built in America the Falcon Tudor is powered, sized to cruise U.S. turnpikes easily and safely.

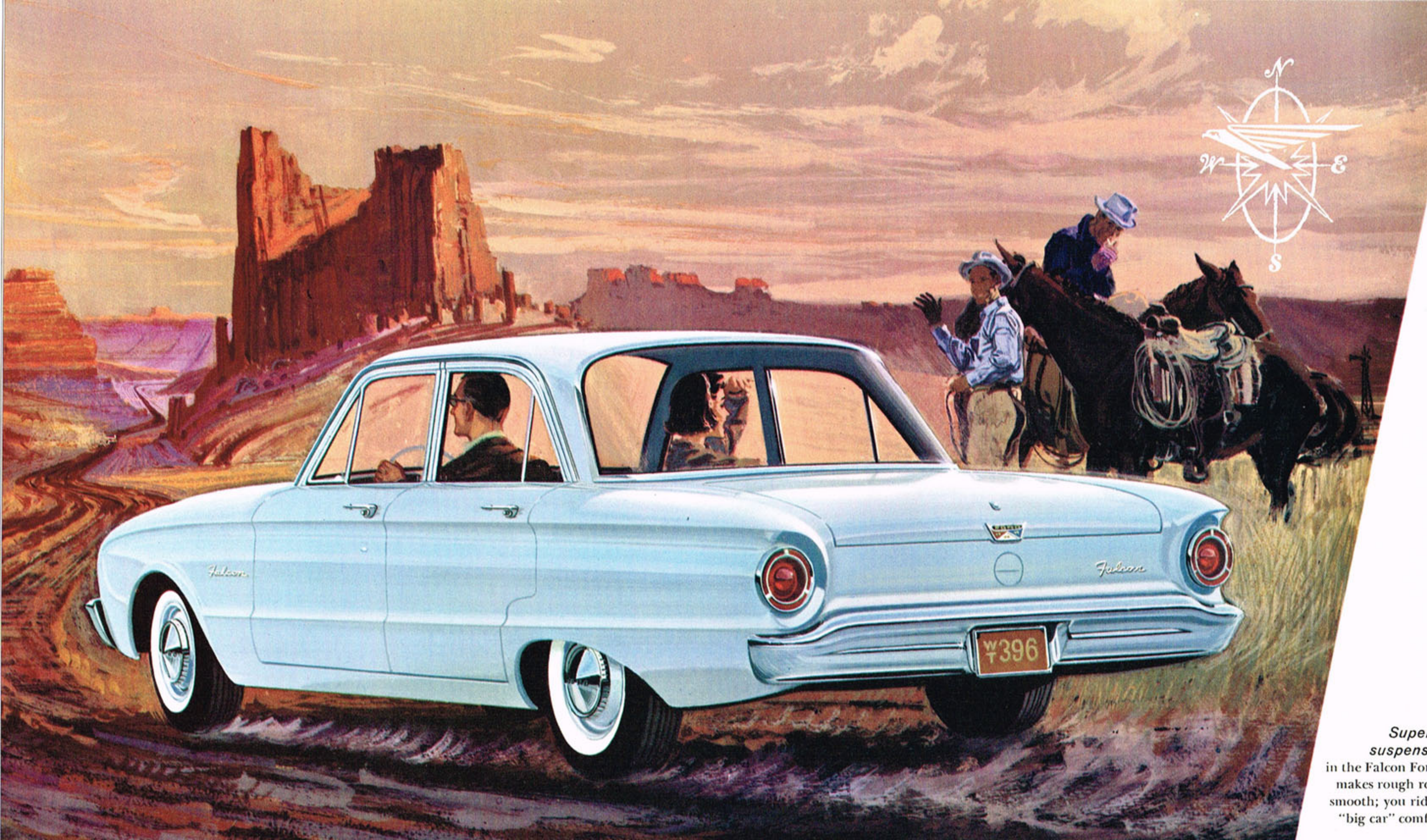

*Superior suspension in the Falcon Fordor makes rough roads smooth; you ride in "big car" comfort!*

World's most experienced new car

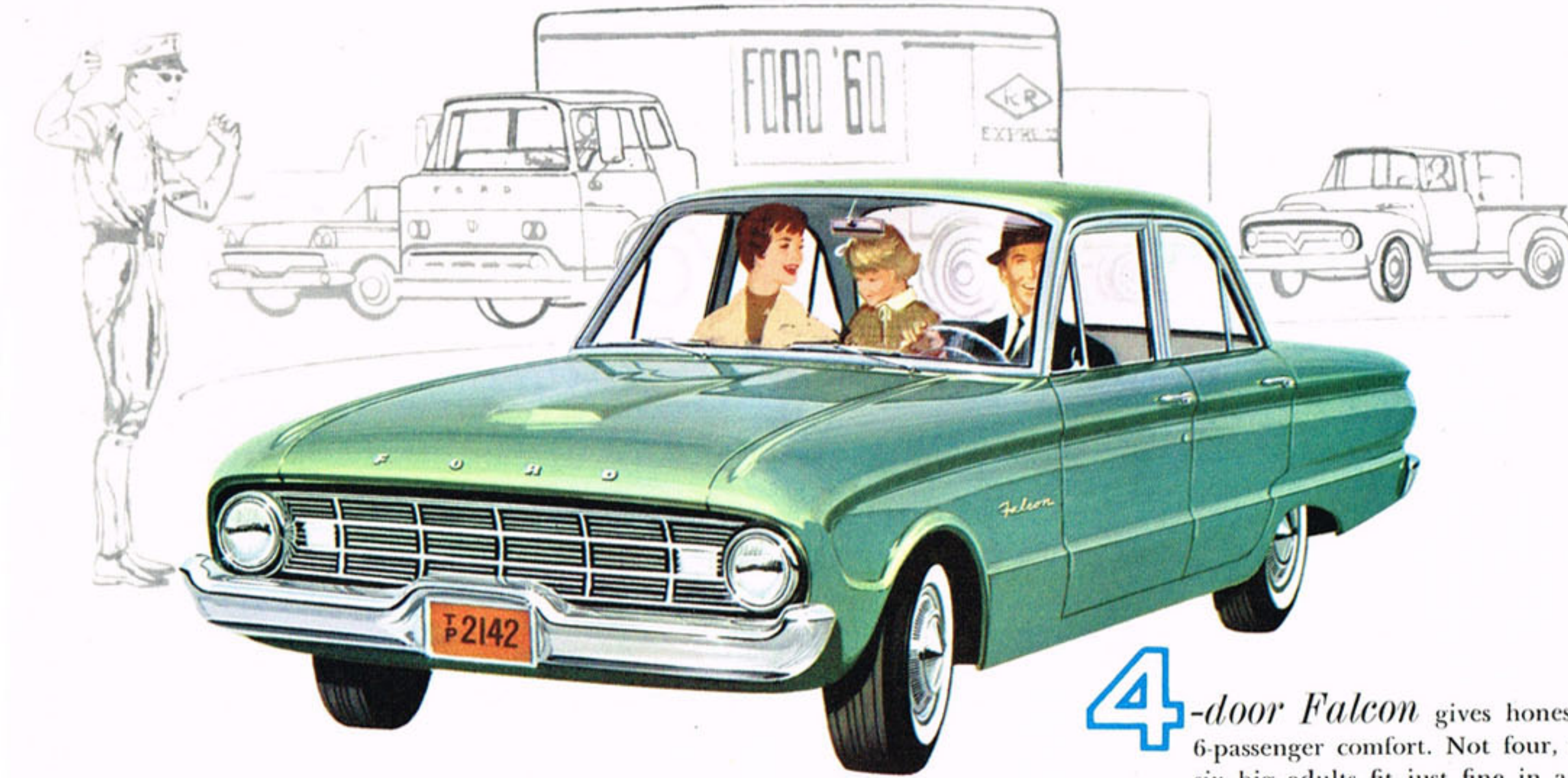

**4**-door Falcon gives honest-to-goodness 6-passenger comfort. Not four, not five, but six big adults fit just fine in a planned-for-people Falcon. And it's easy to get in or out, too. The Falcon's wide doors open fully, and

there's no annoying "dogleg" at the windshield pillar. Finally, there's plenty of trunk space (23 cubic feet) for your luggage. This is more than 2½ times as much trunk space as you get in the best-selling imported car!

*Sports-car agility . . . with a big-car ride!*

Prepare for the biggest surprise of your automotive life the very *first* time you drive a Falcon. For here is a car that accomplishes the "impossible": gives you the handling and agility of a sports car . . . *and* the ride and comfort of a big car.

The secret of the Falcon's smooth ride is in its suspension. Rear suspension is of asymmetrical design. It works with a new type of simplified front suspension to minimize harshness, improve stability, provide anti-dive control. By a special mounting of front springs and shocks, impractical on heavier cars, the Falcon driver is made to feel like he is actually *part of the car!*

Drive one of these new Falcons *yourself!* Only then can you understand what we mean when we say: Falcon gives you sports-car agility . . . with a big-car ride!

The cluster on Falcon's beautiful instrument panel is lighted and all controls are identified.



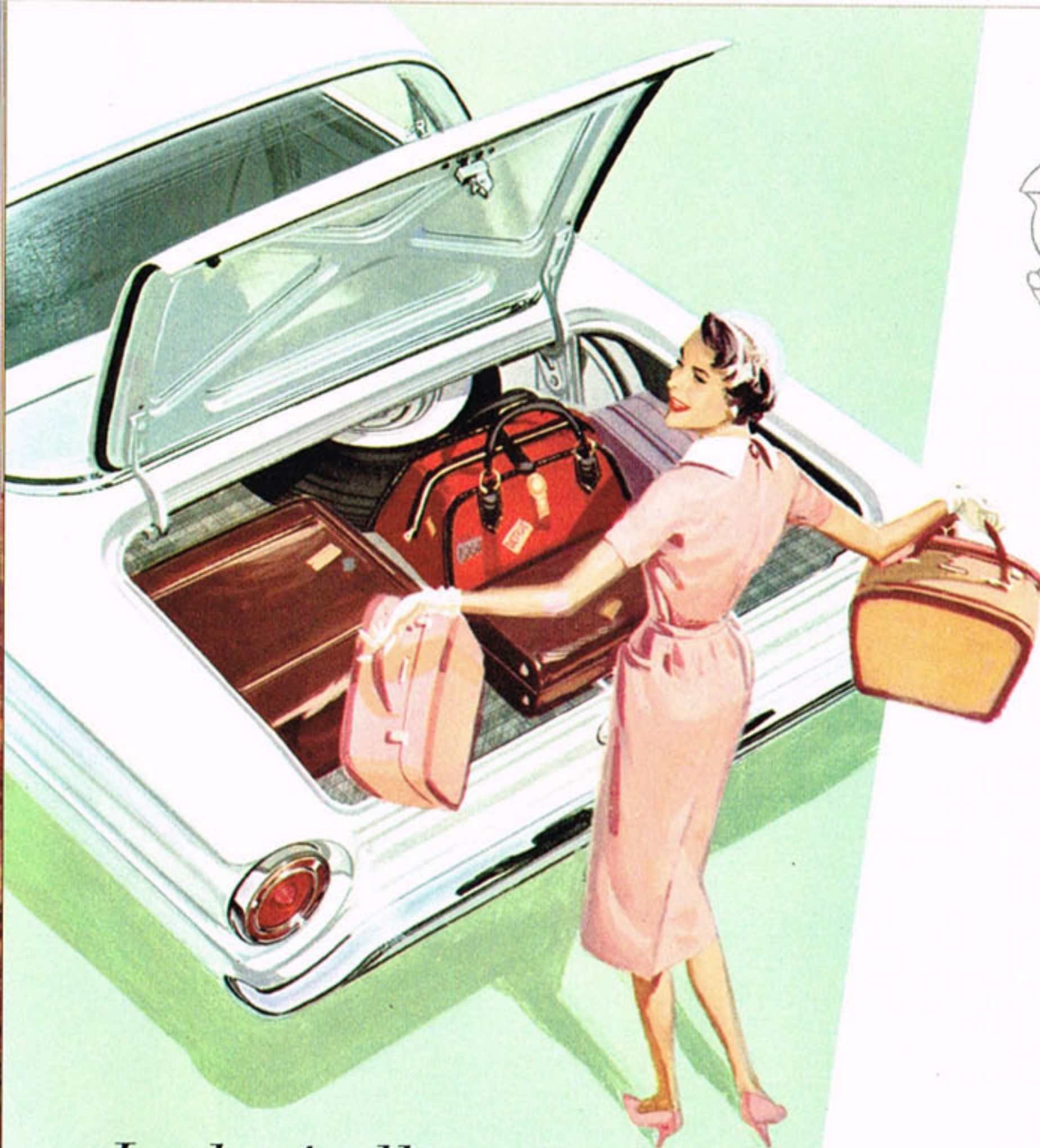

*Look at all  
the trunk room!*

Because its engine is up front, the Falcon gives you 23 cubic feet of usable trunk space! It's big enough to tote luggage for six passengers with room to spare. Because of its broad, low-level entrance, it's far easier to load or unload than some other cars whose trunk is under the hood.

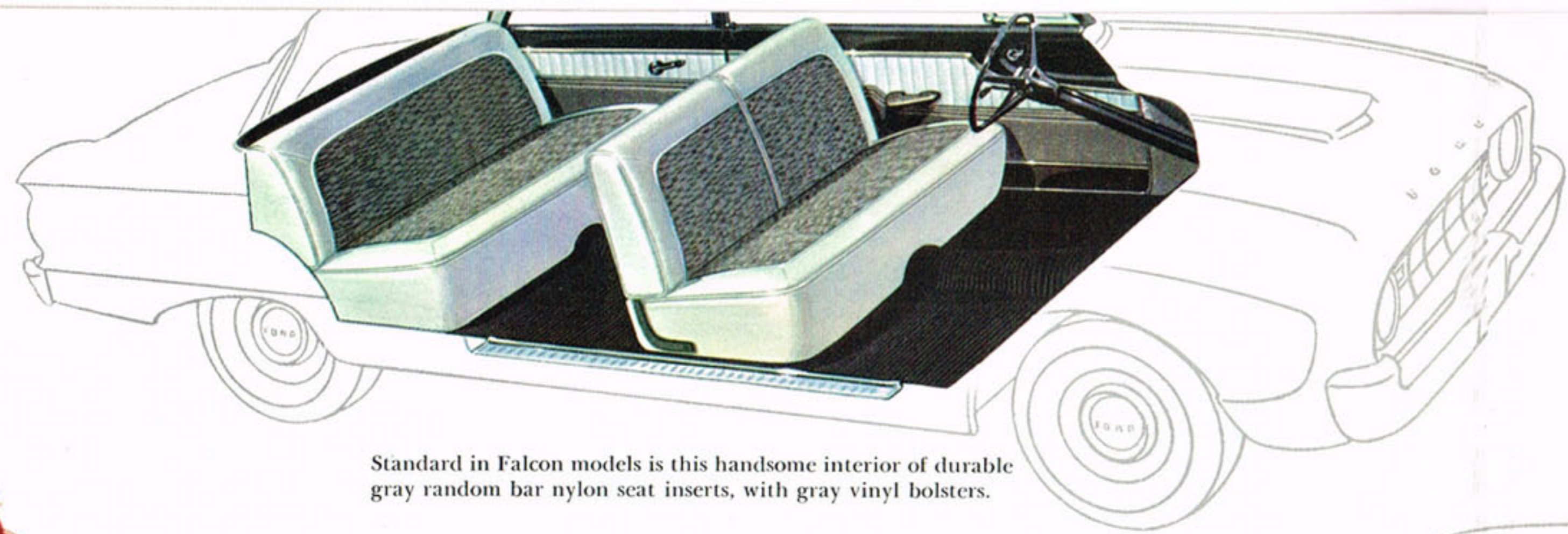

Standard in Falcon models is this handsome interior of durable gray random bar nylon seat inserts, with gray vinyl bolsters.

*Luxurious **Falcon** interiors  
are unequaled in the field*

Ford pioneered the *first* color-keyed interiors ever offered in the low-price field. Since that time Ford's Luxury Lounge interiors have become world renowned for beauty, good taste and durability. Small wonder that in the fashion field to have a "Ford" means to have a "hit"! Shown on this page are just two of the Luxury Lounge interiors available for your new Falcon!

Optional in Falcon models is this deluxe interior (right) with seat inserts of pleated blue tweed nylon and blue vinyl bolsters.

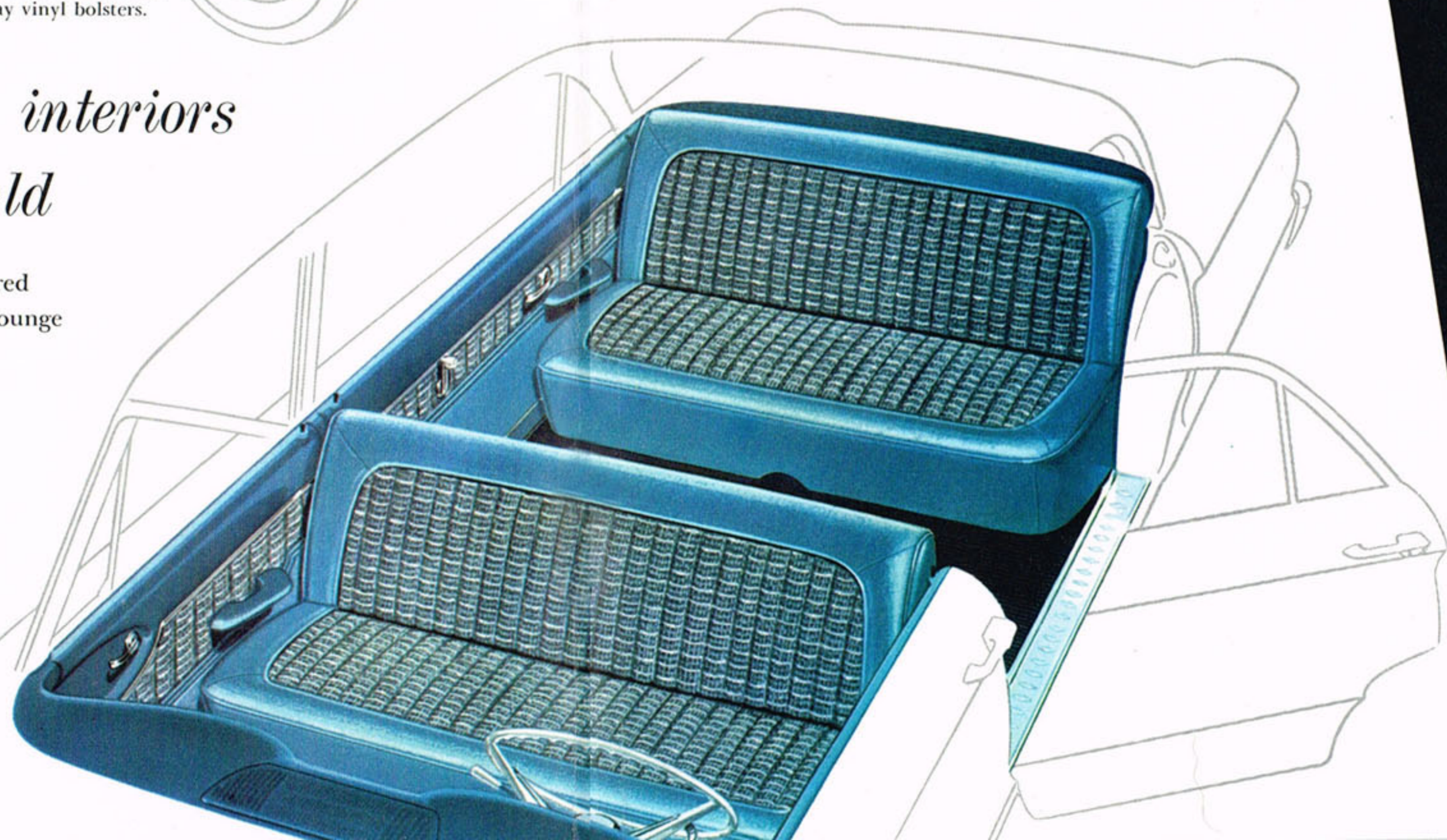

World's most experienced new car



Falcon's Diamond Lustre Finish is the most durable finish on any car today. It requires no "hand-finishing" to bring out natural lustre. And it never requires waxing! Take your pick of colors shown above. With deluxe upholstery, Sultana Turquoise is also available.

STANDARD RANDOM BAR PATTERN

DELUXE GREEN TWEED PATTERN

*...AND LUXURY LOUNGE INTERIORS*



DELUXE BLUE TWEED PATTERN

DELUXE GRAY TWEED PATTERN

Falcon interiors are of long-wearing nylon fabrics. They're as rich-looking as they are durable. And seats are trimmed with morocco grain vinyl for a brighter appearance. Find the Luxury Lounge interior most pleasing to your eye from the swatches shown above!



World's most experienced new car



Up to 30 m.p.g. on regular gas

The all-new Falcon 6-cylinder engine was designed specifically for the Falcon. It thrives on regular gas, delivers up to 30 miles per gallon!



Foam seat padding

Driving on long trips you'll appreciate the foam seat padding that the easy-riding Falcon provides at no extra cost!

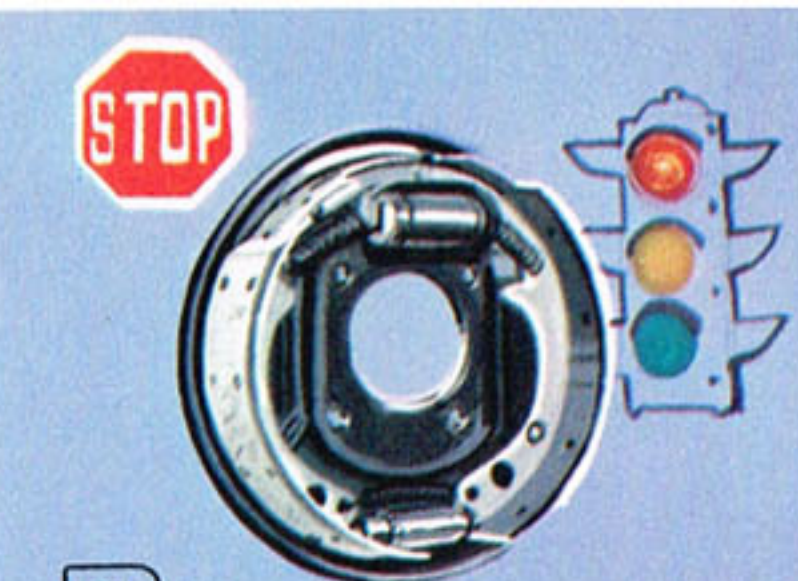

Brakes so good there's no need for power brakes

Sample the Falcon's stopping power and you'll quickly agree there's no need for power brakes. Just touch and whoa!

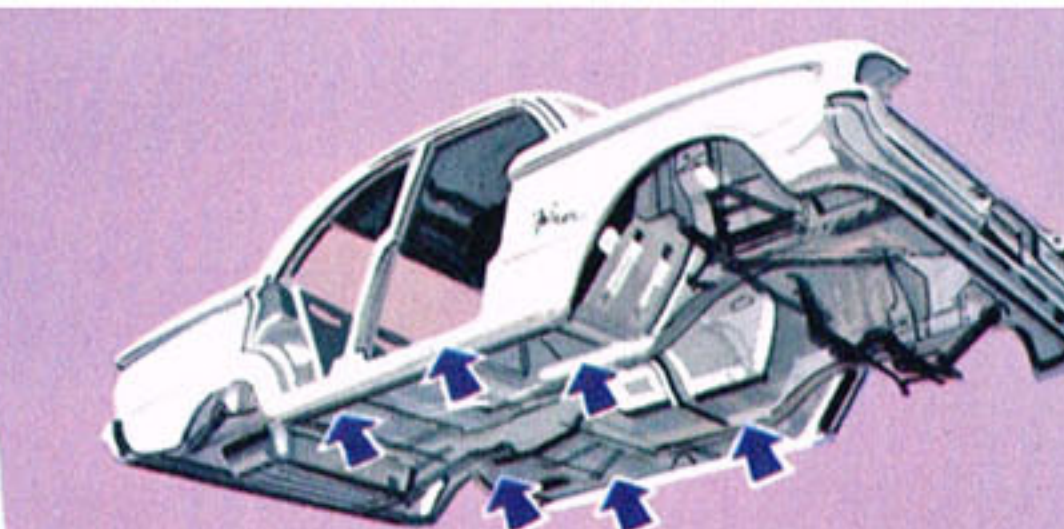

Single-Unit body...with Zinclud Coating

Falcon's Single-Unit Body gives you a quieter, safer, more solid body. Zinclud Coating of main underbody structural members resists rust and corrosion.

How Ford designed the *Falcon* to seat six comfortably...in a far smaller car

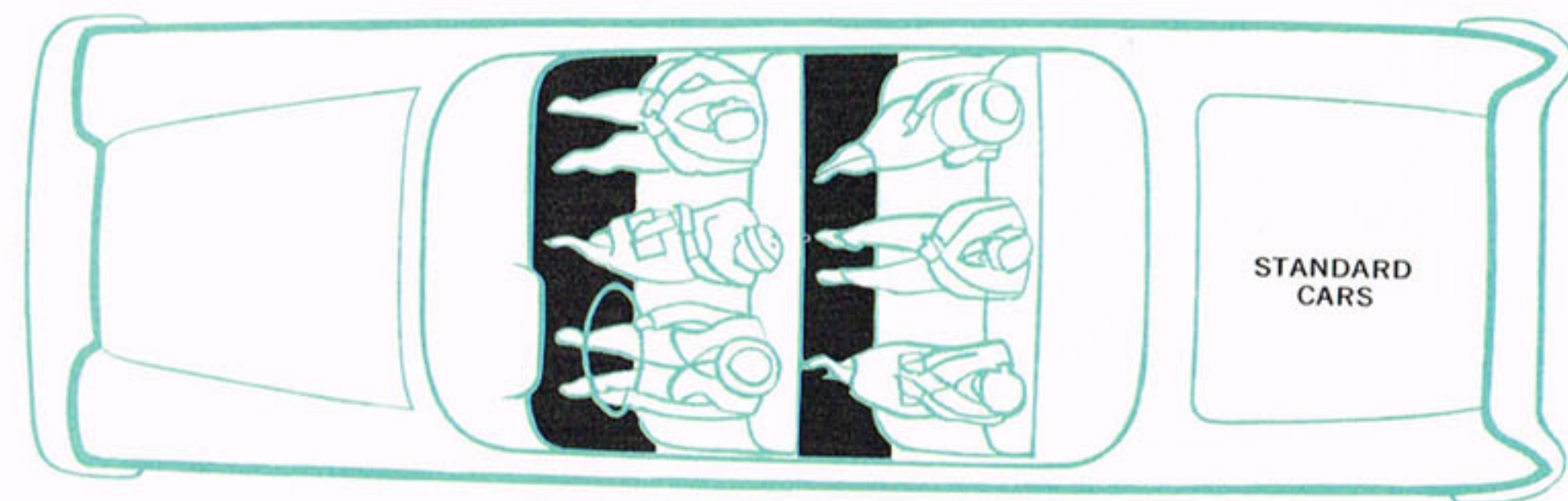

STANDARD CARS

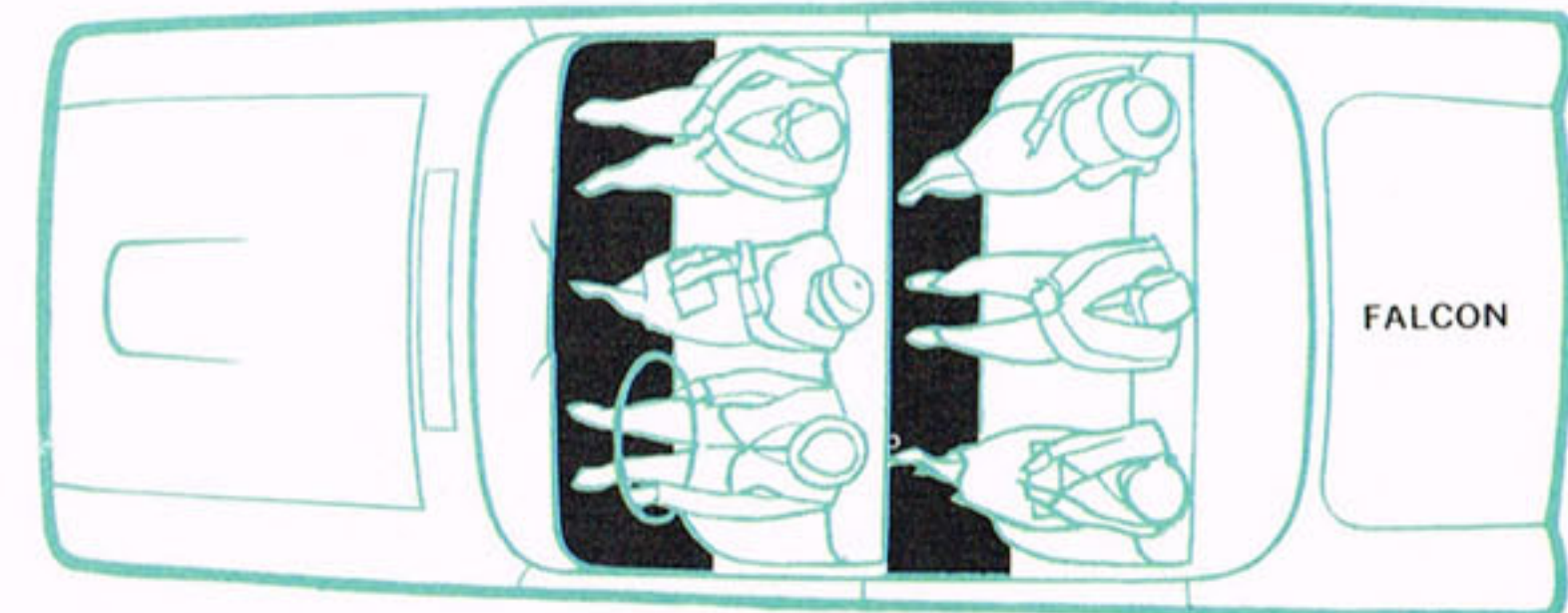

FALCON

There's room aplenty for six big people inside a Falcon. There's room for shoulders, hips, legs and knees... plus plenty of head room, too!

How did Ford accomplish this? How was it possible to design a car with a full-size passenger compartment in a vehicle only 181.2 inches in over-all length?

The illustrations at the left show you how it was done.

Ford engineers used functional styling and single-unit body design in planning this car. They eliminated every inch of waste space. They shortened the hood and deck to reduce overhang. At the same time, they kept the passenger-compartment full-size.

Their success made possible the fabulous Falcon, the new-size car that gives you honest-to-goodness 6-passenger room and comfort... in a far smaller car!

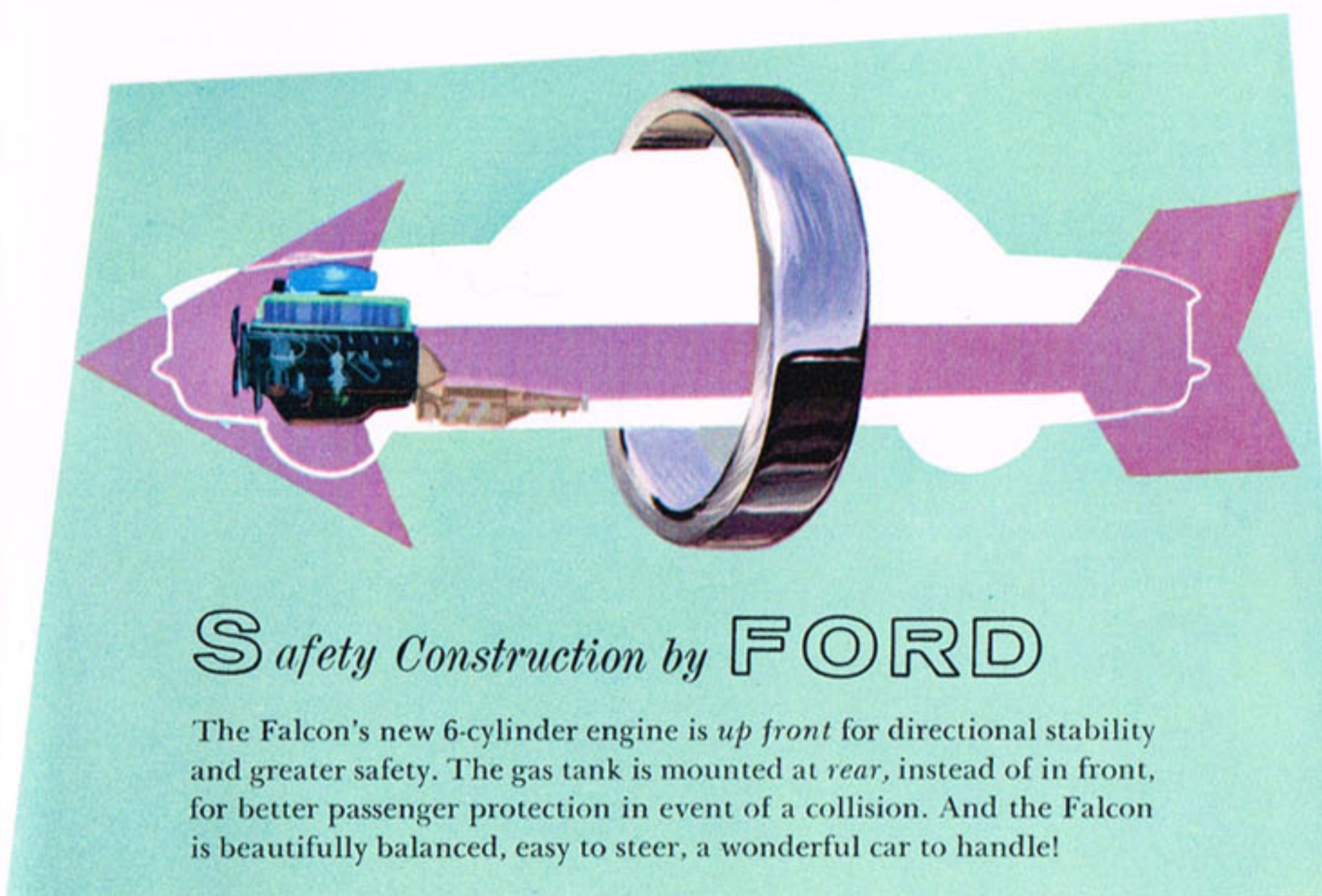

Safety Construction by FORD

The Falcon's new 6-cylinder engine is up front for directional stability and greater safety. The gas tank is mounted at rear, instead of in front, for better passenger protection in event of a collision. And the Falcon is beautifully balanced, easy to steer, a wonderful car to handle!

These features make *Falcon* your best buy!



Short turning

It's easy to turn a Falcon around because of its small turning diameter. Falcon turns in 38 feet; ordinary cars need 41 to 43 feet.

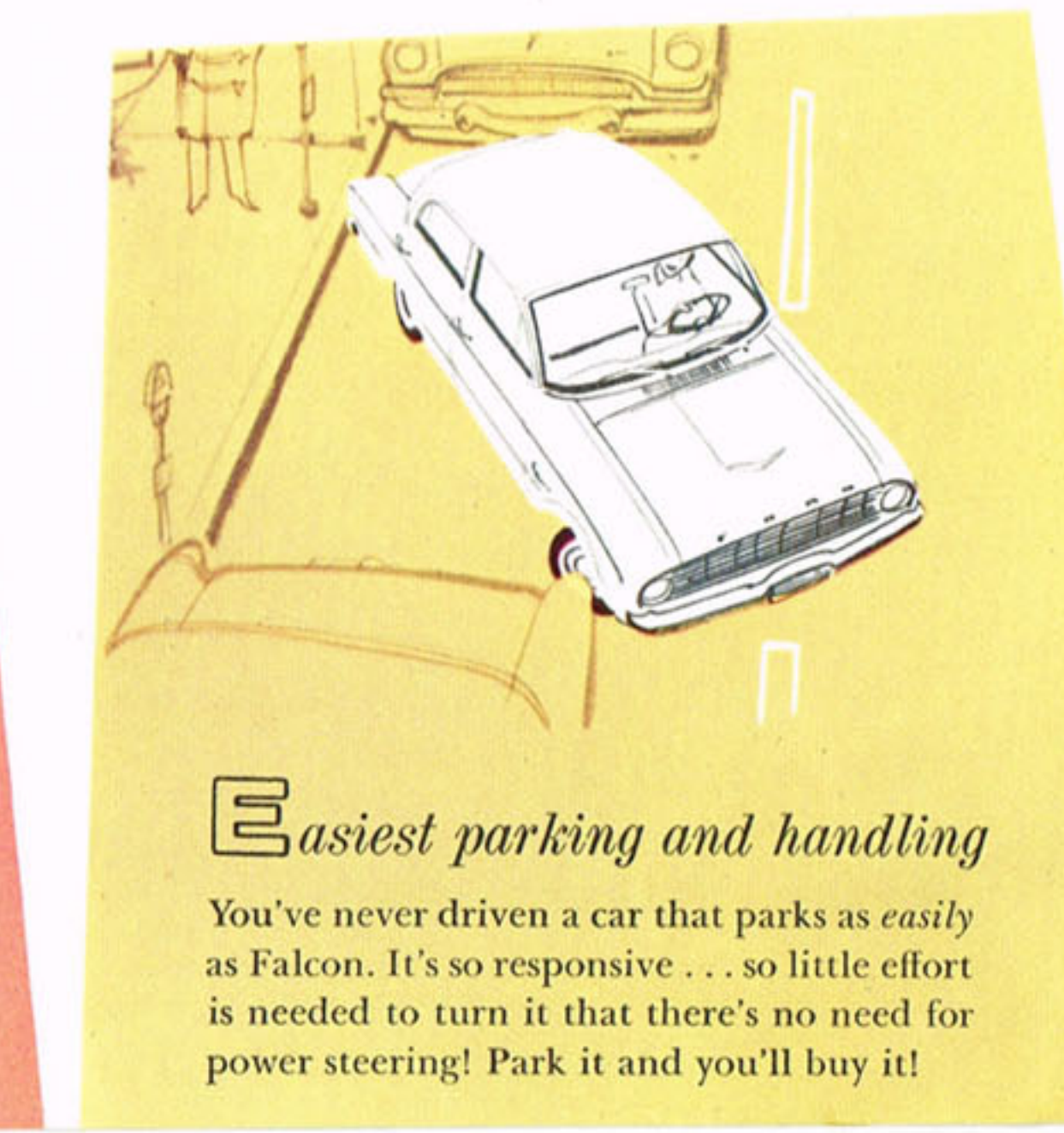

Easiest parking and handling

You've never driven a car that parks as easily as Falcon. It's so responsive... so little effort is needed to turn it that there's no need for power steering! Park it and you'll buy it!



Besides safer construction, the Falcon brings you Ford's exclusive Lifeguard Design. Shown above: *Lifeguard sun visors*, fully cushioned with super shock-absorbing material.\* *Lifeguard padding* on instrument panel for vital protection of passengers up front.\*

## Safer Construction...Lifeguard Design, too!



Other Falcon Lifeguard features include: **1. Lifeguard arm rests** fully cushioned with shock-absorbing material. **2. Seat belts** help keep you in your seat in case of impact.\* **3. Lifeguard deep-center steering wheel** with three equally spaced spokes. **4. Lifeguard Jr. safety locks** help prevent "small fry" from accidentally opening a rear door.\* **5. Lifeguard Double-Grip door locks** for added protection against doors springing open upon impact.

\*Optional at modest extra cost



**Fresh-Air Heater** brings in a continuous supply of air through cowl from outside. Unlike heaters on some other cars in the new-size field, it does not burn gasoline or recirculate stale air.



**Full Tone Manual Radio** is transistor powered; brings in distant stations with ease. Excellent tone quality. This is a fine radio in every way, and its moderate price includes the antenna.

## Genuine Falcon Options and Accessories

To add still more flair to your Falcon, get the optional Deluxe Trim Package consisting of:

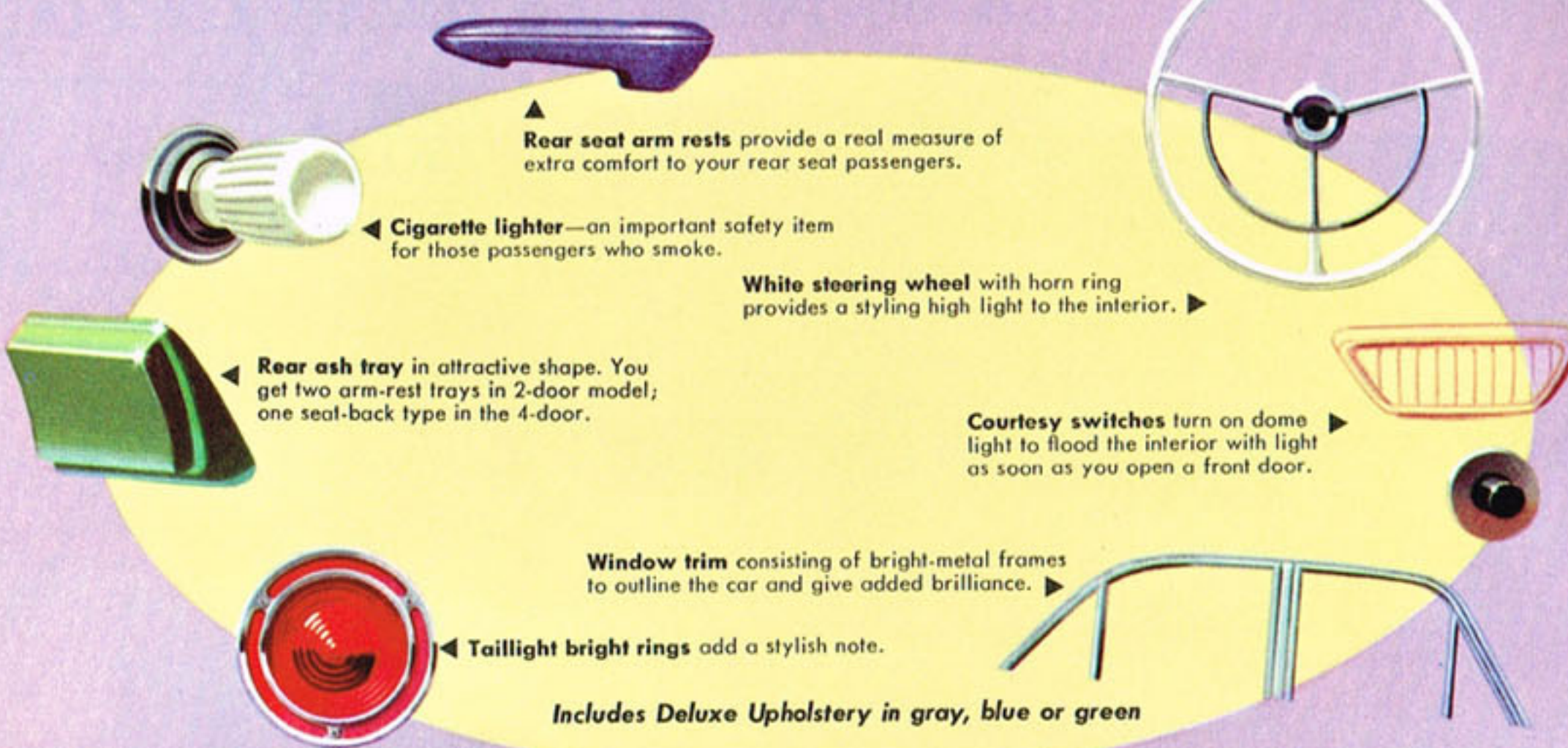

**Cigarette lighter**—an important safety item for those passengers who smoke.

**Rear seat arm rests** provide a real measure of extra comfort to your rear seat passengers.

**White steering wheel** with horn ring provides a styling high light to the interior.



**Rear ash tray** in attractive shape. You get two arm-rest trays in 2-door model; one seat-back type in the 4-door.

**Courtesy switches** turn on dome light to flood the interior with light as soon as you open a front door.

**Window trim** consisting of bright-metal frames to outline the car and give added brilliance.



**Taillight bright rings** add a stylish note.

Includes **Deluxe Upholstery** in gray, blue or green

Plus

FULL WHEEL COVERS \* TINTED WINDSHIELD  
66-PLATE, 55 AMP-HR BATTERY \* WINDSHIELD WASHER-WIPER \* FENDER ORNAMENT  
MIRROR, INTERIOR, NON-GLARE \* MIRROR, BODY MOUNT \* SEAT COVERS  
WHEEL RINGS \* LITTER CONTAINER \* WHITEWALL TIRES

## Completely new **6**-cylinder engine

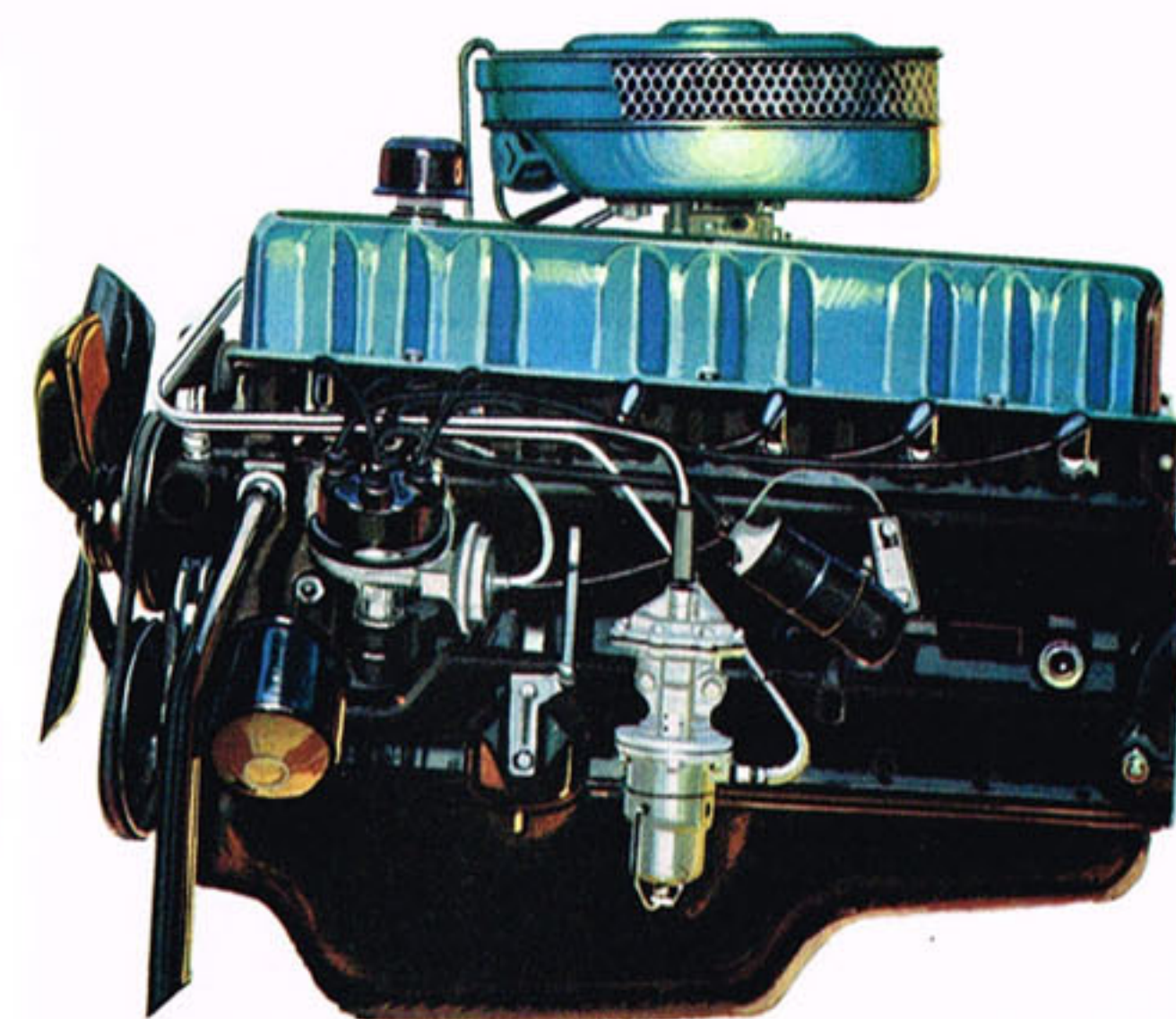

and you can have an **automatic transmission** in this New-Size **FORD**

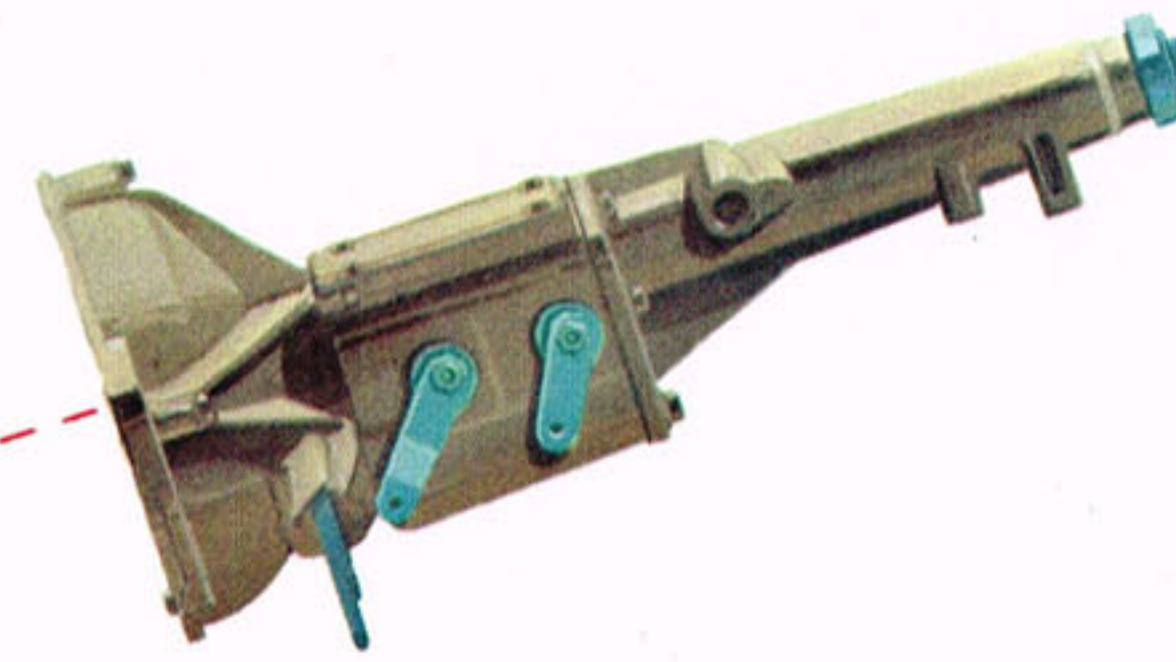

Designed specifically for the Falcon, there's nothing newer in engines than the in-line, front-mounted Falcon Six. Of *proven*, conventional design, this 90-hp power plant is built to pass and climb and keep you going for mile-after-mile!

Certainly you can have an *automatic drive* in your Falcon—and at surprisingly low cost, too. This new 2-speed Fordomatic (below) was designed expressly for the Falcon. If you prefer conventional shifting, choose the durable 3-speed manual transmission (shown above).

## Up to **30** miles per gallon...in **typical average driving**

The Falcon was designed as a thrifty car to operate—and it is! While many factors influence gasoline mileage, 30 miles per gallon is not unusual in a Falcon. Everything about Falcon helps it give excel-

lent gas mileage: it's light in weight, simply designed, and its engine has been tailored specifically for this car. Experience Run drivers *demonstrated* the Falcon's economy in every kind of driving!

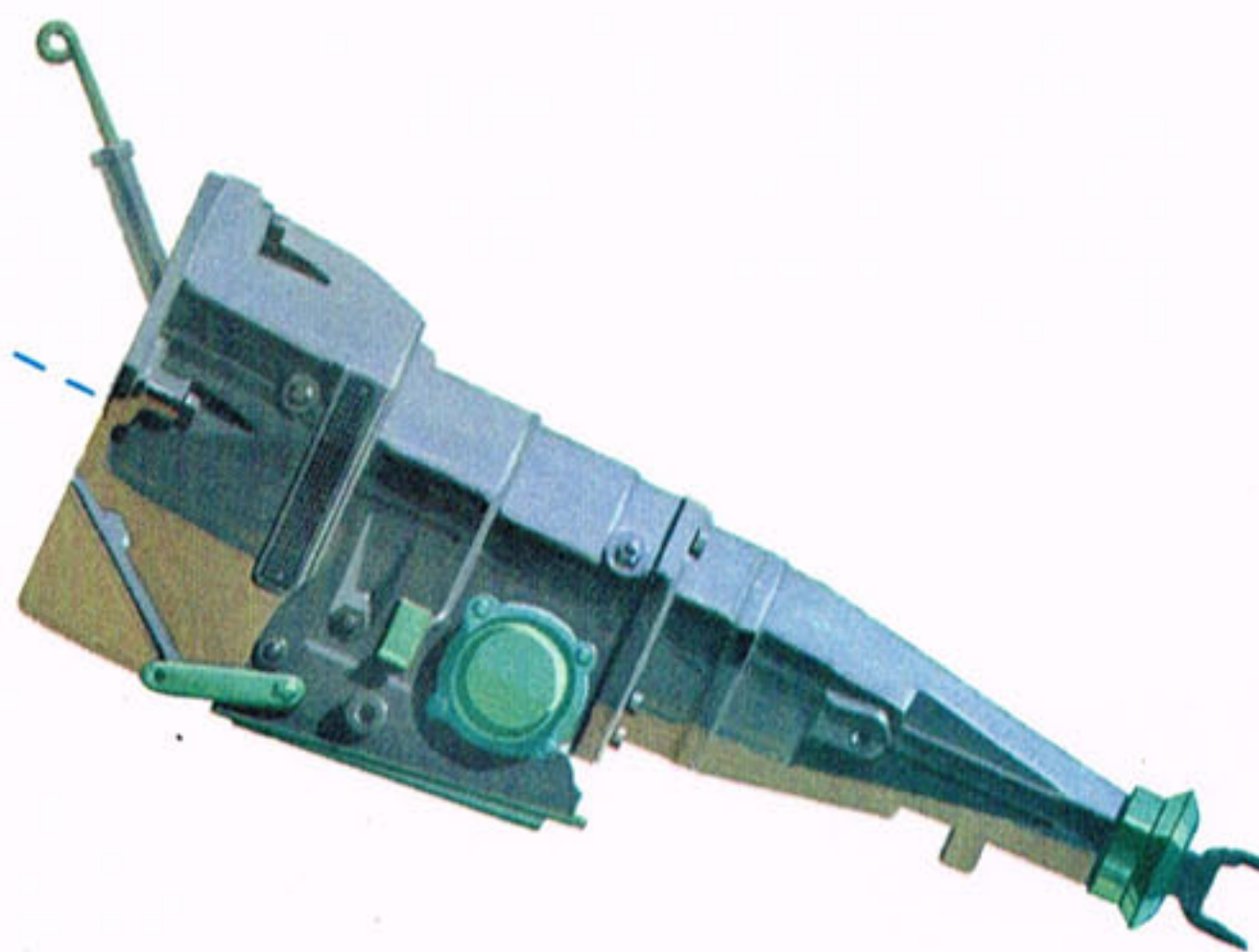

Ford Falcon

# SPECIFICATIONS

The new Ford Quality Audit system, a Ford first, results in products of highest quality. Quality Audit teams select samples from each shift at every assembly plant for an exhaustive search for any deviations from strict quality standards. This enables assembly operations to check and adhere to quality control at all times.

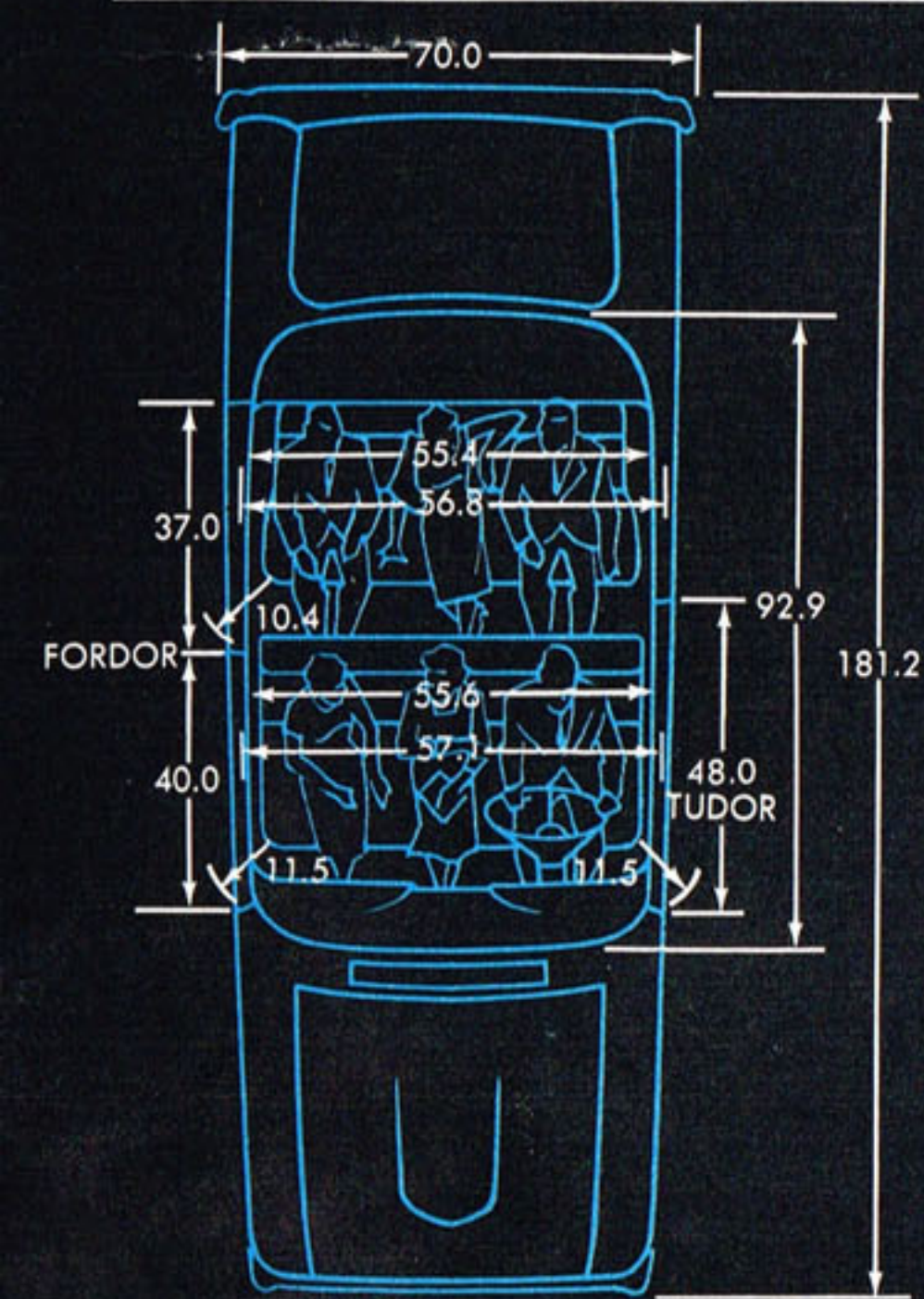
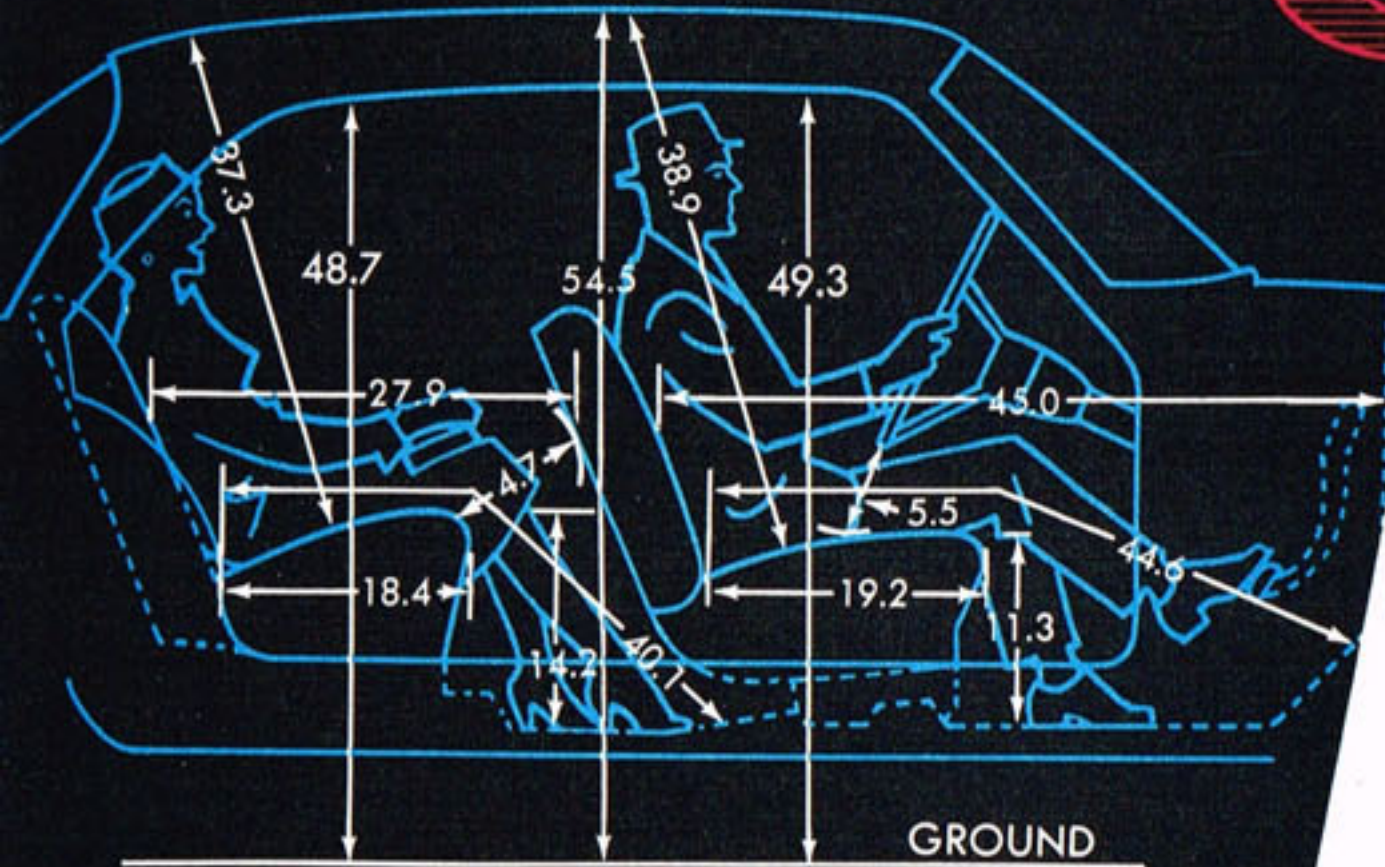

**Falcon Design:** All-new, welded, integral body and frame, with zinc-coated rocker panels and main underbody members, for durability and quietness with high strength-weight ratio. Completely sealed and insulated. Rear-hinged hood with outside safety-type latch. Chromed one-piece front and rear bumpers. Corrosion-resistant aluminum grille. Bright-metal windshield, rear window and drip moldings. Cowl-top ventilation system. Clear-vision safety glass throughout. Wide Angle windshield with forward-slanting pillars. Large, wide-opening doors. Lifeguard Double-Grip door locks. Posture Control front seat, adjustable to 9 positions. Rear-mounted 14-gal. gas tank with Center-Fill fueling.

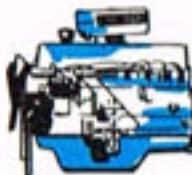

**Engine: 90-hp Falcon Six**—144-cu. in. displ.; 3.50" bore x 2.50" stroke; 8.7 to 1 comp. ratio; regular fuel, low-silhouette unit-design carburetor; manual choke; full-vacuum spark control; integral cylinder head and 6-port intake manifold; precision-molded crankshaft with four precision-type main bearings; rotor-type oil pump; oil capacity, with filter change, 4.5 qt.

**Features:** For economy and long life, the Falcon Six has Short Stroke, low-friction design; Wedge-Type combustion chambers; Free-Turning overhead intake and exhaust valves; 3-ring aluminum-alloy pistons with full-chromed top ring; Super-Filter air cleaner with reusable element; vacuum-booster type fuel pump for more constant windshield-wiper action; full-pressure lubrication system with Full-Flow disposable-type oil filter; pressurized cooling system with 180° Positive-Action thermostat; 12-volt electrical system; weatherproof ignition; 18-mm. Turbo-Action spark plugs; 54-plate, 40 amp-hr battery, positive engagement starter; 3-point rubber-insulated engine mounting; aluminum muffler. Engine is electronically balanced while operating under its own power for optimum smoothness.



**Clutch and Manual Transmission:** Single cushion disc, dry-plate clutch for smooth engagement; aluminum housing; permanently lubricated ball-bearing type throw-out bearing; suspended clutch pedal for easy action and no draft hole in toeboard. Face diameter is 8½ in. Total frictional area is 67.66 sq. in. 3-Speed Transmission has shot-peened fine-pitch helical gears for high strength and quietness with forged bronze synchronizers for smooth operation. Anti-friction bearings throughout. Standard "H" shift pattern with lever on steering column. Ratios (to 1): 1st 3.29, 2nd 1.75, direct 1.00, reverse 4.46.



**Fordomatic Drive (optional):** Features simplified design with one clutch assembly, lightweight cast-aluminum construction, minimum servicing (each 24,000 miles). Torque converter in combination with compound planetary gear set. Two forward gear ratios, one reverse (to 1): low 1.75, direct 1.00, reverse 1.50; converter (stall) 2.4. In "D" range gives brisk, smooth starts in low. Effective engine braking in "L" position. Air cooled. Selector lever and quadrant on steering column, sequence P-R-N-D-L.



**Rear Axle:** Semi-floating type with offset hypoid gears. Overhung drive pinion. Induction-hardened forged shafts with permanently lubricated, double-sealed ball-type wheel bearings. Needle roller bearing universal joints. Axle ratios: 3.10 to 1 (standard)—3.56 to 1 (optional).

Comparative information in this catalog was obtained from authoritative sources, but is not guaranteed. The specifications contained herein were in effect at the time this catalog was approved for printing. Ford Division of Ford Motor Company reserves the right to discontinue models at any time, or change specifications or design without notice and without incurring obligation.



**Front Suspension:** Angle-Poised Ball-Joint type with coil springs pivot-mounted and rubber-insulated at top on upper arms for soft ride. Strut-stabilized lower arms. Built-in anti-dive control. Internally mounted hydraulic double-acting shock absorbers with rebound cut-off. Front end has link-type, rubber-bushed ride stabilizer to control roll on turns. Tapered roller wheel bearings.



**Rear Suspension:** Longitudinal, semi-elliptic leaf springs of asymmetrical design with rear axle located forward from center of springs for anti-squat control on take-off. Provides soft-action, variable-rate with rubber-bushed supports and compression-type shackles for soft, leveled ride. Full length liners between leaves—no lubrication required. Axle nose bumper. Diagonally mounted hydraulic double-acting shock absorbers.



**Steering:** Magic-Circle low-friction recirculating-ball type steering gear provides easy handling. Protective rear mounting. Anti-friction bearings throughout. Symmetrical linkage. Over-all steering ratio 27 to 1. Lifeguard 17", black, 3-spoke, deep-center steering wheel. Turning diameter 38 ft.



**Brakes:** Truck Size double-sealed, self-energizing hydraulic brakes have suspended pedal and dash-mounted master cylinder. Composite drums, 9-in. diameter front and rear, with riveted linings, for long life, cool operation and fade resistance. Lining area is 114.3 sq. in. Offset "T" handle parking brake at left of steering column applies rear brakes.



**Tires:** 6.00 x 13 4-ply, low-profile, black, tubeless with Tyrex cord on 4" safety-type rims. Pressed steel ventilated disc wheels. Spare wheel and tire in luggage compartment.

**Standard Equipment:** Gray vinyl and nylon cloth interior. Two sun visors. Two front arm rests. Two parallel-action windshield wipers of the dual-range type. Inside rear-view mirror. Instrument panel with speedometer, odometer, fuel gauge, temperature gauge, oil and generator warning lights, high-beam and turn-signal indicators in cluster; lighted control identifications, ash tray, glove box. Dome light operated by headlight switch. Sealed-beam headlights, parking lights, taillights with stoplights and turn signals, license plate light. Sof-Tred black rubber floor covering.

**Dimensions:** 109.5" wheelbase. Tread: front 55", rear 54.5". Curb weight (est.): 2366 lb. Tudor, 2395 lb. Fordor. For other dimensions, see illustrations at left.

**Prices:** Optional Equipment and Accessories, illustrated or referred to in this catalog are at extra cost. For the price of the Falcon with the equipment you desire, see your Ford Dealer.

Compliments of



your friendly FORD dealer