

# LINCOLN CAPRI

*for 1952*

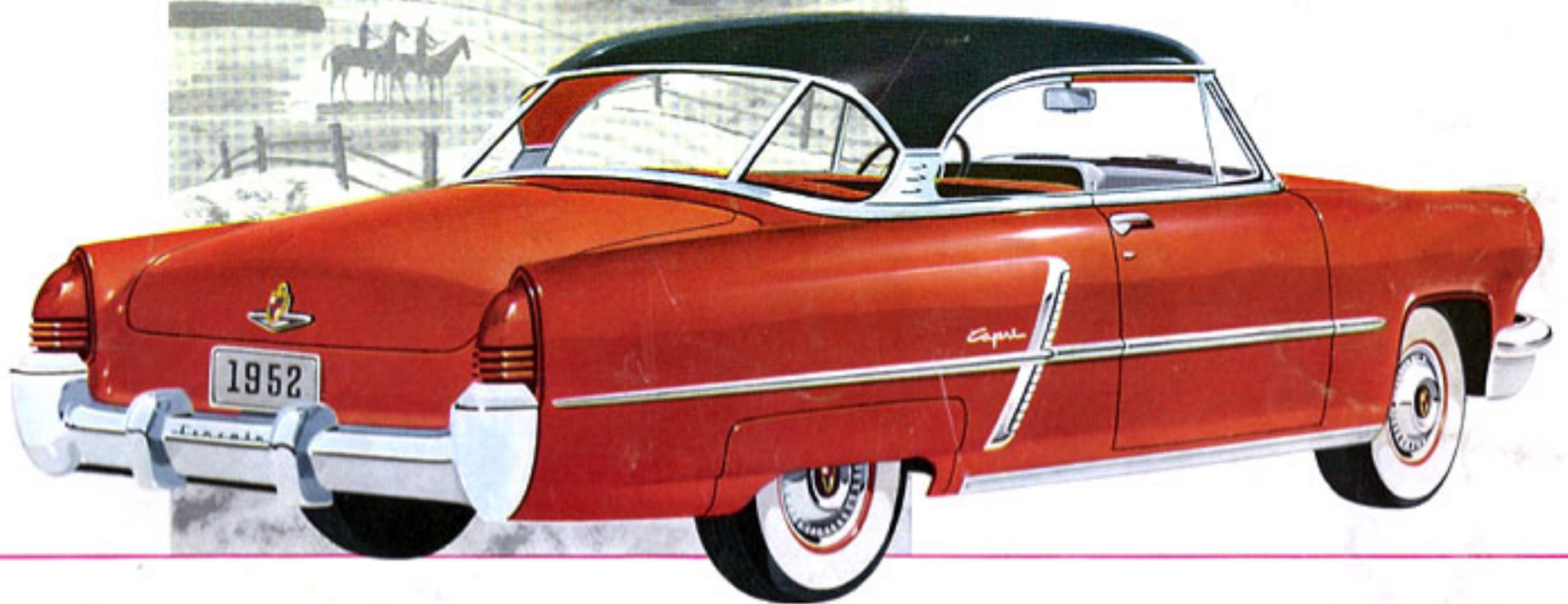

PLEASE ASK FOR  
S. CALVERT CONE

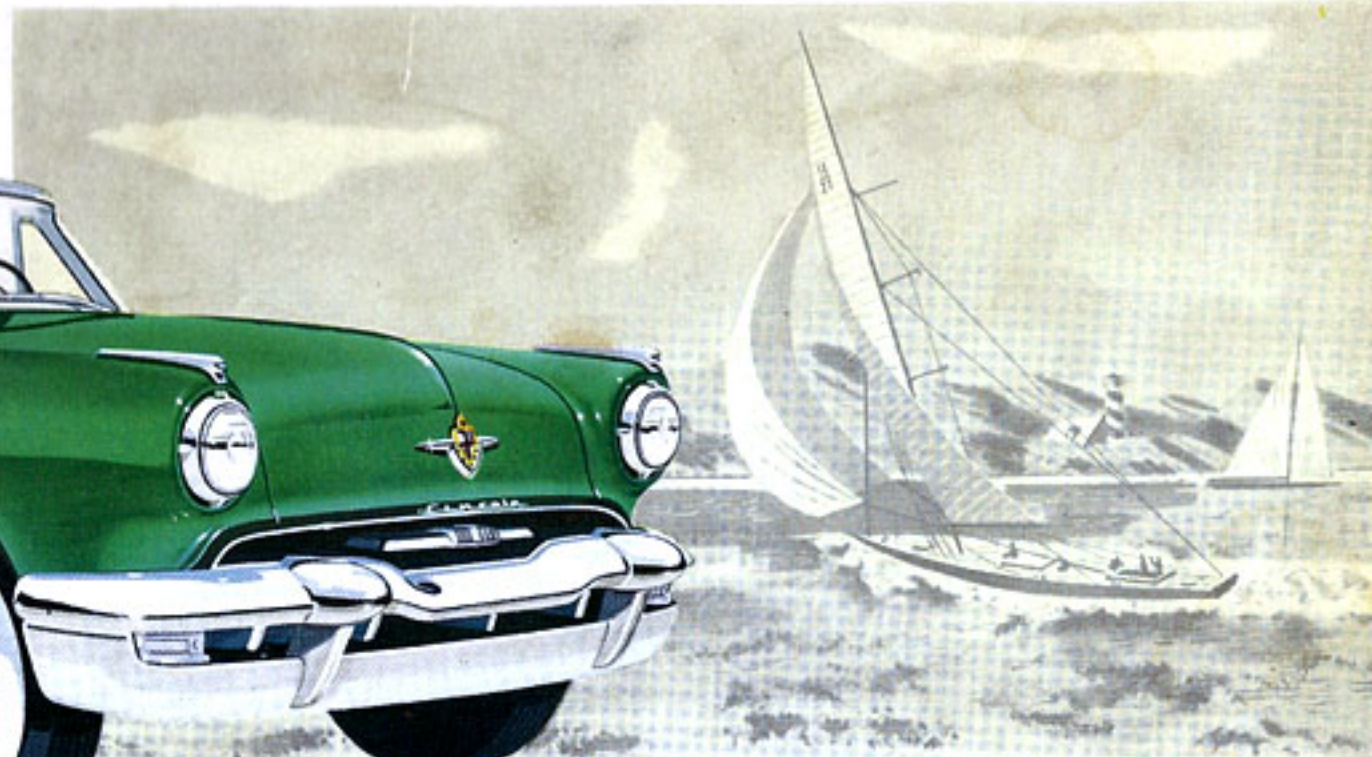
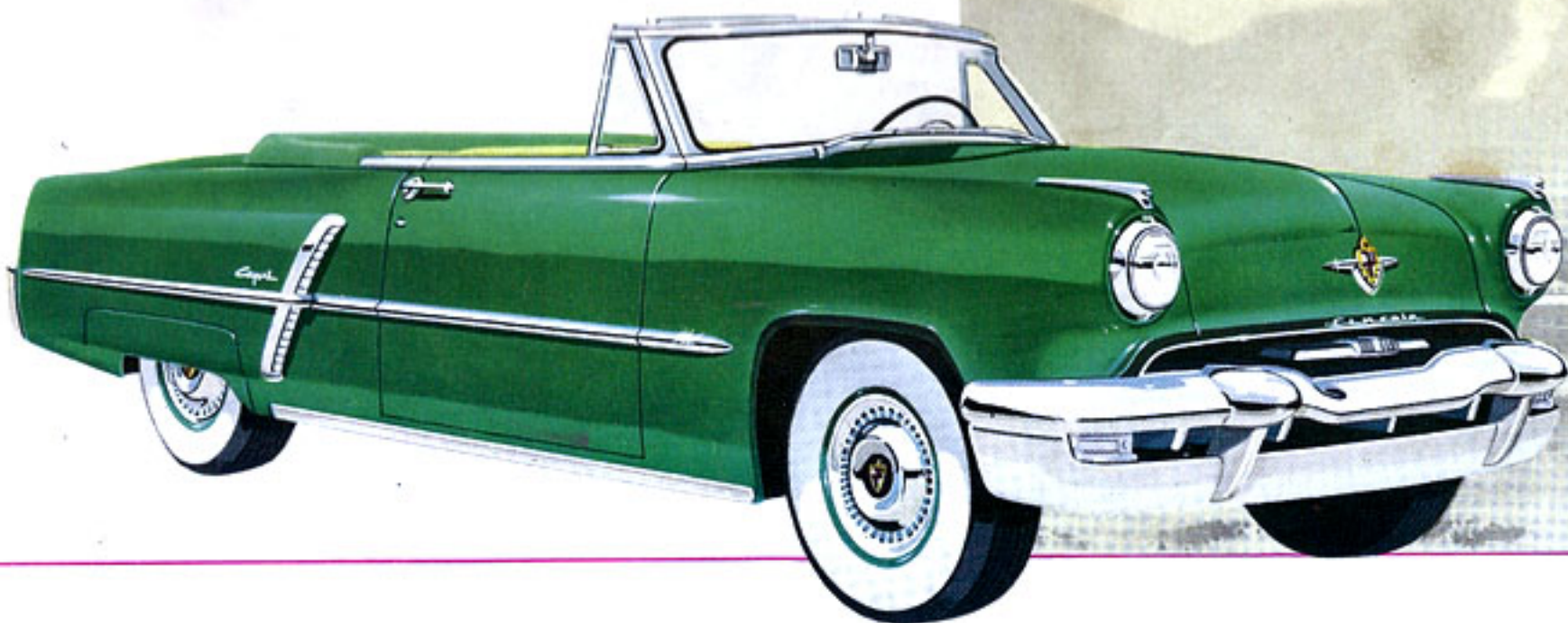

newly created for today's new living



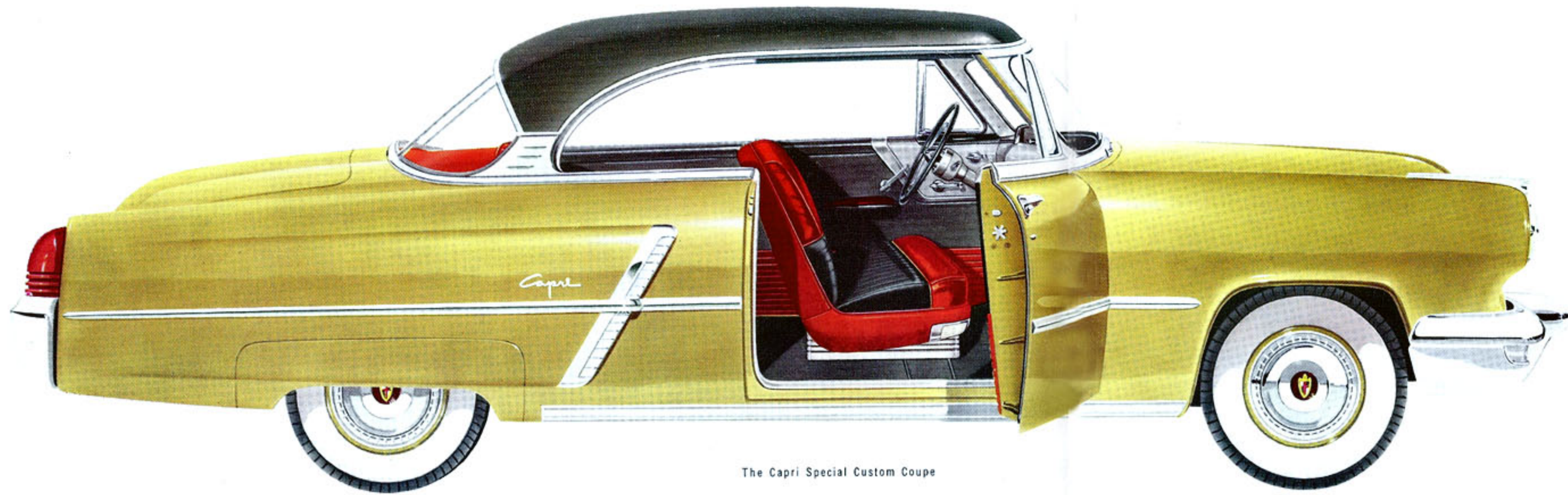

The Capri Special Custom Coupe

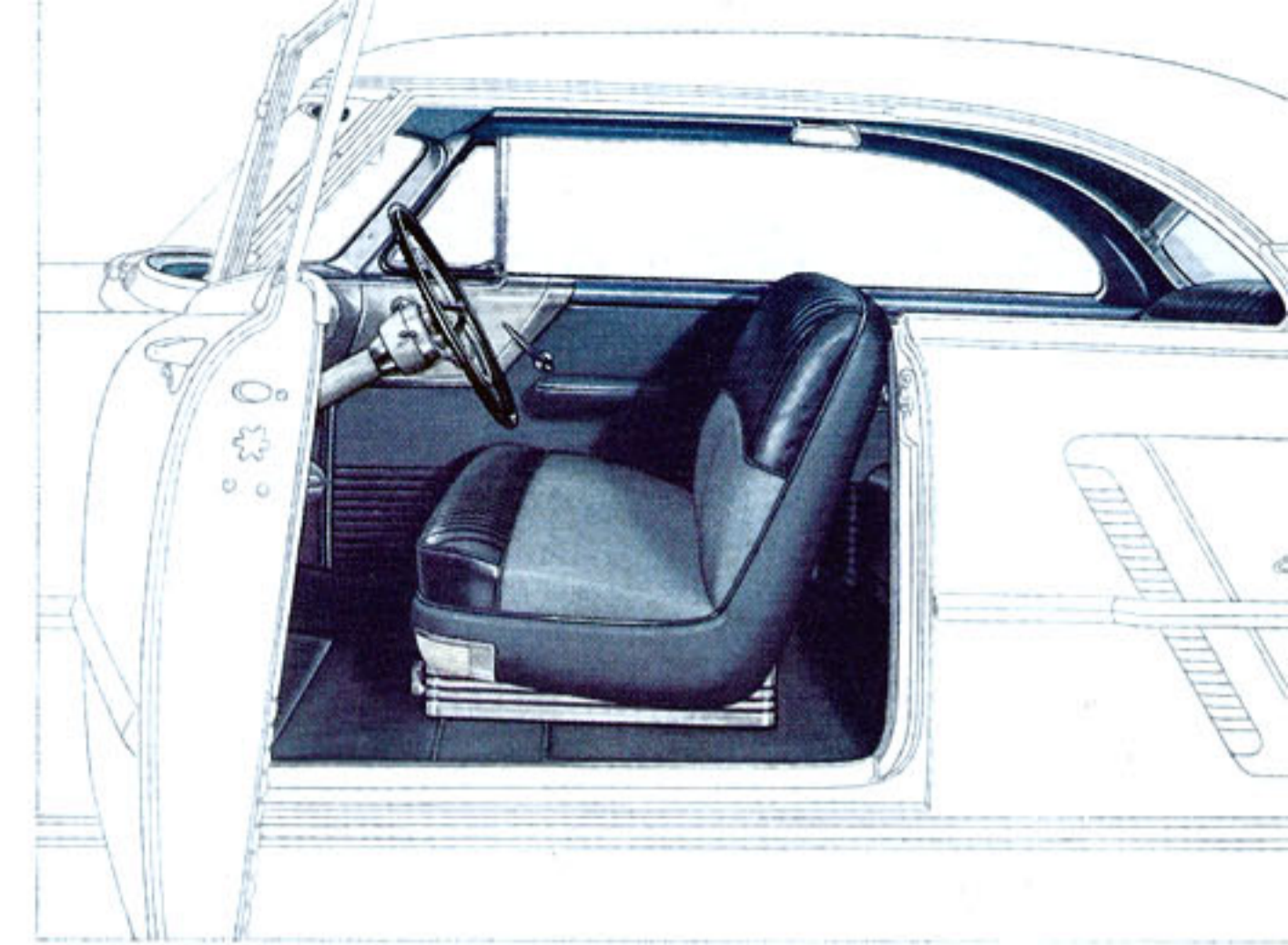

In every way the interior of the Capri Special Custom Coupe is a fresh, inspiring new motoring creation—combining the appeal of the convertible with the protective features of a superb sedan. Soft textured fabrics, with seat bolsters in soft leather of contrasting colors, provide a rich, yet smartly informal atmosphere. Automatically operated windows and front seat adjustment are optional equipment on all 1952 Lincoln models at extra cost.

The Capri Special Custom Convertible

The Capri Special Custom Convertible, as befits a car so suited to the out-of-doors spirit in living, is available in a wide range of harmonizing all-leather interiors—featuring pleated bolsters and forward seat edges. Similar interiors are available in the convertible-inspired, steel-topped Capri Special Custom Coupe, shown above, as optional equipment at extra cost.



## LUXURY — WITH A MODERN OUTLOOK

Contemporary as the indoor-outdoor living that gives so much extra zest to life today, is the new Lincoln Capri series—a Special Custom Coupe, Special Custom Four-door Sedan, and Special Custom Convertible.

In the superb new Capri Special Custom Coupe—equipped with a solid steel top—eyes will admire the debonair grace of its convertible styling.

In the Capri Special Custom Convertible, you will find an unusually satisfying treatment of long, low lines combined with a luxurious passenger compartment—including an electrically operated top. As on all 1952 Lincoln models, automatic window and seat adjustment controls are optional equipment, singly or in combination, available at extra cost.

Lincoln stylists used engineering sense in creating a modern steering wheel and instrument panel design to achieve a dual function. Not only are the lines, placement, and coloring of these vital elements harmoniously combined, they're functionally planned for most convenient use, too!

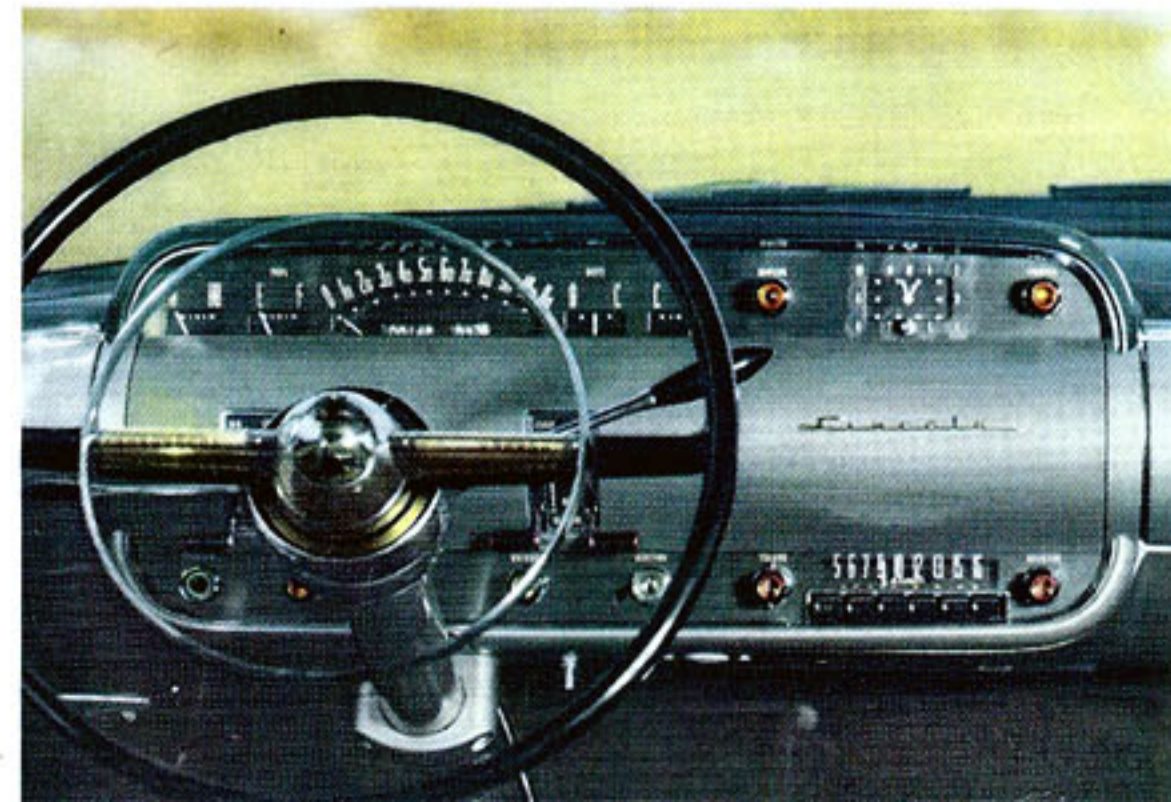

The steel-roofed Capri Special Custom Coupe offers the distinction of wide, deep windows which may be lowered completely with no center pillar to obstruct the view from windshield clear back to the curving rear roof line. And the Capri Special Custom Four-door Sedan brings the restful lines of both coupe and convertible to this popular family model.

In all three models, you may select from a variety of interior trims—ranging from a combination of choice fabrics with soft leathers in the Capri Special Custom Coupe to a completely pleated, all-leather interior in harmonizing contrasting tones in the striking Capri Special Custom Convertible.



The Capri Special Custom Four-door Sedan



# HIGHLIGHTS

of the

# Lincoln Capri

Most responsive fine car you've ever handled—that's Lincoln for 1952! Most responsive on the road because of Lincoln's new 160-hp overhead valve, V-eight engine. You'll get the full thrill of a new kind of performance the first time you press the accelerator . . . *with more power than you may ever need.*

Most eye-compelling styling on the road—inside and out. You'll delight at the custom luxury of new salon-spaced interiors. And you'll feel the thrill of owning a style-right car every time you drive. For this new air-stream styling has that low, dynamic appeal that turns all eyes . . .

Most easy-to-handle big cars you've ever driven, 1952 Lincolns feature a host of steering and handling features. New Ball-Joint front suspension, used for the first time on an American production car, gives greater handling ease; safer, more stable steering. And Lincoln's big-car compactness makes for easy parking. Superb on-the-road-poise makes Lincoln a restful car to drive.

New chassis, new steering, and new coordinated springing all combine to give a down-to-earth, road-hugging feel. At any speed, you'll find a new note in road-handling stability—cushioned springing, controlled riding action. You're master of the car on any road surface!

New standard for safety results from new panorama window visibility—front, sides, and rear . . . from new scientifically determined instrument and control arrangement—housed in a smart new "flight deck" panel frame. And in Lincoln for 1952 you get larger 4-wheel hydraulic brakes, controlled by an aircraft-type pendant pedal—for more responsive action and greater front compartment foot room! Brake cylinder moved to cleaner, more serviceable position on dash panel wall.

*All Lincoln cars available with automatic electric window lifts and automatic electric front seat adjustment at extra cost. White side-wall tires, when available, also supplied at extra cost.*

LINCOLN DIVISION OF THE FORD MOTOR COMPANY, DETROIT, MICHIGAN, WHOSE POLICY IS ONE OF CONTINUOUS IMPROVEMENT, RESERVES THE RIGHT TO DISCONTINUE OR CHANGE AT ANY TIME, SPECIFICATIONS, DESIGN, OR PRICES WITHOUT NOTICE AND WITHOUT INCURRING ANY OBLIGATION.

## Yours in a range of smart colors and fabulous fabric combinations

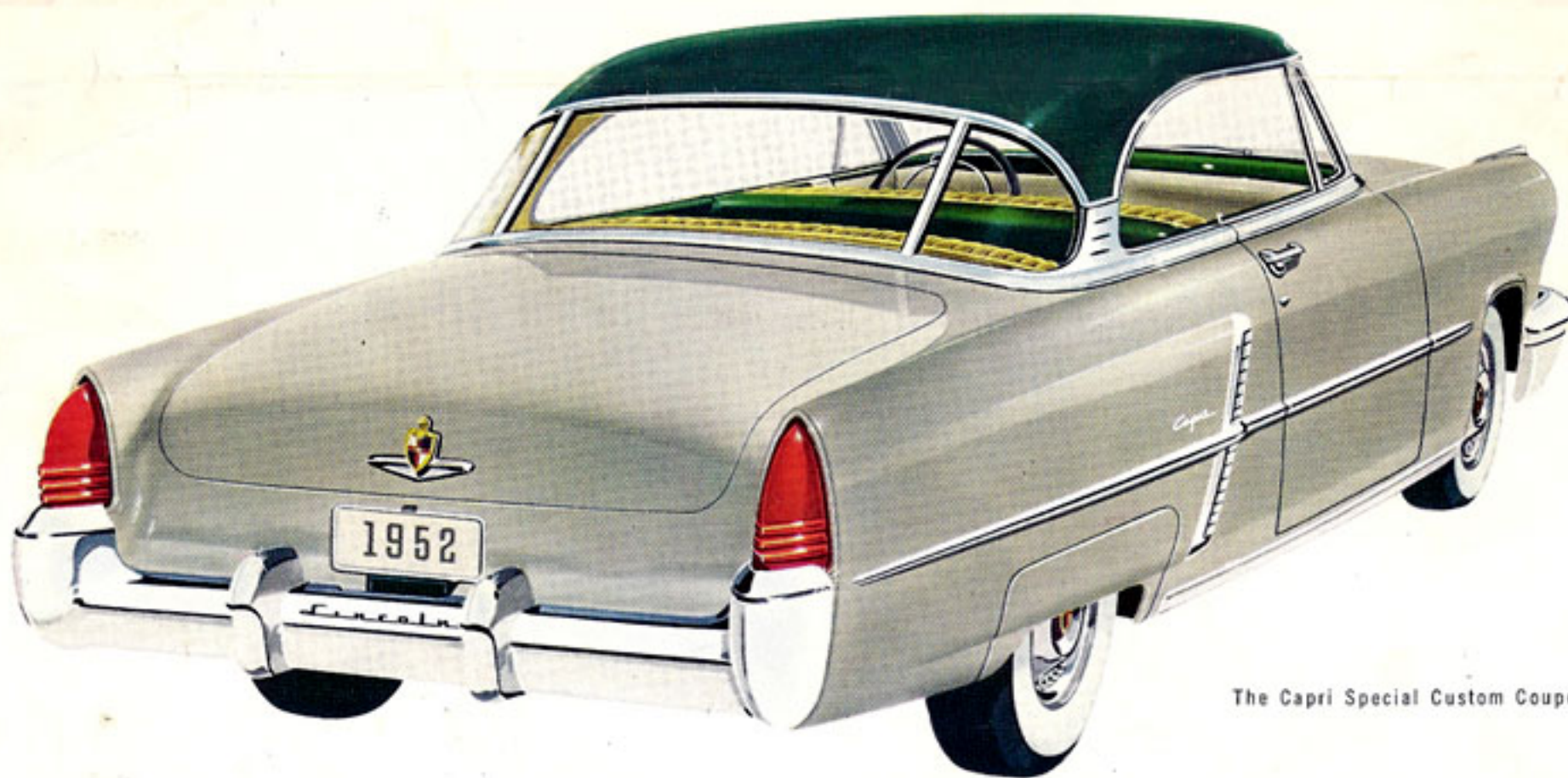

The Capri Special Custom Coupe

Capri Models have been especially styled to make the most of a new wider range of unique new body colors. Top, window, and bright trim areas have been "decorator-balanced" to give these new colors a more dynamic role in over-all smartness and eye-winning appeal.

Because the Lincoln Capri series was designed with color in mind, you can select from a wide range of fresh and different inside-and-out two-tone combinations—more individually appealing and distinctive, and superbly successful, than you've ever enjoyed before!



THE NEW

PLEASE ASK FOR  
S. CALVERT COME

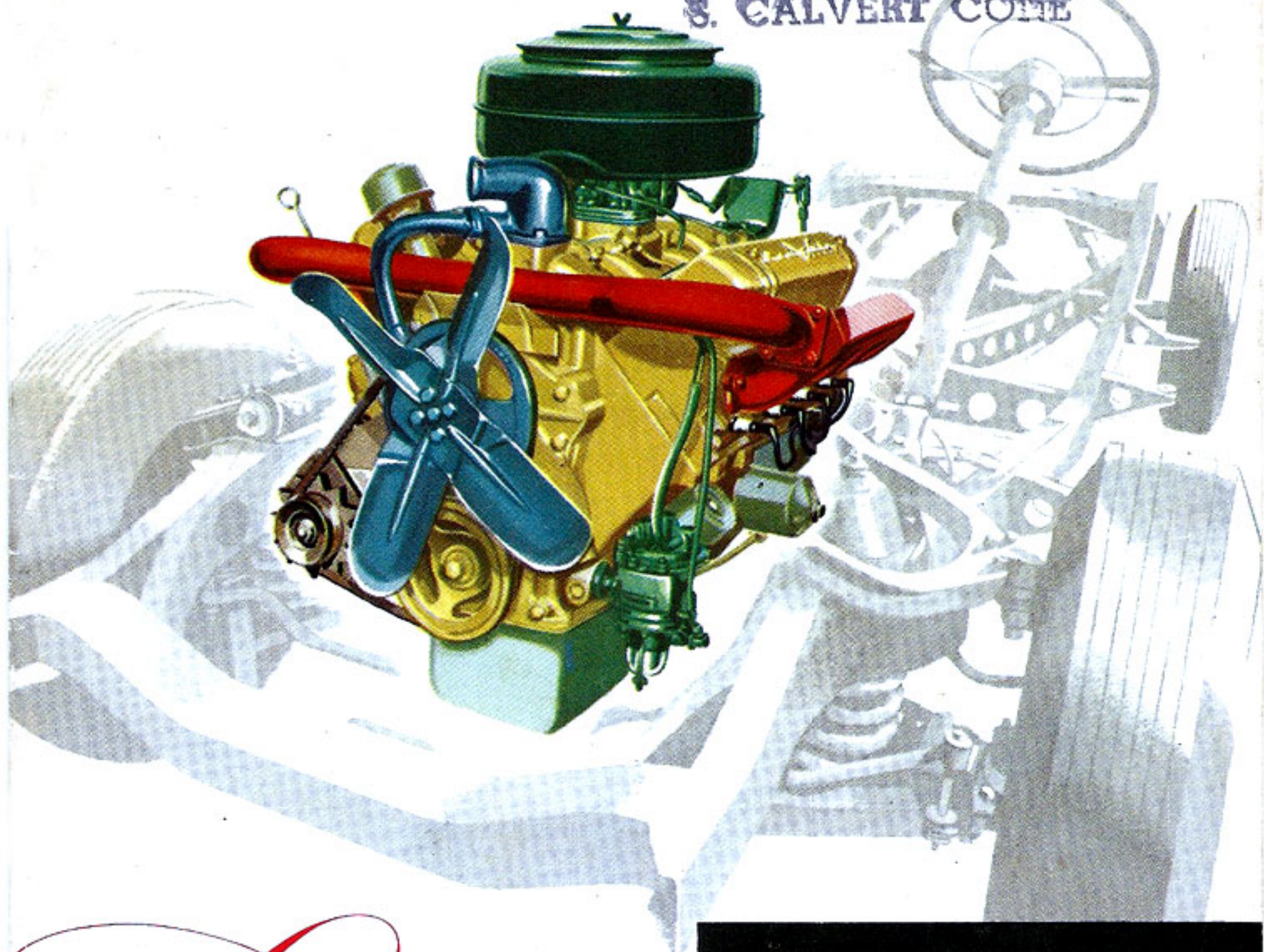

*Lincoln*

**V-EIGHT**

**HIGH-COMPRESSION**

**160-hp ENGINE**



# PRECISION ENGINEERED FOR PRECISION ACTION

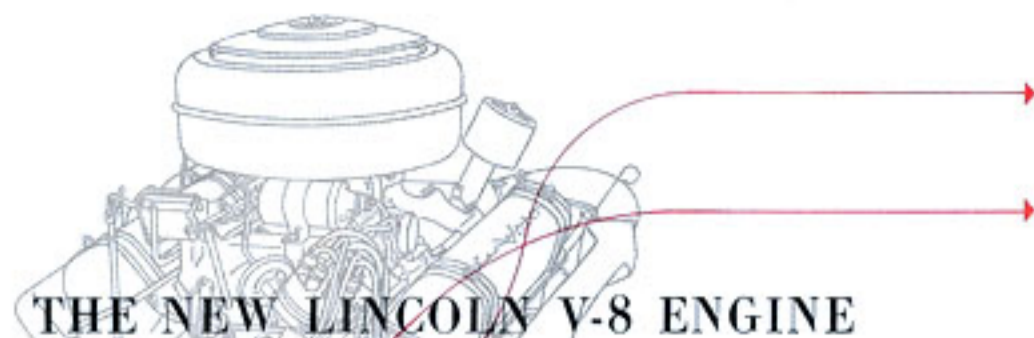

THE NEW LINCOLN V-8 ENGINE

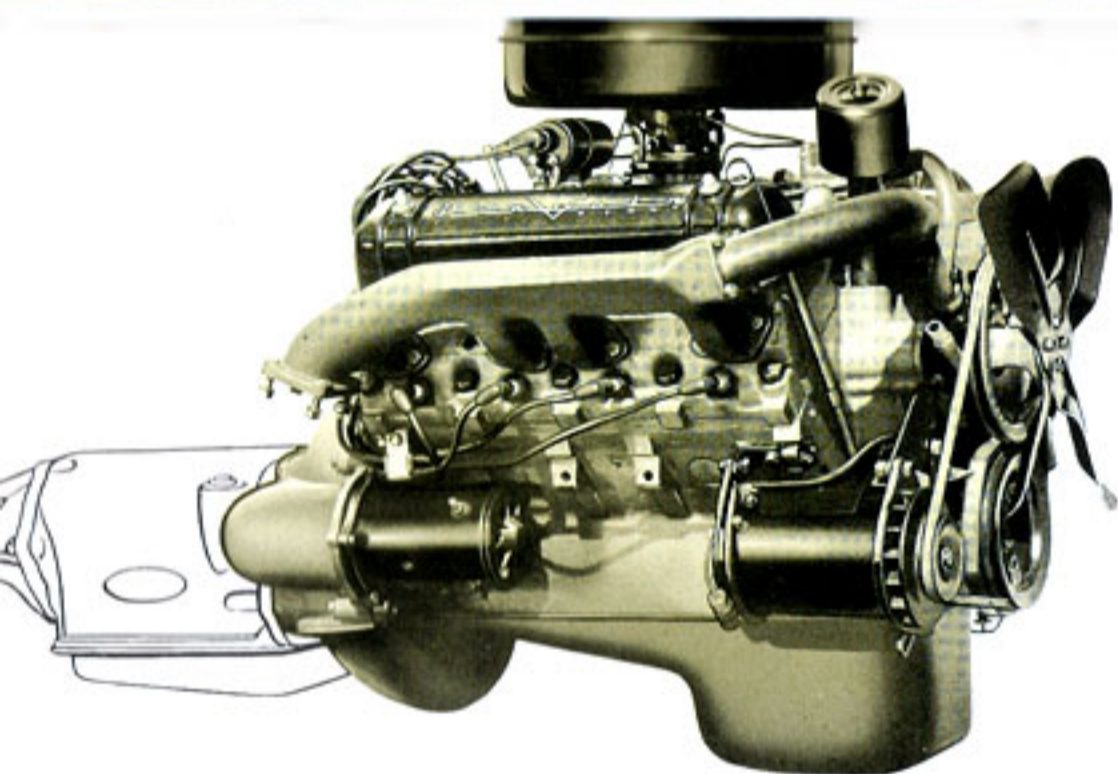
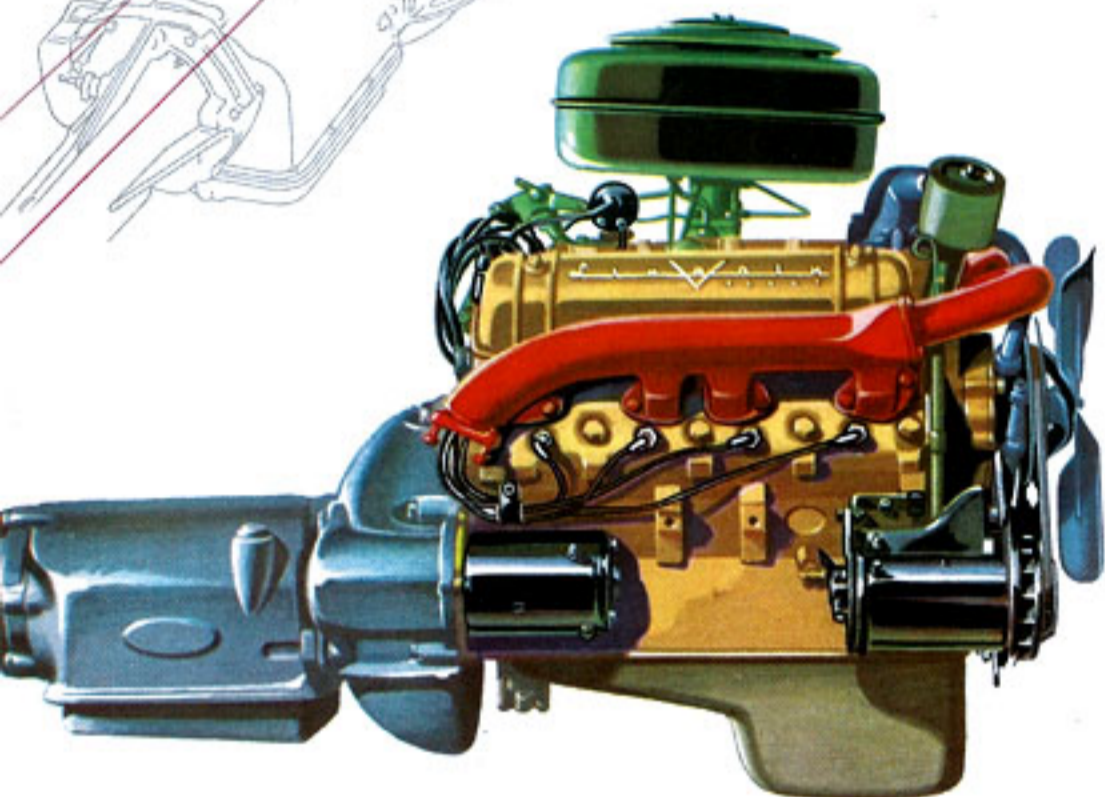

## CULMINATION OF 30

The 30-year history of the Lincoln Division of Ford Motor Company is a record of continuous progress and advancement in the development of newer and better V-type engines. During this period, Lincoln has introduced to the motoring public scores of engineering improvements in power plant design—produced literally hundreds of thousands of V-type engines—and has gained priceless experience in the design and manufacture of this kind of engine. *In its entire history, Lincoln has never built other than a V-type power plant.*

This year, with the introduction of a new overhead valve V-8, Lincoln reaches new heights of leadership in V-type engine design. The culmination of 30 years of progress in V-type engines, this remarkable, new Lincoln engine represents the newest, latest, and most advanced concepts of modern, high-compression, V-type power plant engineering. Now, these have been brought to their highest peak of development by the world's foremost producer and designer of V-type engines—thus giving American motorists new and higher standards of driving smoothness, performance, economy, and durability.

For 1952, Lincoln proudly presents an entirely new, overhead valve V-8 engine of advanced design—with more power than you may ever need.

Precision engineered to the newest and latest concepts of high-compression design, this new Lincoln V-8 engine represents the premium product of the Ford Motor Company—producer of more V-type engines than all other manufacturers combined. It is assuredly a worthy successor to the previous Lincoln V-type engine, which has firmly established itself as one of the best performing power plants in the motoring world.

Many advanced engineering features make this new Lincoln engine the indisputable performance leader for 1952. Among these is a new "Hi-Swirl" combustion chamber which assures thorough mixing of the fuel-air mixture to give more complete, even burning. This permits an increase in the compression ratio for extra gains in smoothness and economy.

The crankshaft of the new Lincoln V-8 engine is of a new "Nodular"-type cast iron, an exclusive Ford process that assures high precision of manufacturing. The crankshaft has five main bearings which are supported by an extra-deep and heavily reinforced crankcase. This crankcase actually extends below the axis of the crankshaft—another exclusive Lincoln feature, and one which contributes materially to the high degree of smoothness and quietness of operation of this great new Lincoln engine.

Other outstanding features include the new, rotating-type overhead valves with integral guides; the new, dual-downdraft carburetor with integral-mounted air cleaner; the new "Free-Flow" manifold; the new "Micro-Screen" full-flow oil filter; and many others. All of these engineering advancements contribute to greatly improved mechanical and thermal efficiency for increased power output, better economy, and smoother, quieter operation.

The product of years of intensive research and testing, this new Lincoln V-8 engine will give precision operation that far exceeds even the most stringent motoring requirements. In effect, it establishes a new standard for automotive power plants throughout the world.

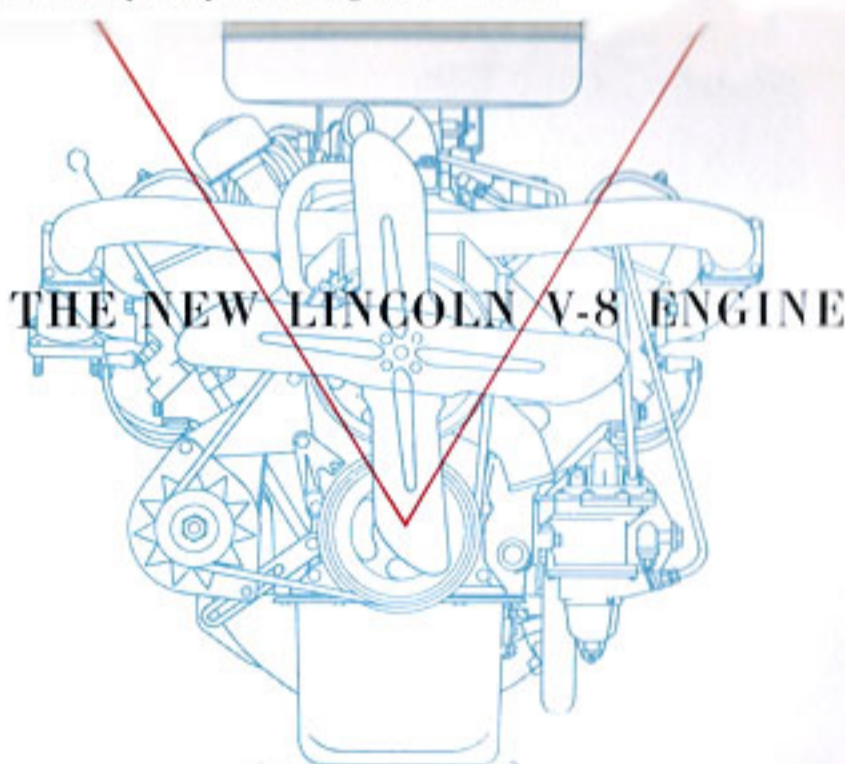

THE NEW LINCOLN V-8 ENGINE

## YEARS OF PROGRESS IN V-TYPE ENGINES

### LINCOLN ENGINE OFFERS MORE IN EVERY WAY

#### the "right" power

The Lincoln engine's 160-hp gives the ideal power-weight ratio for Lincoln cars—the perfect combination for best all-round performance and economy.

#### precision performance

This newer, more efficient, higher compression-ratio V-8 design gives smoother, quicker acceleration—more responsive performance—and better economy.

#### smoother, quieter operation

Every component of the Lincoln V-8 engine—from the five-bearing, completely counterbalanced crankshaft to the silent overhead valves—is designed to give smoother, quieter operation.

#### better fuel economy

A higher compression ratio means greater operating efficiency. The new Lincoln V-8 engine with a compression ratio of 7.5 to 1 is able to squeeze more miles out of every drop of gasoline.

#### lower maintenance costs

Simpler in design, more compact in construction, the Lincoln engine requires less service attention, with resultant savings in maintenance costs.

#### longer life design

The new Lincoln V-8 engine's extra-deep, reinforced crankcase and sturdy "Nodular"-type cast iron crankshaft provide longer life and greater durability.



# AN ADVANCED V-8 DESIGN THAT'S BASICALLY BETTER

The new Lincoln V-8 engine is an entirely new, overhead valve V-type power plant of better basic design. Smaller in size and lighter in weight than previous V-type engines, it nevertheless develops higher horsepower, is more economical to operate, and is smoother and quieter in operation. Its advanced V-type design can take full advantage of higher octane fuels as they become available.



**"hi-swirl" combustion chamber**  
The exclusive Lincoln "Hi-Swirl" combustion chamber provides greater turbulence of the fuel-air mixture for more efficient burning. It also permits the use of a higher compression ratio—giving extra gains in smoothness and economy.

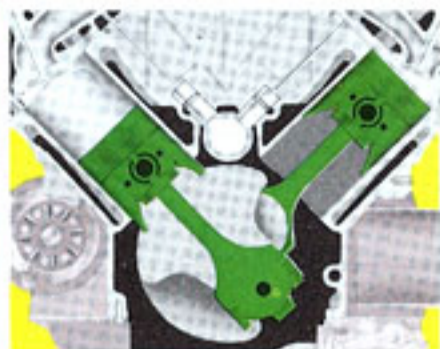

**shorter piston stroke**  
The short-stroke, large-bore design principle of the new Lincoln engine results in slower piston speed, which means less vibration and less friction. Also, since there is less cylinder wall area exposed, heat losses are appreciably reduced.

**efficient overhead valve design**  
Simple overhead valve arrangement contributes to smooth, reliable engine performance by assuring free, unrestricted passage of fuel-air mixture and exhaust gases. Hydraulic valve lifters assure quiet, efficient valve operation at all speeds.

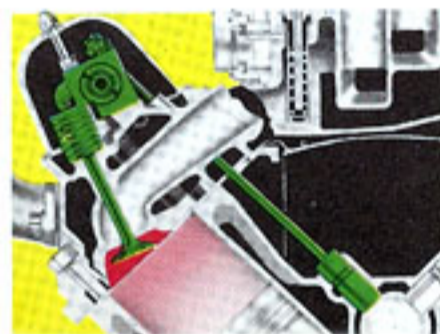

**"free-flow" manifolding**  
Highly efficient "Free-Flow" manifolding system of Lincoln engine has large-diameter, equal-length passages for uniform distribution of fuel-air mixture to cylinders, and direct-passage exhaust manifolding for quick, efficient removal of exhaust gases.

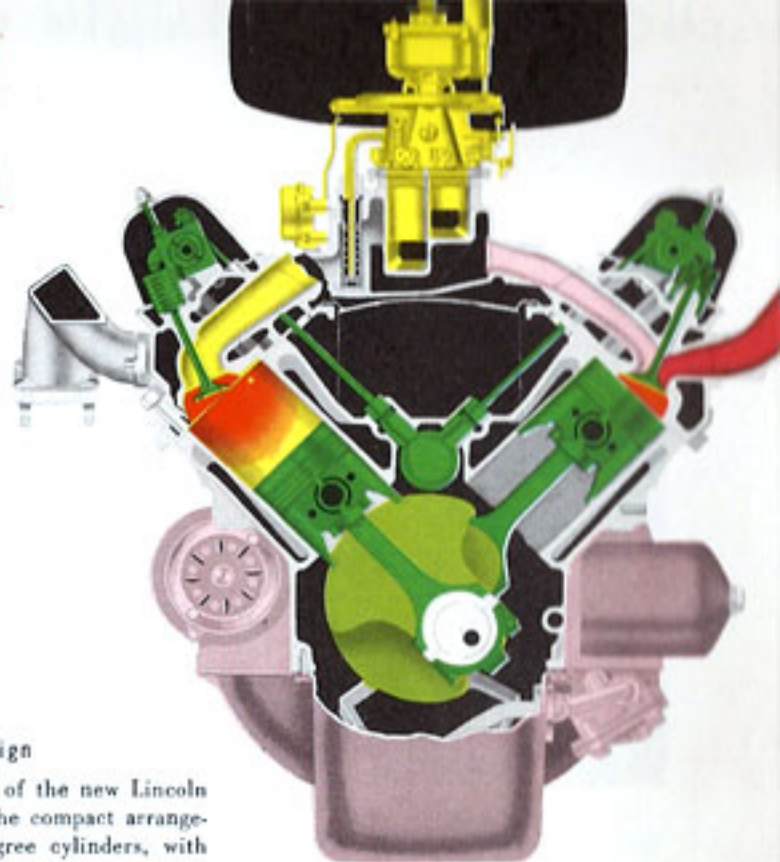

## more compact design

This sectional view of the new Lincoln V-8 engine shows the compact arrangement of the 90-degree cylinders, with short piston stroke, simple arrangement of overhead valves, compact combustion chamber, and extra-deep, reinforced crankcase. This design provides a shorter over-all length, which means more room inside the car for passengers, and a shorter hood for better visibility.

## FOUR BASIC REASONS WHY LINCOLN V-8 ENGINE IS BETTER

### better breathing

The Lincoln V-8 engine is better in breathing capacity because of its new dual-downdraft carburetor, "Free-Flow" manifolding, extra-large valve ports, and "Hi-Swirl" combustion chamber.

### better burning

"Hi-Swirl" combustion chamber assures thorough mixing of the fuel-air mixture, and more complete, even burning—which means that larger percentage of heat is converted into useful power.

### better cooling

Full-length water jackets encircle each cylinder to provide accurate temperature control. Direct-passage exhaust manifolding removes hot gases quickly. Less heat is thus lost to the cooling system.

### better mechanical efficiency

The new Lincoln V-8 engine has better mechanical efficiency because friction is less. This is due to shorter piston stroke, which reduces piston speed and, thus, sliding friction in the cylinder.

make the most of

LINCOLN'S BETTER BASIC DESIGN

In addition to its advanced, overhead valve, high-compression design, the new Lincoln V-8 engine offers many other remarkable engineering advancements. Some of those are pictured below. A more complete list, however, would also include such features as: an automatic by-pass thermostat, a new-

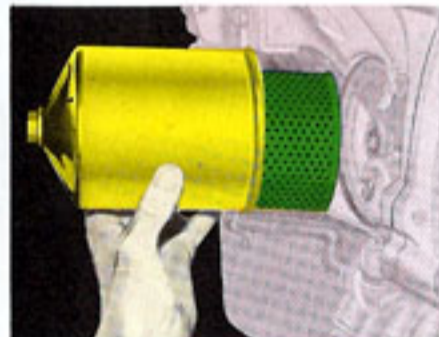

**"micro-screen" oil filter**  
New Lincoln "Micro-Screen" oil filter is of the full-flow type, with automatic by-pass valve. It filters all of the oil going into the engine, removing harmful abrasive material which might damage vital engine parts.



**positive crankcase ventilation**  
Highly efficient ventilation system takes in outside air through filter in filler pipe, and circulates it through both valve chamber and crankcase. Picks up harmful "blow-by" gases and exhausts them through road tube.

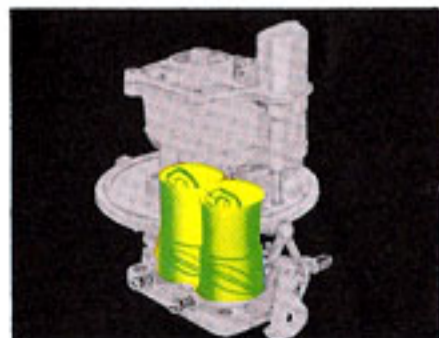

**dual-downdraft carburetor**  
Lincoln carburetor is of the dual-downdraft, concentric-bowl type which gives precise fuel metering under all driving conditions. The oil-bath air cleaner mounts directly over and around the carburetor.



**hydraulic valve lifters**  
Automatic adjustment of valve clearance is provided by hydraulic valve lifters. They maintain clearance throughout valve linkage at absolute zero—insuring quiet valve action and efficient engine operation.



**rotating-type valves with integral guides**  
Special spring retainers permit valves to rotate when in operation—giving smoother, quieter engine operation and longer valve life. Guides are cast integral with cylinder head. This keeps valves 100-degrees cooler.

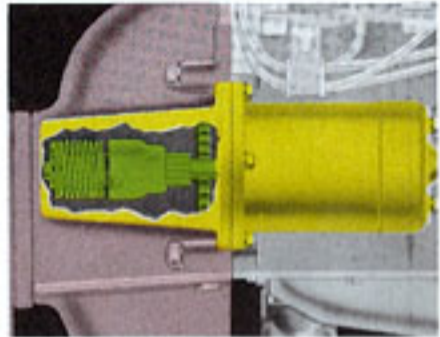

**ratchet-type starter**  
Unique ratchet device in starter keeps starter drive gear engaged until the engine speed reaches approximately 300 rpm—giving quicker, easier starting with less wear and tear on the starter motor.

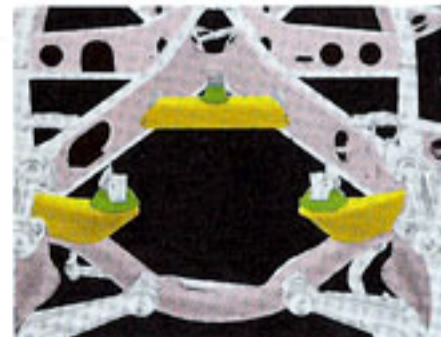

**"center-poise" engine mounts**  
Lincoln engine is carried in balance on three rubber-insulated supports—two in front at the center of gravity of the engine, and one at the rear. This mounting provides effective cushioning of engine vibration.

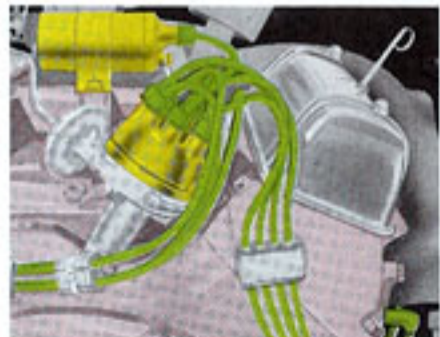

**weatherproofed ignition**  
All vital parts of the Lincoln engine's ignition system—spark plugs, high-tension wiring, connections to coil and distributor—are protected against moisture and wet weather by special neoprene coverings.

type automatic choke, pressure lubrication, chain-driven timing gear, high-lift camshaft, integral valve guides, chrome-plated top piston ring—all of which combine to make this new Lincoln power plant the smoothest, quietest, most economical, and best performing automobile engine in its field.



# facts and FIGURES

## OF THE NEW LINCOLN V-8 ENGINE

The 1952 Lincoln engine is an overhead valve, advanced-design, 90° V-8, developing 160-horsepower at 3900 rpm and 284 ft-lb torque at 1800 rpm. Bore, 3.8 in.; stroke 3.5 in. Displacement, 317.5 cu in. Compression ratio, 7.5 to 1. Counterbalanced crankshaft of Nodular-type cast iron with five selectively-fitted main bearings of replaceable, micro-babbitt precision type. Slipper-type aluminum-alloy pistons with steel-strut inserts for controlled expansion. Chain-driven camshaft. Two compression rings, and one oil ring. Top ring chrome-plated for long life. Rotating-type valves with integral guides and self-adjusting hydraulic valve lifters.

Pressure lubrication to valve-lifters and all main, connecting rod and camshaft bearings. Gear-type oil pump. "Micro-Screen" full-flow oil filter. Positive crankcase ventilation. Oil capacity, 5 quarts (refill).

Single, high-capacity water pump, permanently lubricated. Full-length water jacket cylinders for efficient cooling and better oil economy. Automatic by-pass thermostat for quick warm-up. Lo-speed, 4-bladed silent fan. Controlled-pressure radiator. Coolant capacity, 24.5 quarts.

Dual-downdraft, concentric-bowl carburetor of simplified design. Integral oil-bath air cleaner. Automatic idling control. Automatic choke with manifold-mounted heat control. "Free-Flow" manifolding.

High-capacity, lightweight 63-plate, 110-ampere-hour battery. High-capacity generator with automatic current and voltage control. Ratchet-type starter with 16.8 to 1 cranking ratio. High-speed, single breaker-arm distributor with full-pressure type automatic spark control.

*These specifications were in effect at the time this manual was approved for printing. Lincoln Division of Ford Motor Company, Detroit, Michigan, whose policy is one of continuous improvement, reserves the right, however, to discontinue or change at any time, specifications, design or prices without notice and without incurring any obligation.*

rating

MULLER & MULLER, INC.  
638 SUNRISE HIGHWAY  
ROCKVILLE CENTRE, NEW YORK  
TEL. R.V.C. 6-1515

lubrication

cooling

fuel system

electrical

LINCOLN DIVISION • FORD MOTOR COMPANY