

The Ford V-8 --- for 1950

**Deluxe and
Custom Deluxe**

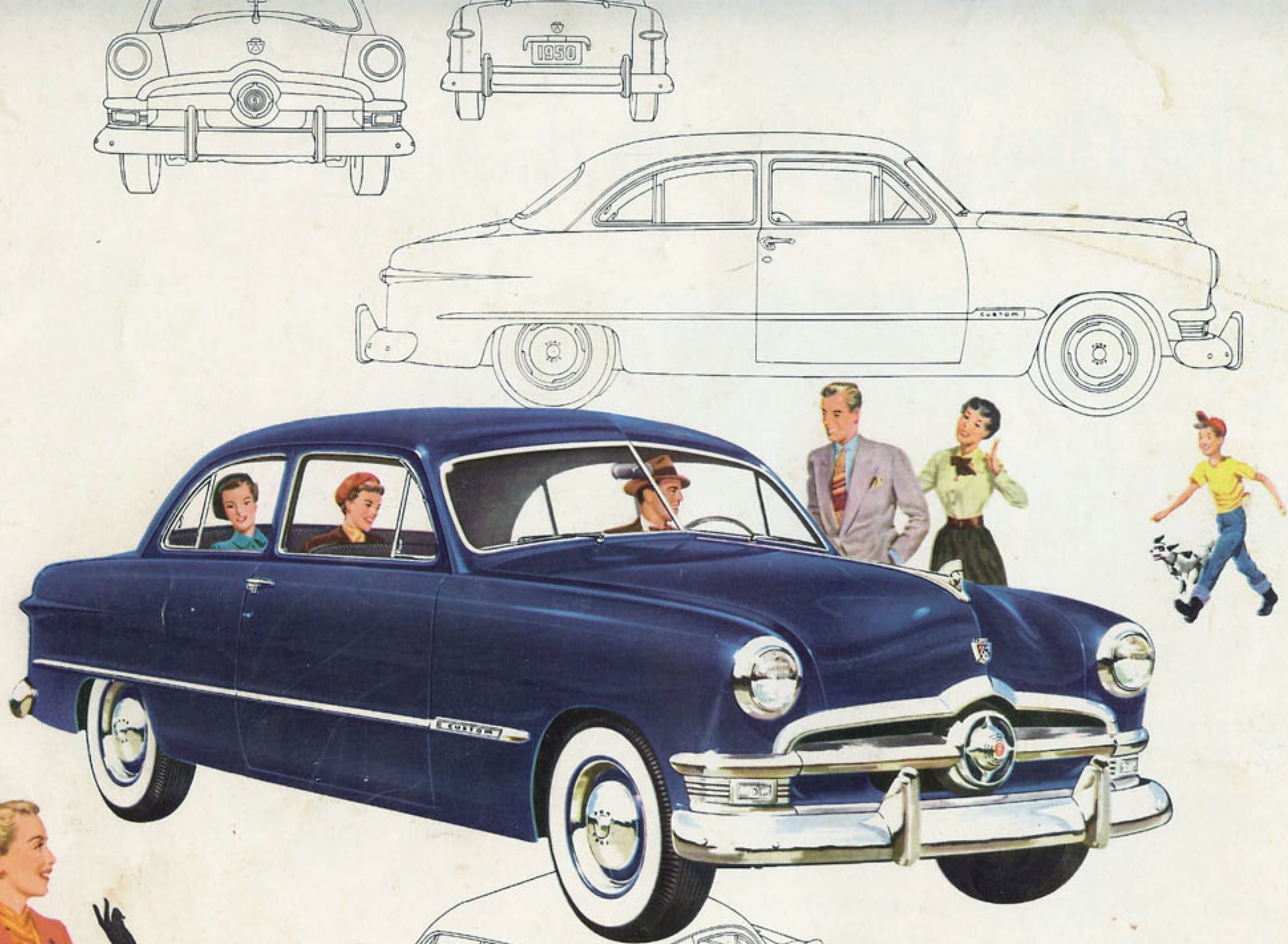

FORD CUSTOM DELUXE TUDOR SEDAN

White sidewall tires optional at extra cost





The One Fine Car in its Field

QUALITY is the word for the '50 Ford. With its new silent 100-h.p. V-8 engine, the new Ford is a triumph of advanced engineering. It offers the same type engine used in America's highest priced cars . . . yet it sells in the low-price field. Yes, Ford is the only car in its price class that gives you eight cylinder power . . . V-8 power . . . and you get it for less money than is charged for most makes of six-cylinder cars!

You get a new "Hushed" Ride—a "Mid Ship" Ride with doors, roof and body panels "sound-conditioned" against road noises. You travel between the wheels, cushioned by "Hydra-Coil" Front Springs and "Para-Flex" Rear Springs. And remember, Ford's unit-welded heavy steel "Lifeguard" Body is reinforced at 13 additional points. This means long years of *quiet* driving as well as *safe* driving.

It's the "Fashion Car" even more beautiful than ever! New baked-on enamel colors keep their freshness because they're "built to live outdoors." New upholstery materials bring you sparkling new color combinations! New colorful instrument panel groups all controls for easy access and readability. Even the door locks and push-button handles are new. A feather touch closes doors securely. But take the wheel of the '50 Ford today. When you "feel" the difference you'll be sure to agree, "It's the one *fine* car in the low-price field."

There's a *Ford* in your future...with a future built in!





The 1950 Ford Custom Deluxe Tudor Sedan

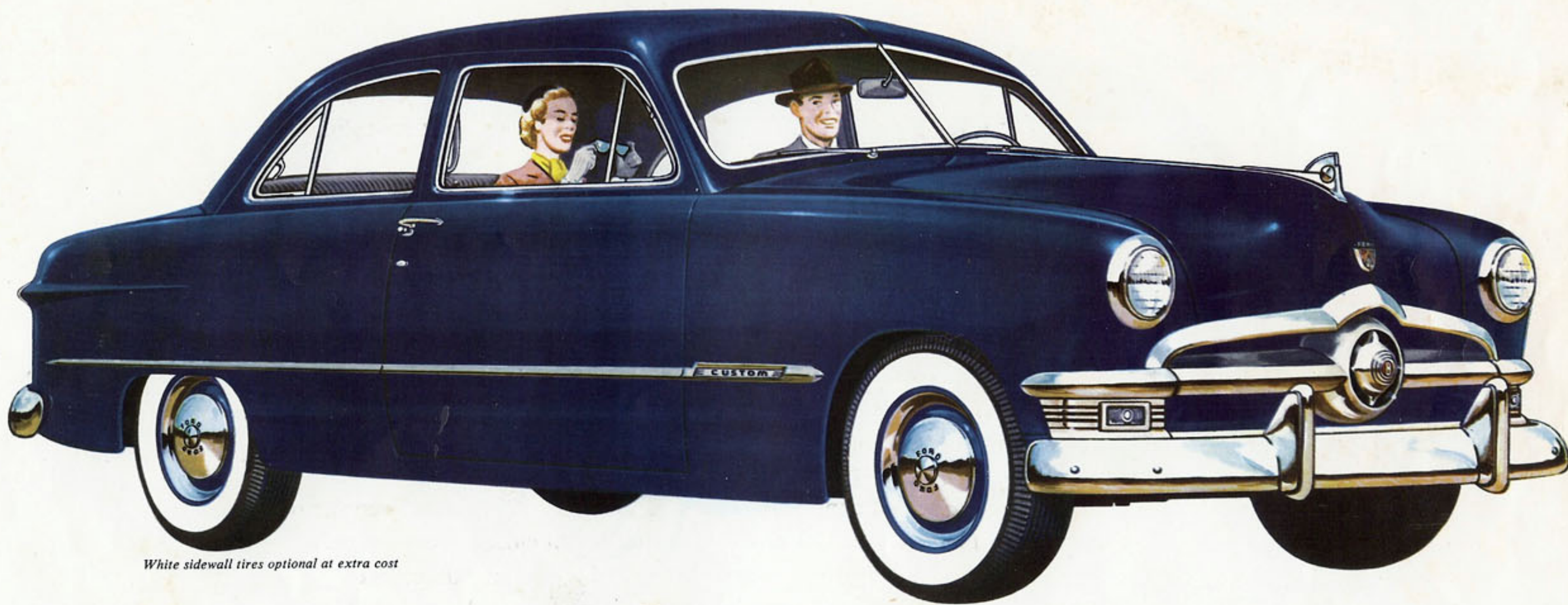

White sidewall tires optional at extra cost



There's room for the whole family, and then some, in this beautiful Tudor. For this model, like all the '50 Fords, brings you seats with the most hip and shoulder room in the low-price field—room for six big people. They're extra comfortable seats, too! With new non-sag front seat springs and foam rubber cushion to relax on, you'll drive hundreds of miles without fatigue.

The Tudor Sedan is also available in the Ford Deluxe series

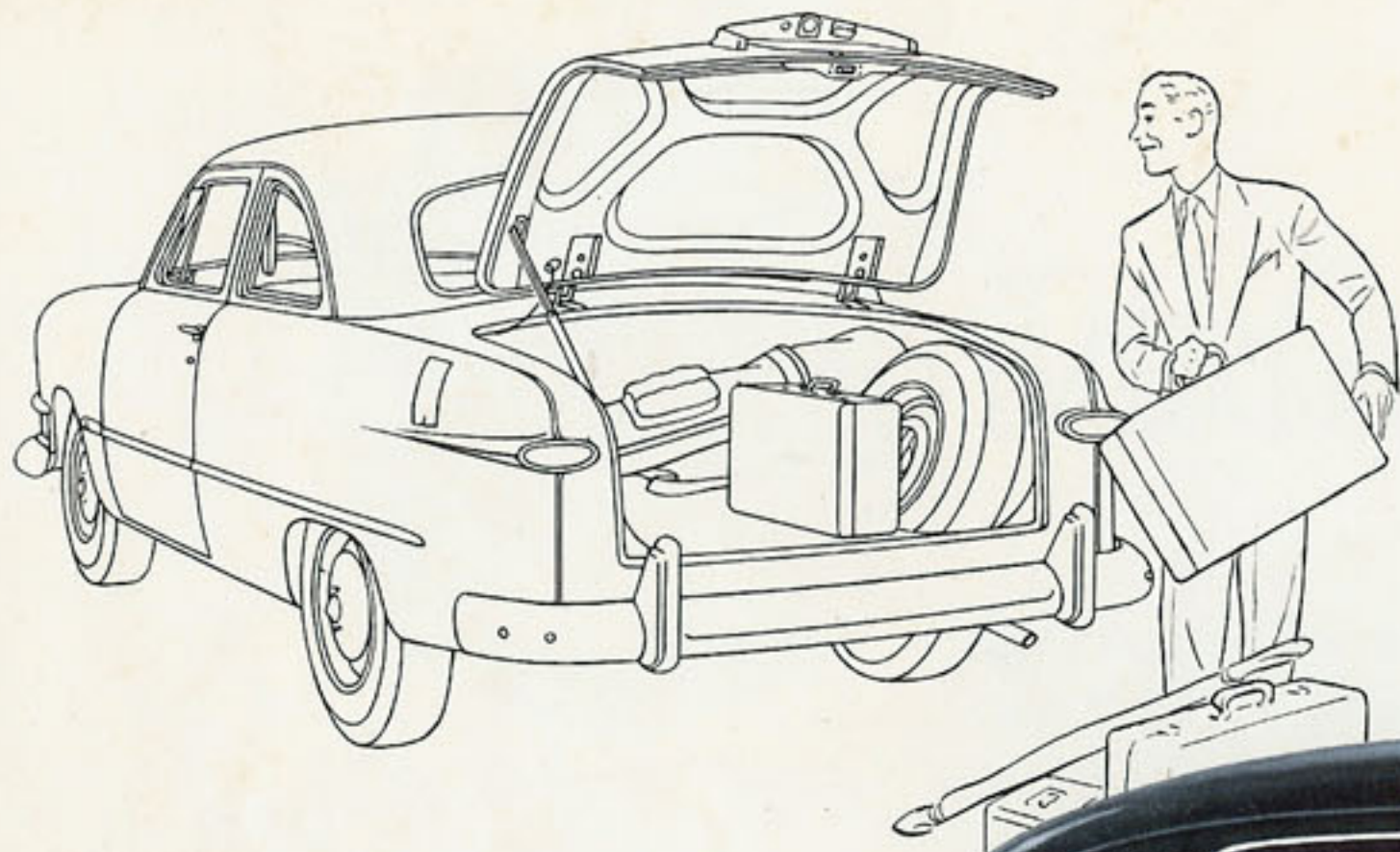

The 1950 Ford Custom Deluxe Club Coupe

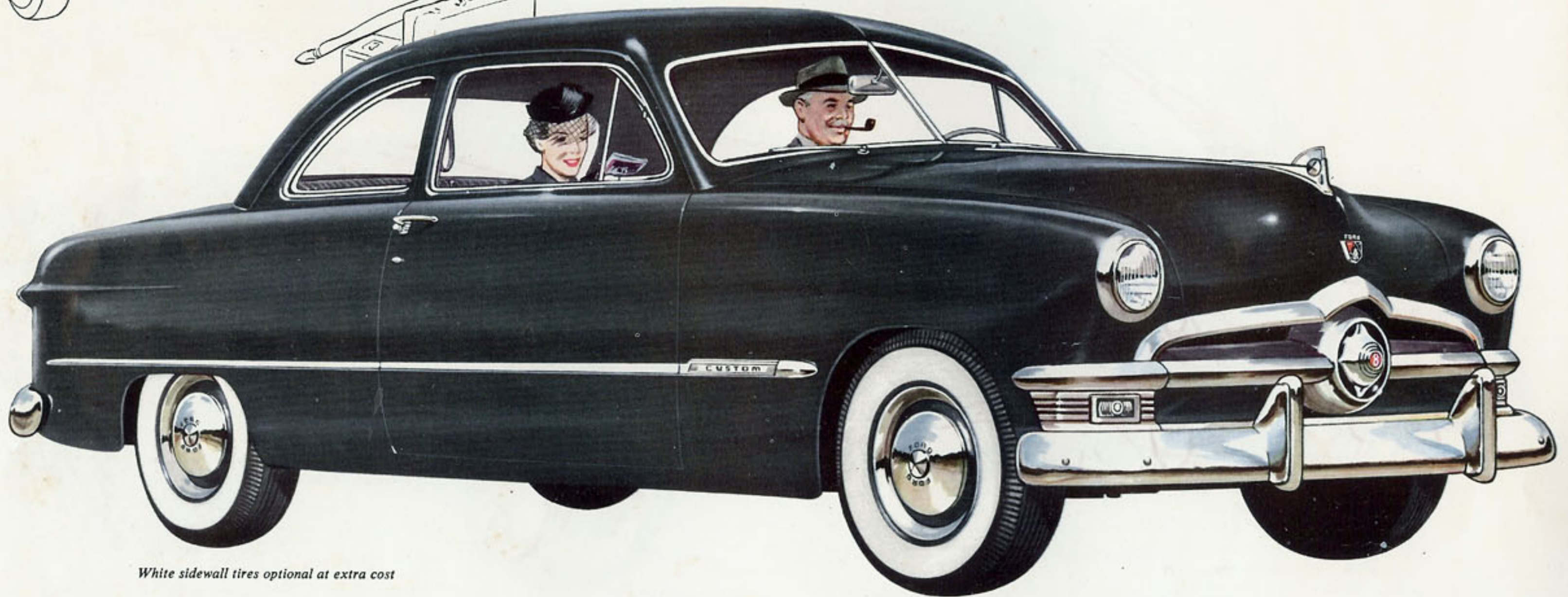

White sidewall tires optional at extra cost

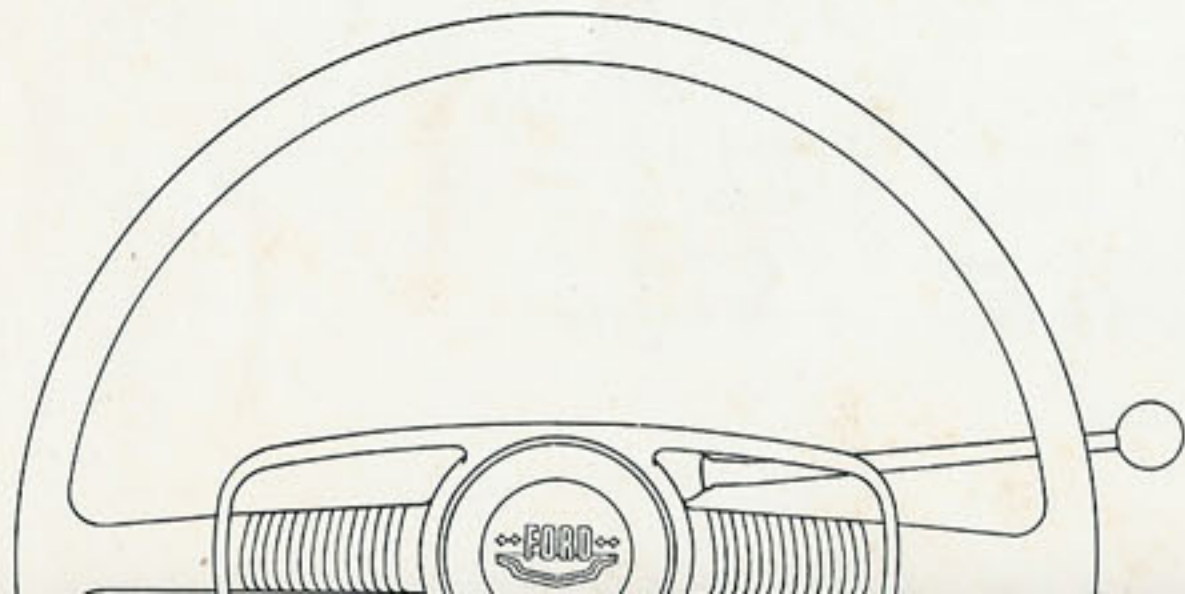

Here's a roomy, smart car that's a pleasure to drive. Like every '50 Ford, it has additional heavier sealer at 41 points which gives it greater interior quietness and protection. Like every '50 Ford, it has King-Size Brakes safety-sealed against water and dust. And they're easier acting—require 35% less pedal pressure.

The 1950 Ford Deluxe Business Coupe

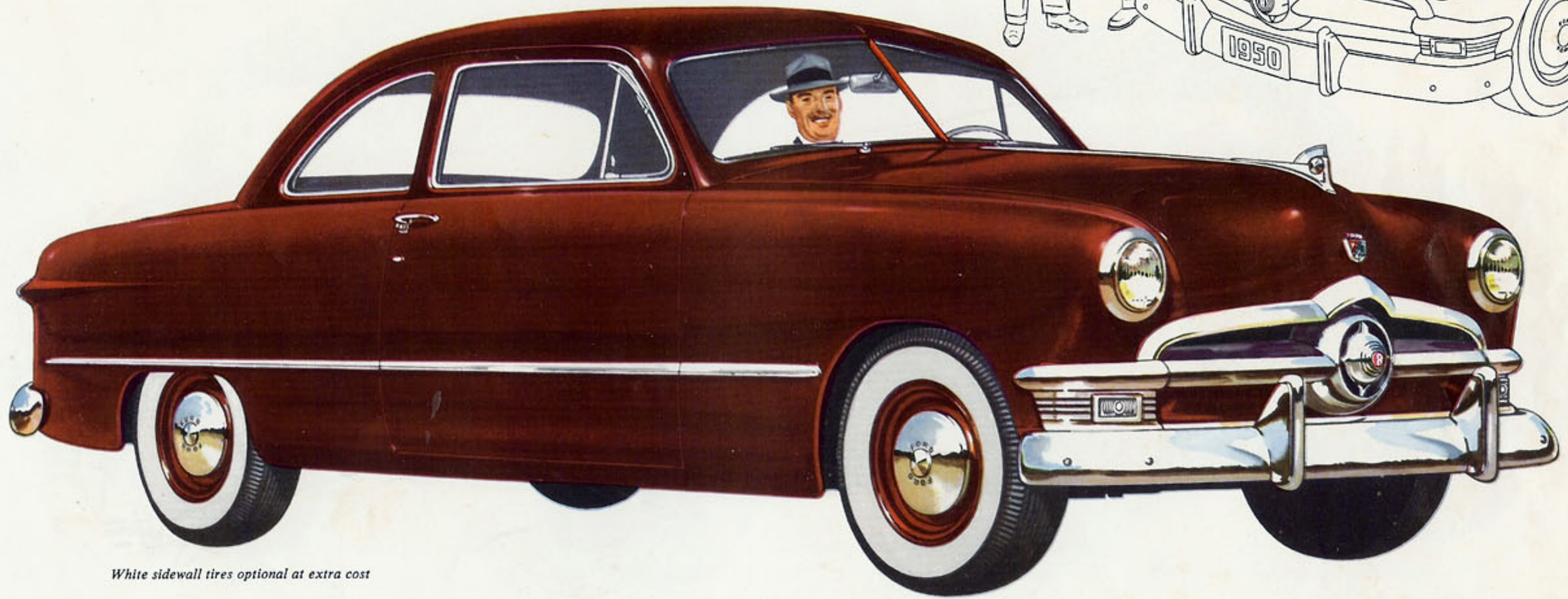
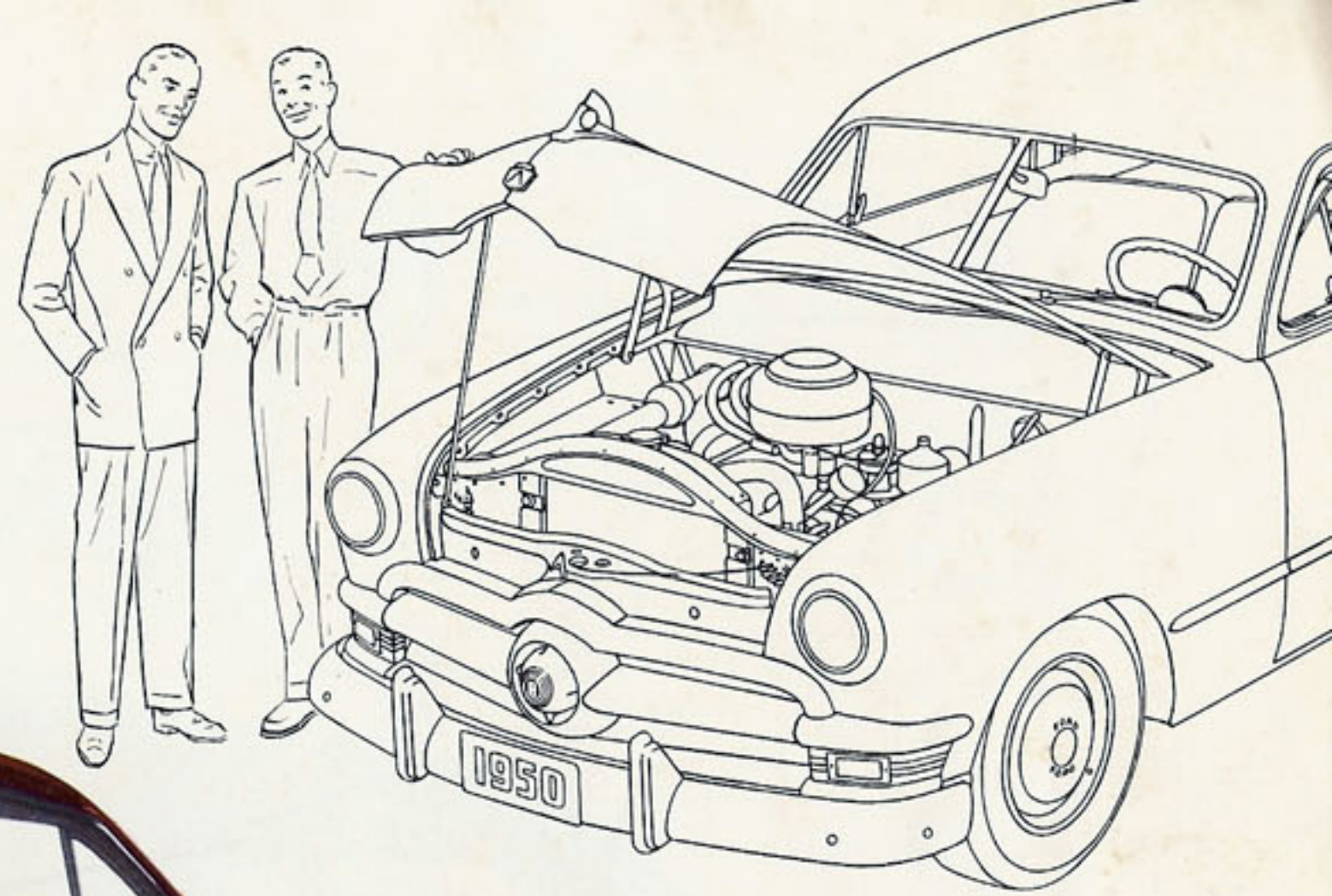

White sidewall tires optional at extra cost

This smart-looking car serves for both pleasure and business because it's so much fun to drive and so downright practical. There's roomy, easily accessible storage space behind the front seat and over 28 cu. ft. of usable space in the luggage compartment. It's a two-purpose car, but it really means business.

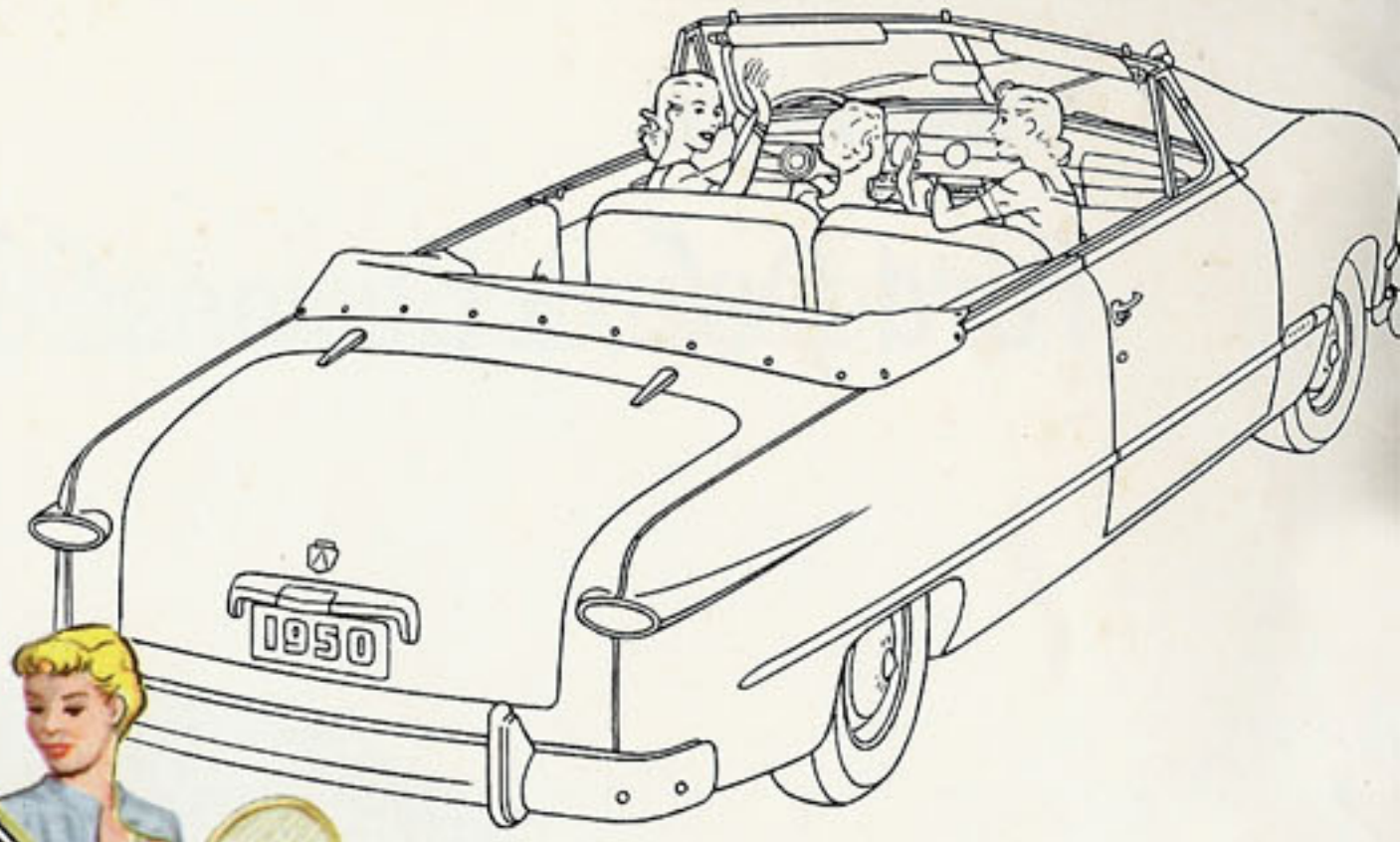
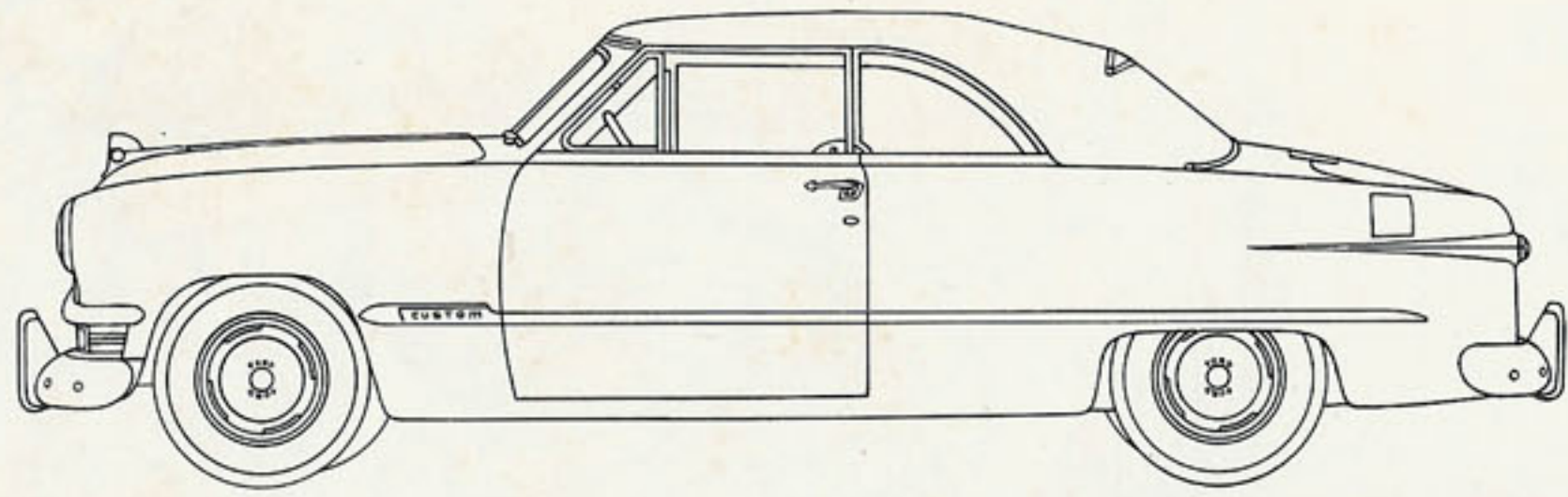

White sidewall tires optional at extra cost

The 1950 Ford Custom Deluxe Convertible Coupe

If there's a touch of gypsy in your soul . . . if you like the sun and the wind and the open road . . . you'll surely thrill to this sleek, stunning convertible. A slight touch of the finger, and the snug top goes up or down. A slight touch of the foot, and you're sailing off to faraway places behind Ford's smooth, easy power.

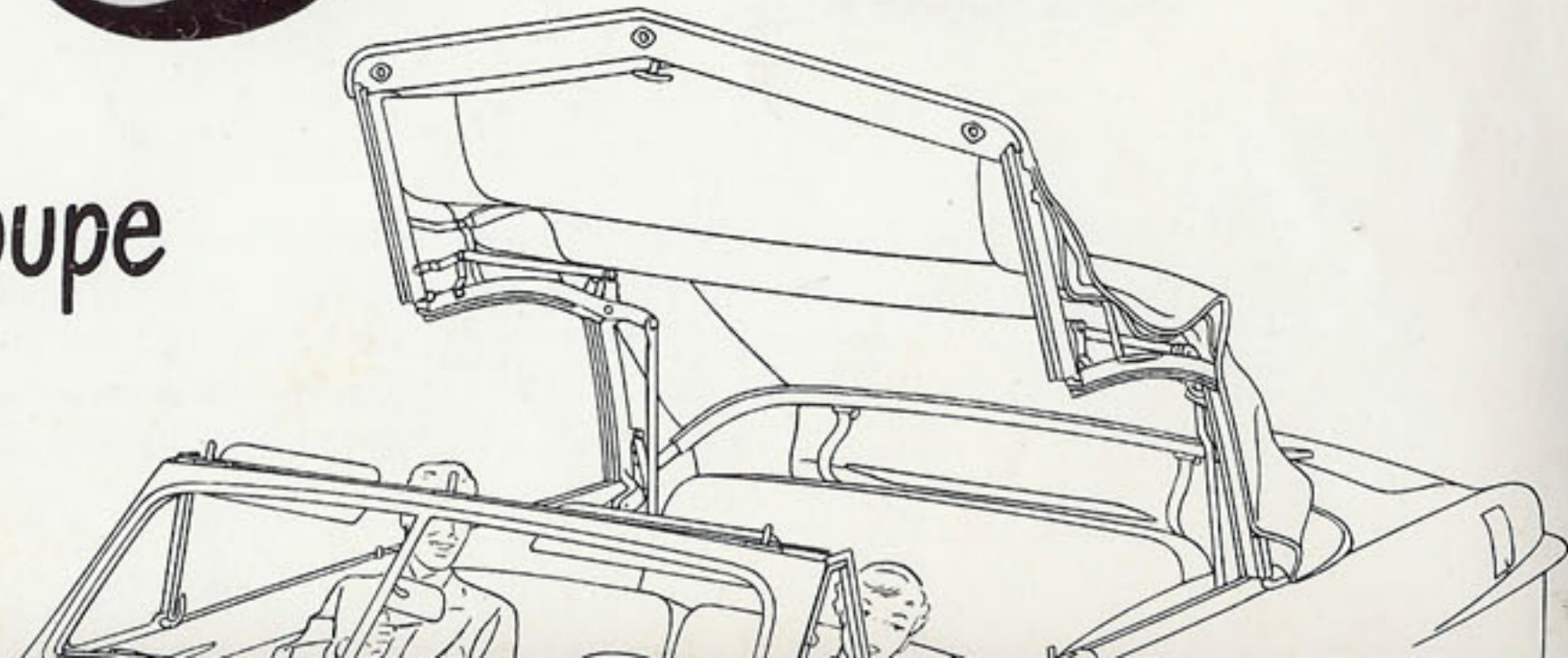

The 1950 Ford Custom Deluxe Station Wagon

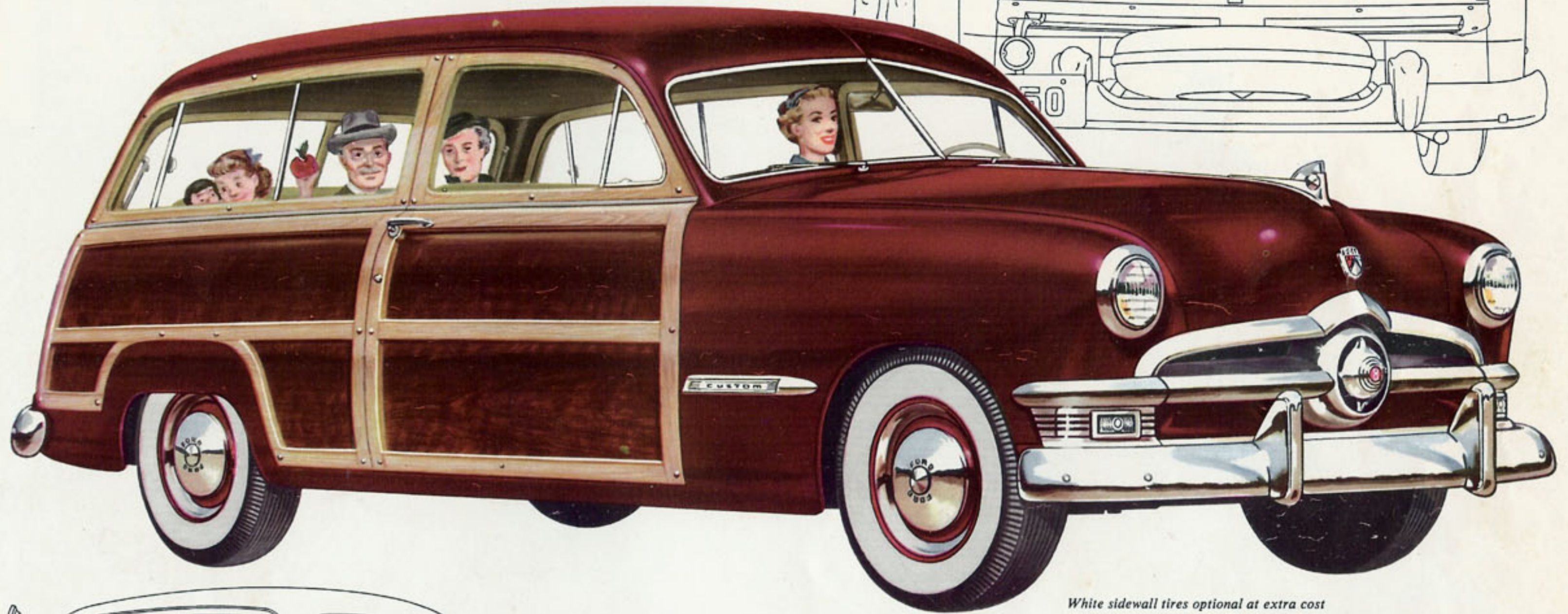
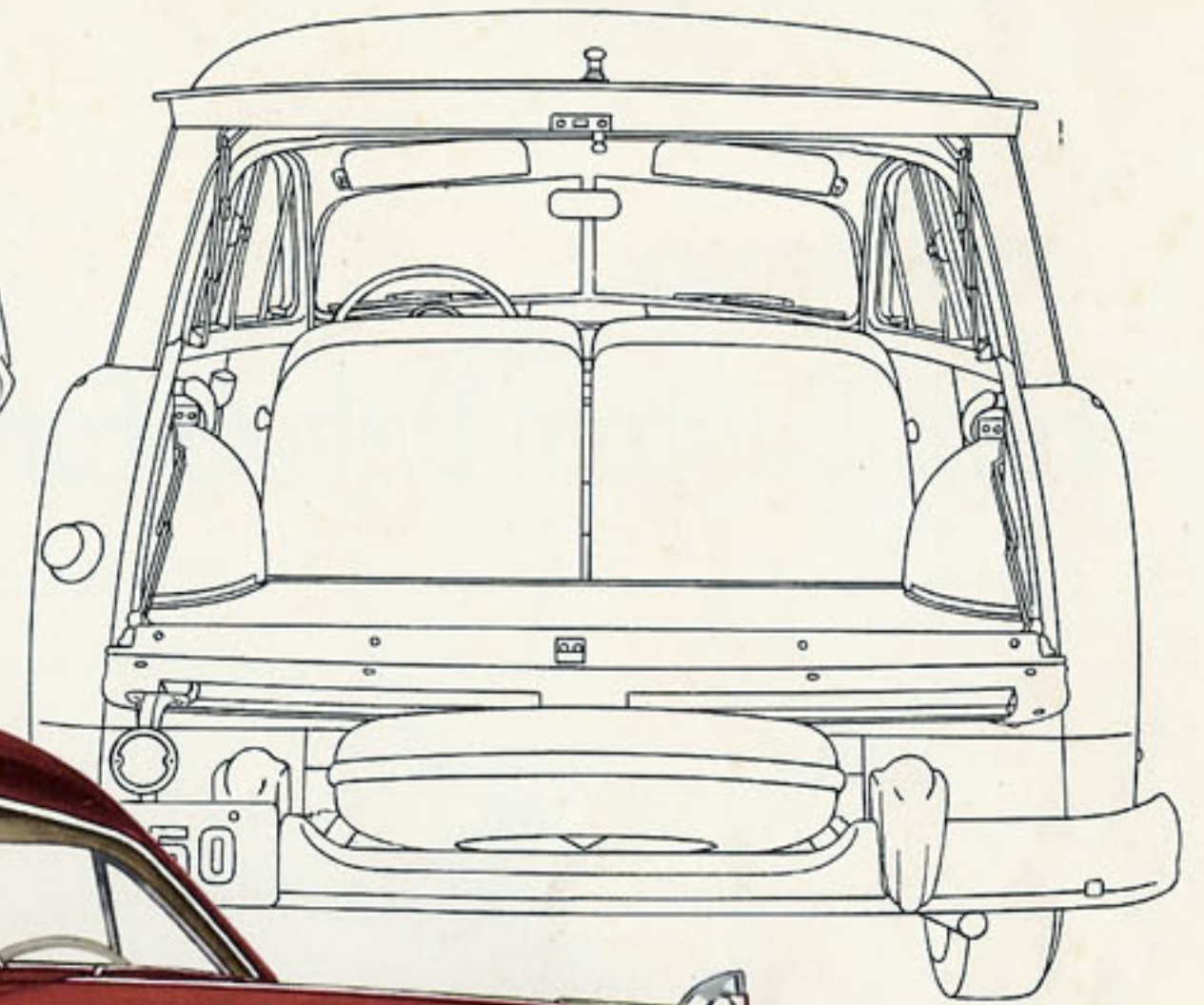

White sidewall tires optional at extra cost



Handsome is as handsome does. You'd never think anything so good looking could be so useful! This new Ford Station Wagon takes eight people anywhere in style and comfort . . . or totes loads up to a half ton with ease. The two rear seats can be removed in a matter of minutes. Its two-door design, and its molded plywood panels bolted to the all-steel body, make for extra safety.

**The 1950
Ford Custom Deluxe Fordor Sedan**

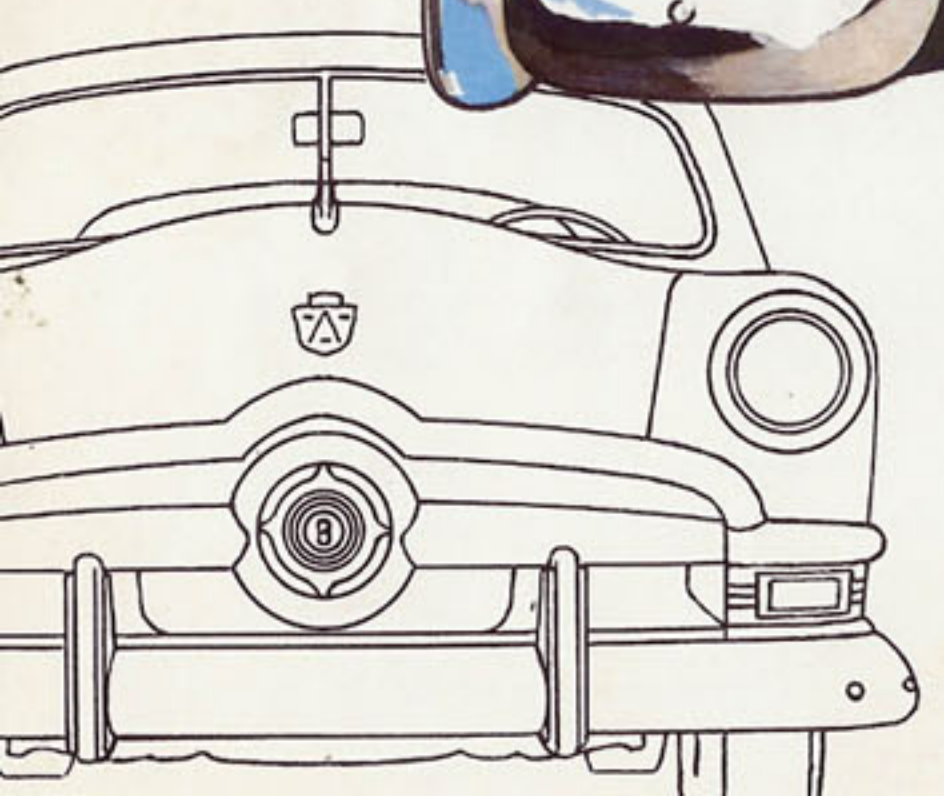
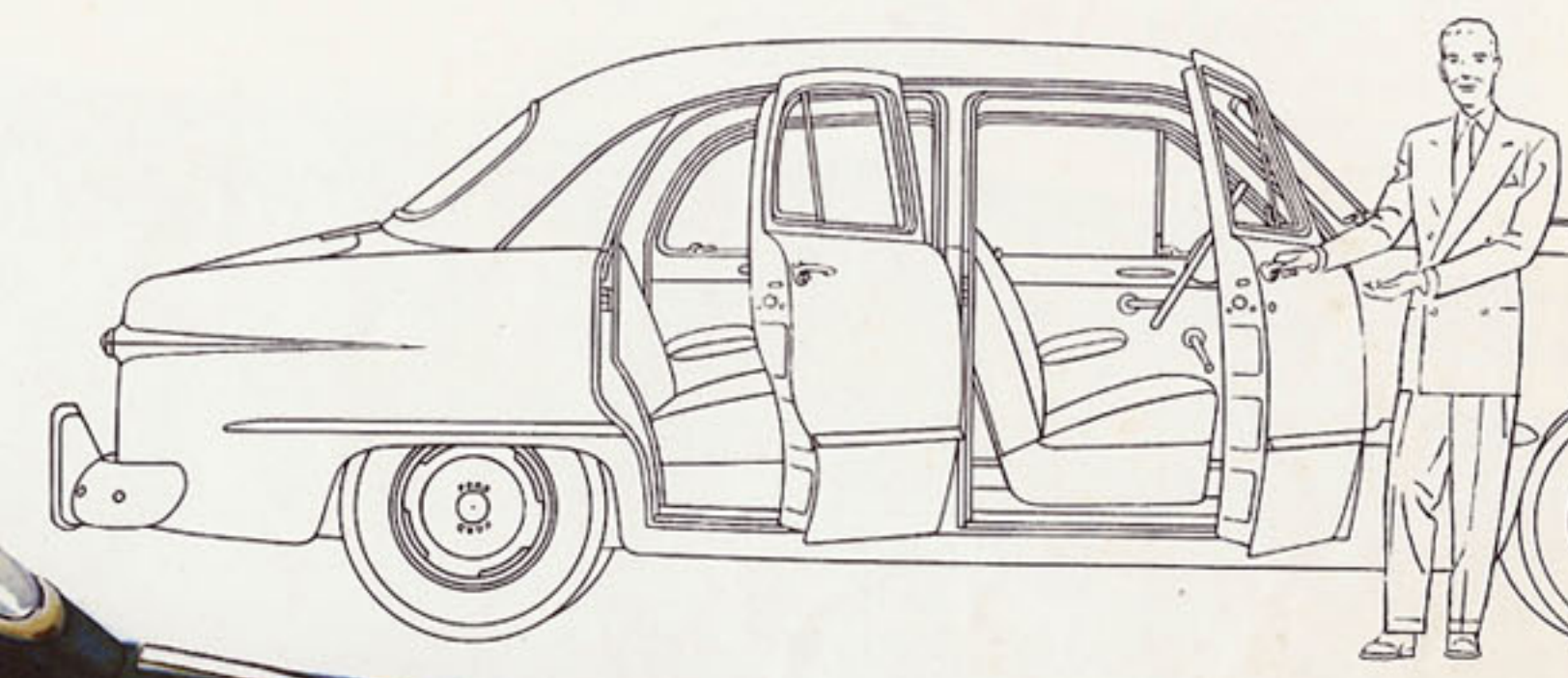
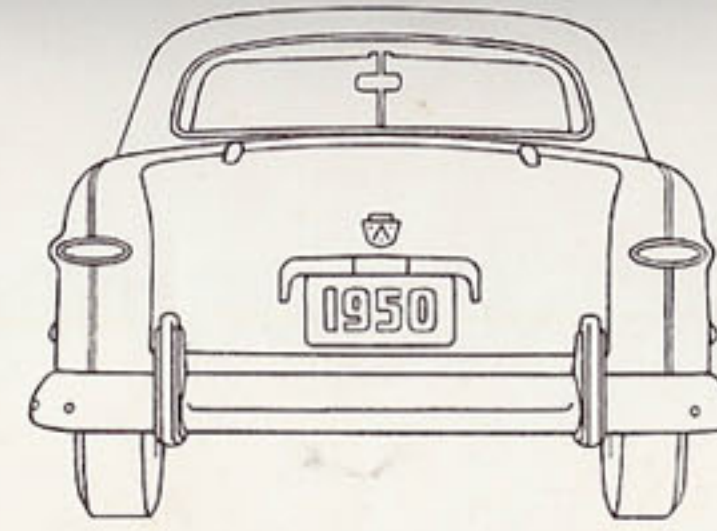

White sidewall tires optional at extra cost

Here's another Ford model that brings you dozens of outstanding features you've been looking for. Take the spacious new interior with luxurious new upholstery in clean sparkling colors. Take the "Picture Window" Visibility with nearly 19 square feet of glass area. Take the "Deep Deck"

Luggage Locker with its 22.9 cubic feet of usable space (opened by a trigger-type latch). Take the colorful instrument panel styled for greater convenience and beauty. But, better still, take a ride in this '50 Fordor and you won't want to take anything less than a Ford for your money.

The Fordor Sedan is also available in the Ford Deluxe series

Every Detail has Quality

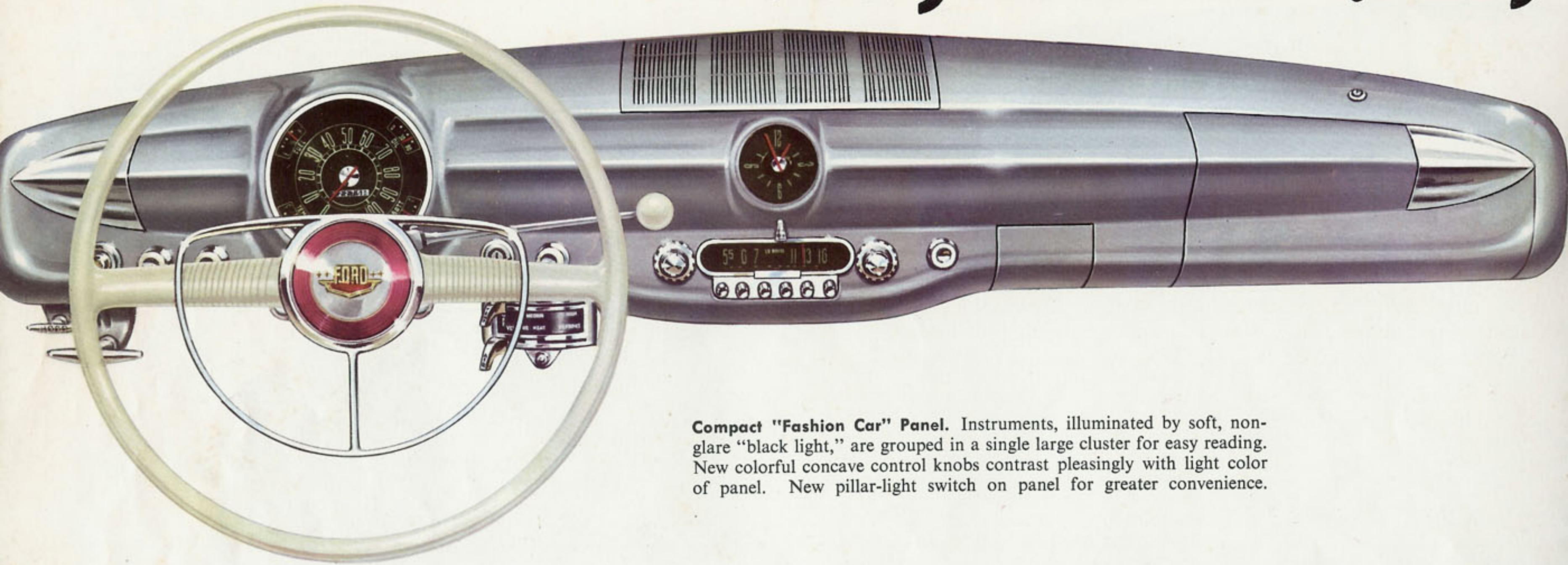

Compact "Fashion Car" Panel. Instruments, illuminated by soft, non-glare "black light," are grouped in a single large cluster for easy reading. New colorful concave control knobs contrast pleasingly with light color of panel. New pillar-light switch on panel for greater convenience.

Rich, New Medallion on hood and rear deck adds another note of beauty to Ford's "Fashion Car" styling.

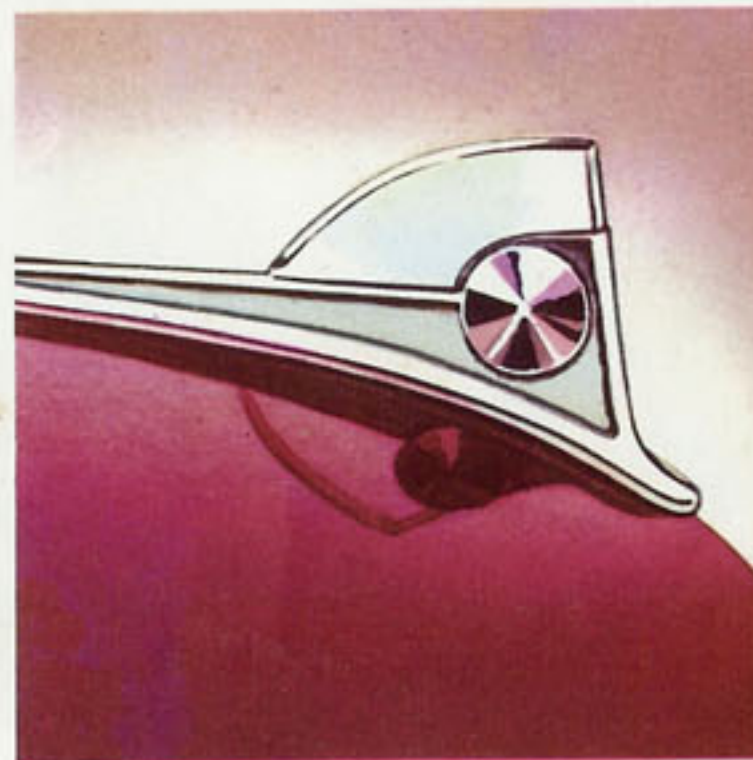

Hood Ornament of new design gives a smart touch of distinction to Ford's broad, sweeping hood lines.

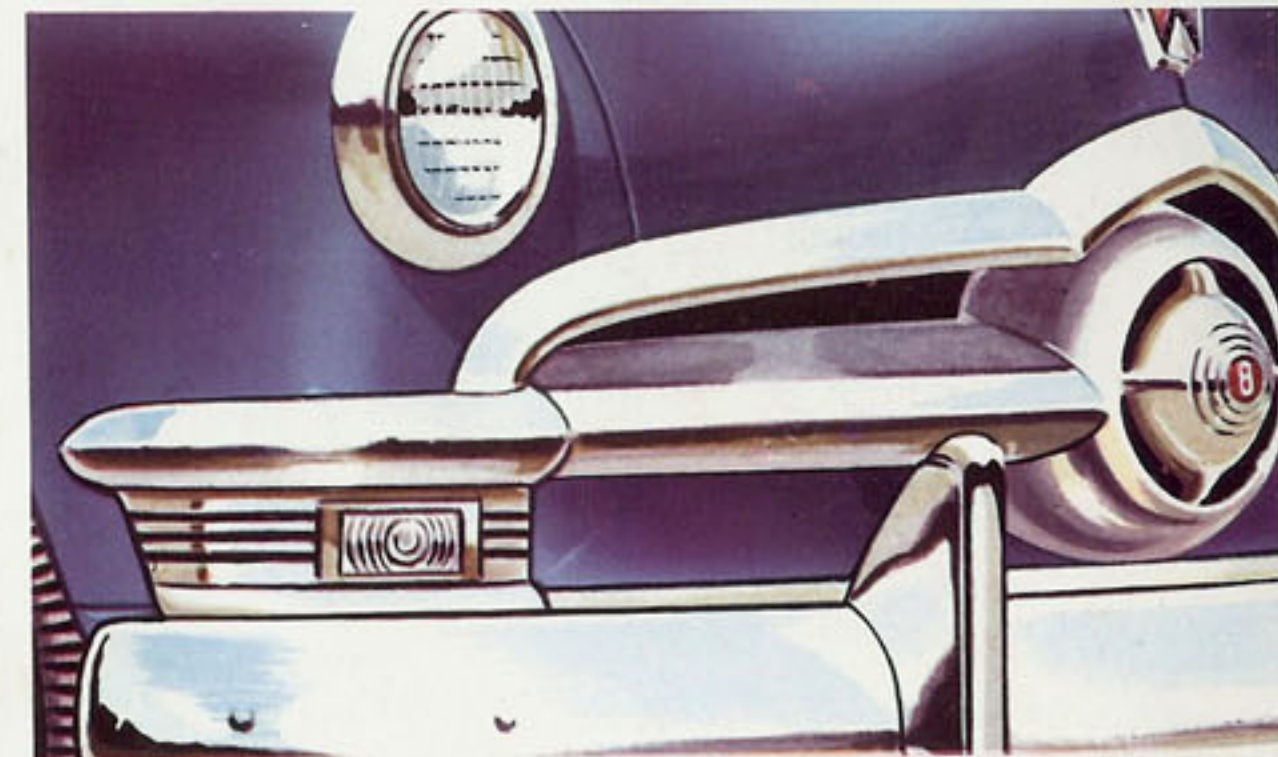

Parking Lights are now re-positioned and re-styled—another touch of beauty you'll like! New bumper guards are more graceful. New front end styling makes Ford more than ever America's "Fashion Car."

you can See ... Hear ... Feel

Yes, the 1950 Ford is 50 ways finer! You'll find a newly designed ceiling for greater head room. New non-sag front seat springs and foam rubber cushion for firm, buoyant comfort. New push-button door handles, new rotary door latches and new trigger-type rear deck handle. New colorful instrument panel and interior trim. New arm rests and finger-grip door closers. But take the wheel of this '50 Ford. Feel and hear the difference. You'll agree that it's the one *fine* car in the low-price field.

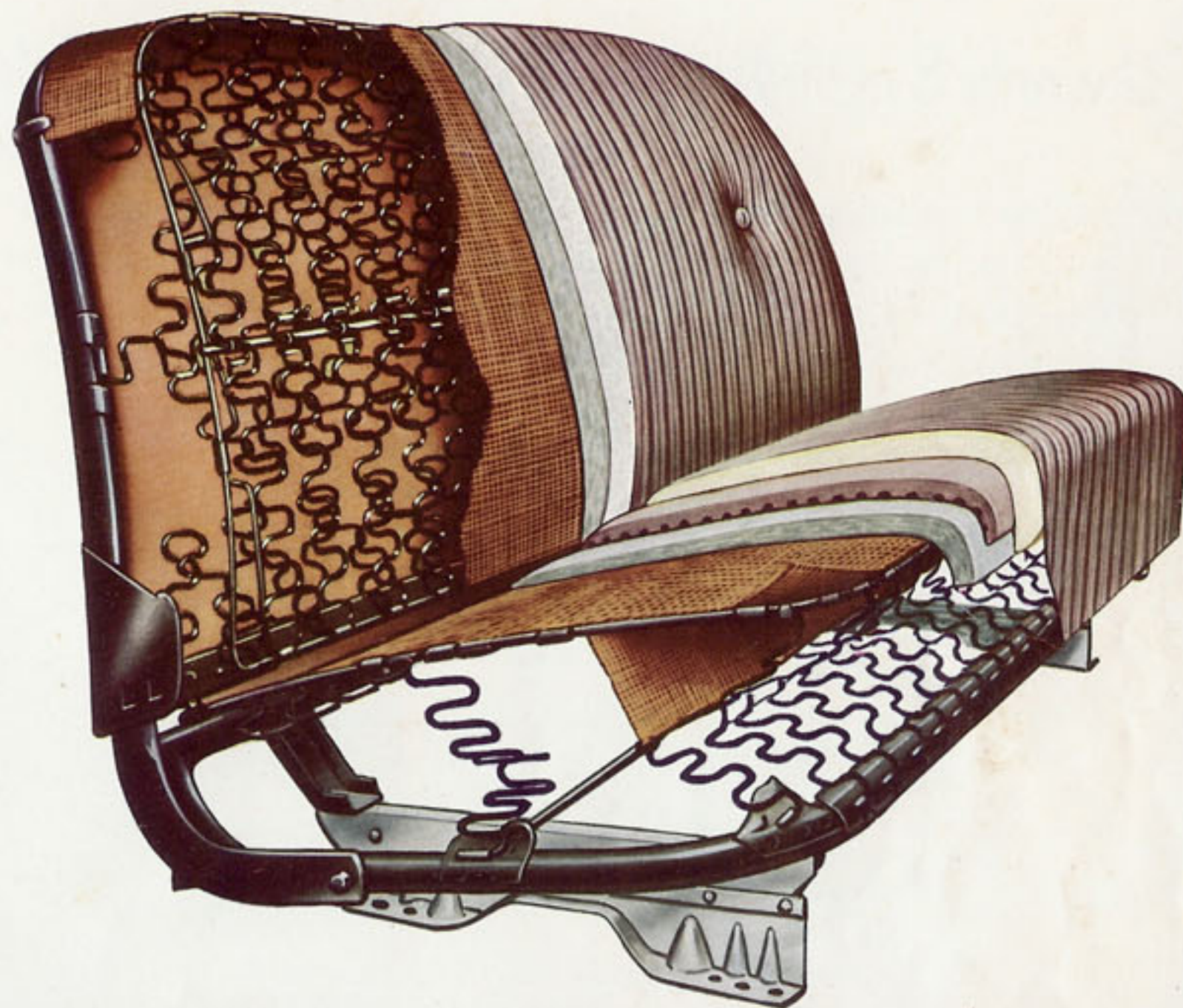

New Non-sag Front Seat. New non-sag front seat springs are firmly buoyant, hold their shape. Foam rubber front seat cushion is another new feature that gives long-lived comfort.



New Rotary Door Latch—the same type used in costliest cars. Feather-light touch closes doors solidly and securely.

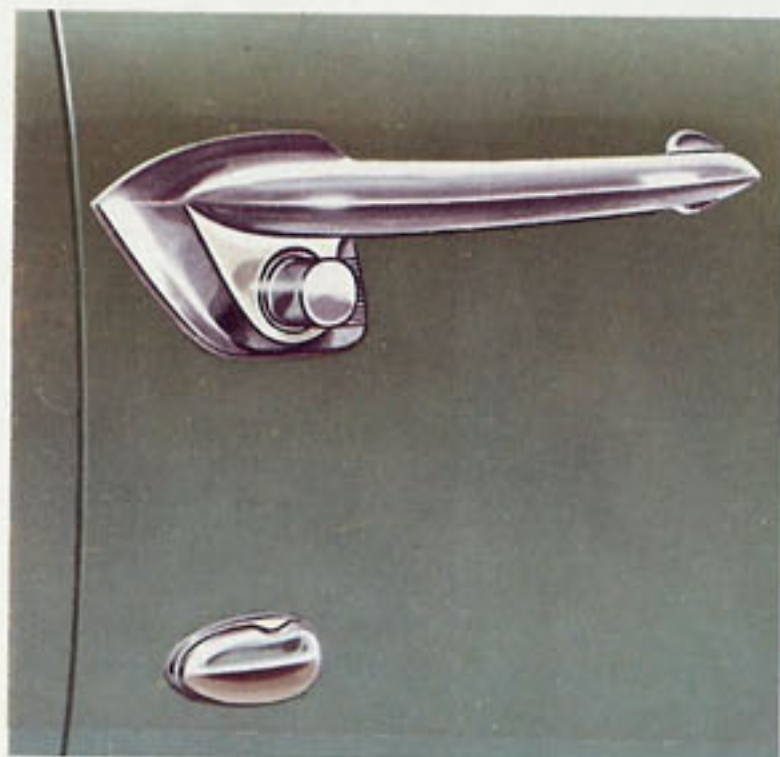

Push-button Door Handle anchored at both ends. A touch of a button is all it takes—and you can't catch your sleeve.

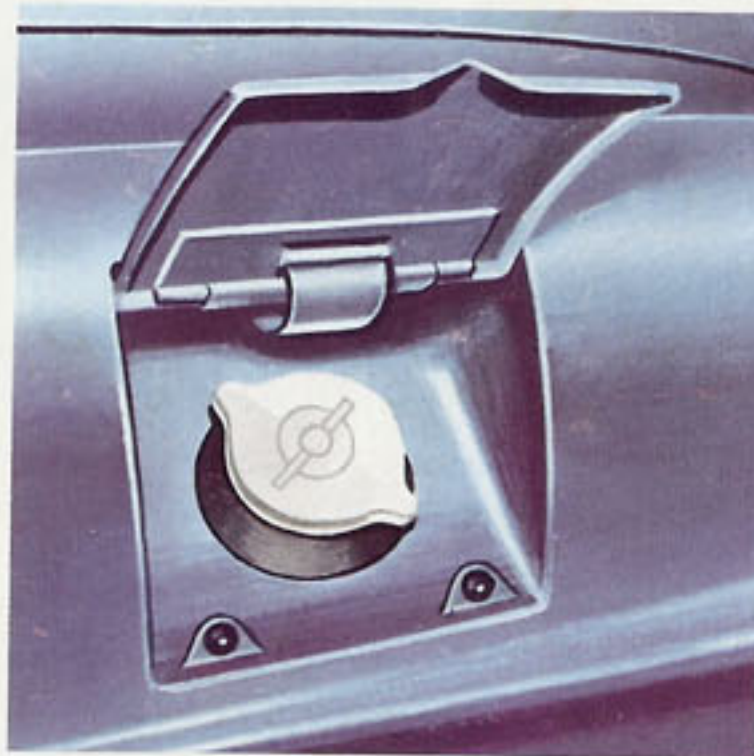

New Gas Filler Tube and Cover. New vent tube helps prevent spilling. Cover is flush with body when closed.



New Deck-Lid Handle incorporates new trigger-type latch. Makes attractive frame for license plate. Permits easy access to roomy, weather-sealed luggage compartment.

The new exclusive 100 h.p. V-8

the only 8 cylinder engine in the low price field

The '50 Ford brings you power such as you've never felt in a low-priced car. The 100-h.p. V-8 engine is the same type engine now featured in America's costliest cars. It's backed by Ford's experience in building over 10,000,000 V-8's—more than all other makers of V-8's combined! It delivers its 100 horsepower so silently you can actually talk in whispers while driving at highway speeds!

Dual Downdraft Carburetor—it's like two carburetors in one—assures more effective vaporization, quicker, smoother acceleration.

"Deep Breath" Manifold—has scientifically designed passages that assure even distribution of fuel.

New Three-blade Fan—scoops in more air at lower, quieter speeds.

Diaphragm-type Fuel Pump—top-mounted at cool rear location to help prevent vapor lock.

"Power Dome" Combustion Chambers—help fuel burn more evenly, more efficiently, for greater economy.

New Super-fitted Pistons—designed to start quiet and run quiet.

New Pressure Spray Lubrication of cylinder walls through new oil squirt holes in connecting rods.

New Camshaft Design—its lobes are designed for quieter valve operation.

Gear-type Oil Pump—has helical teeth for long-lived, quiet, positive operation.

New Timing Gear—it's made of "hushed" material for extra quietness.

New Accessory Drive—with pulleys and belts designed and arranged for best balanced, most efficient operation.

"Equa-Flo" Cooling—assures uniform temperatures for all parts of the engine.

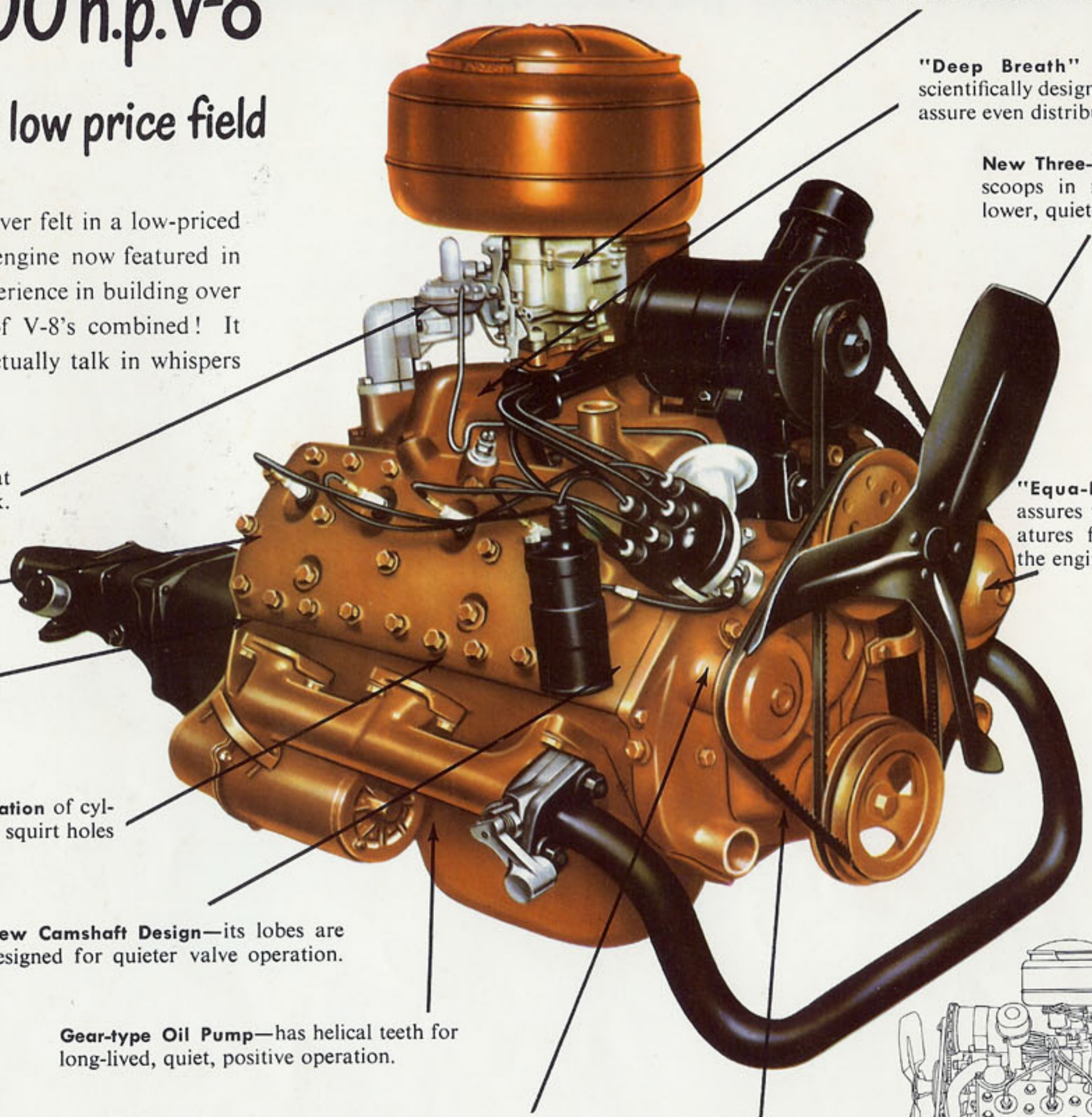
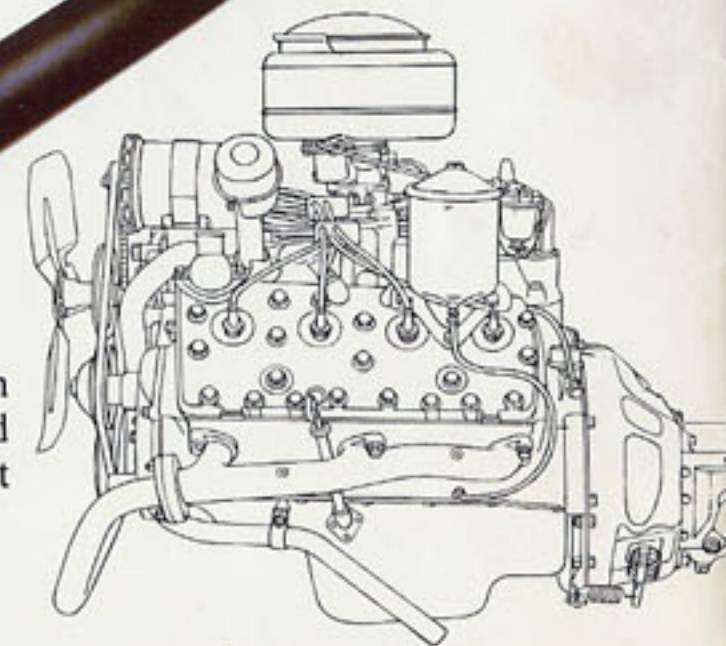
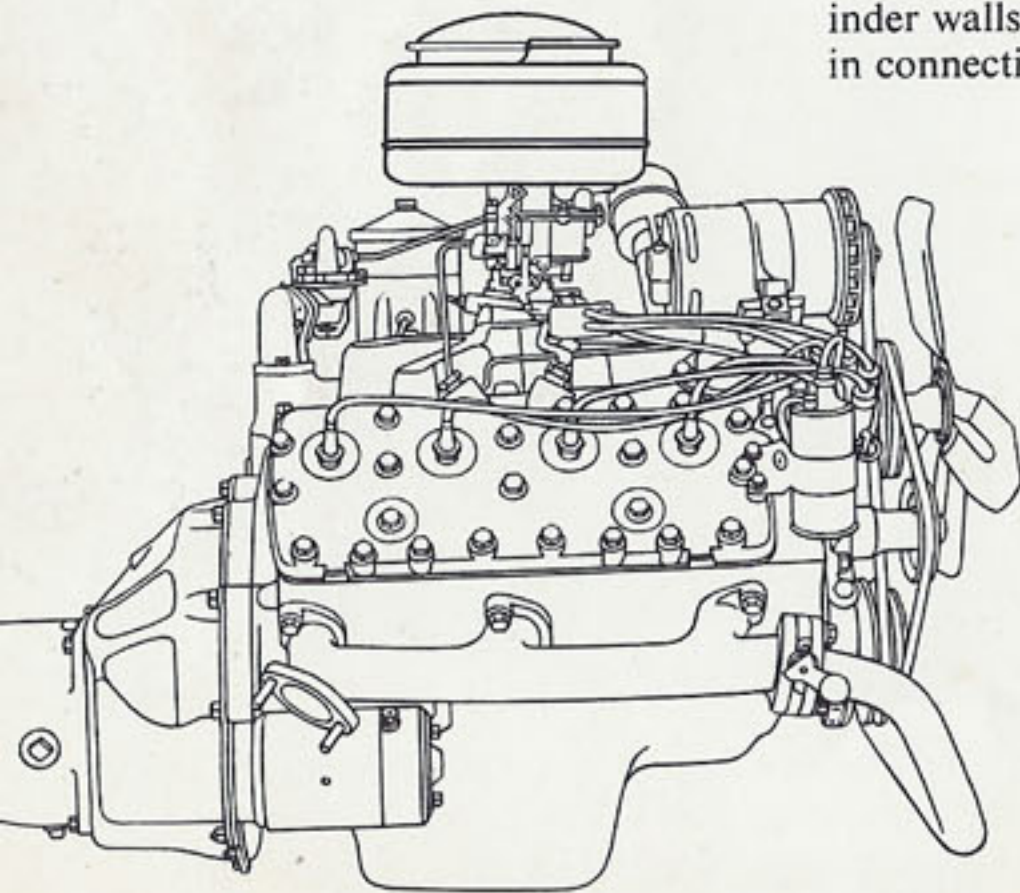

Ford's Chassis...Quality-Built for Safety and Comfort

For '50, Ford brings you a quieter, safer, more comfortable ride. Ford's completely integrated chassis design combines such factors as proper balance between front and rear springs, correct ratio of front and rear braking effects, low center of gravity, proper weight distribution, and easy, positive steering control for excellent roadability. This "inside story" shows you other reasons why the '50 Ford is the one *fine* car in its field.

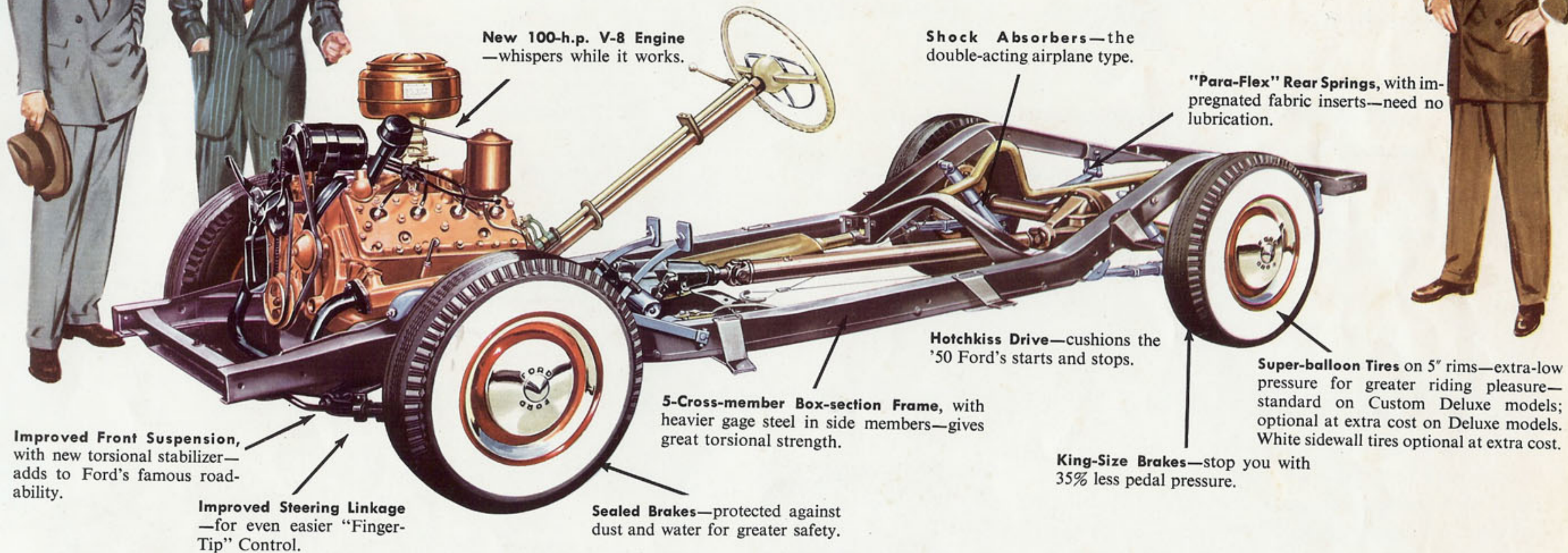

New 100-h.p. V-8 Engine
—whispers while it works.

Shock Absorbers—the
double-acting airplane type.

"Para-Flex" Rear Springs, with im-
pregnated fabric inserts—need no
lubrication.

Hotchkiss Drive—cushions the
'50 Ford's starts and stops.

Super-balloon Tires on 5" rims—extra-low
pressure for greater riding pleasure—
standard on Custom Deluxe models;
optional at extra cost on Deluxe models.
White sidewall tires optional at extra cost.

King-Size Brakes—stop you with
35% less pedal pressure.

5-Cross-member Box-section Frame, with
heavier gage steel in side members—gives
great torsional strength.

Sealed Brakes—protected against
dust and water for greater safety.

Improved Front Suspension,
with new torsional stabilizer—
adds to Ford's famous road-
ability.

Improved Steering Linkage
—for even easier "Finger-
Tip" Control.

Long life has been added everywhere—to the
engine, frame and body.

With the '50 Ford's "Mid Ship" Ride, you sit between
the wheels in the level-riding center section. Bumps
are erased by Ford's "Hydra-Coil" Springs in front
and "Para-Flex" Springs at the rear. You'll enjoy the
smoothest ride you've ever known!

Extra Ease . . . Ford Overdrive*

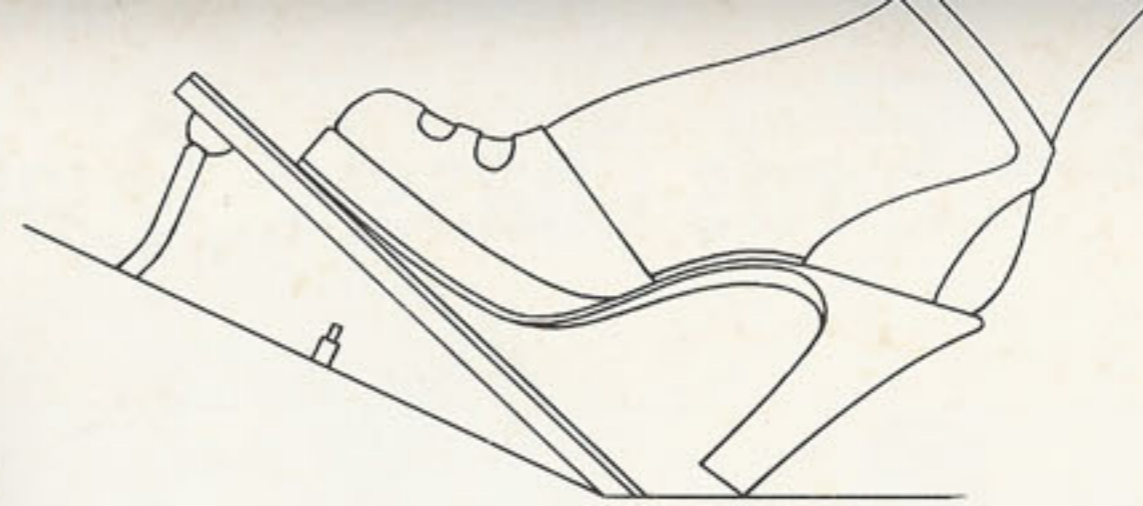
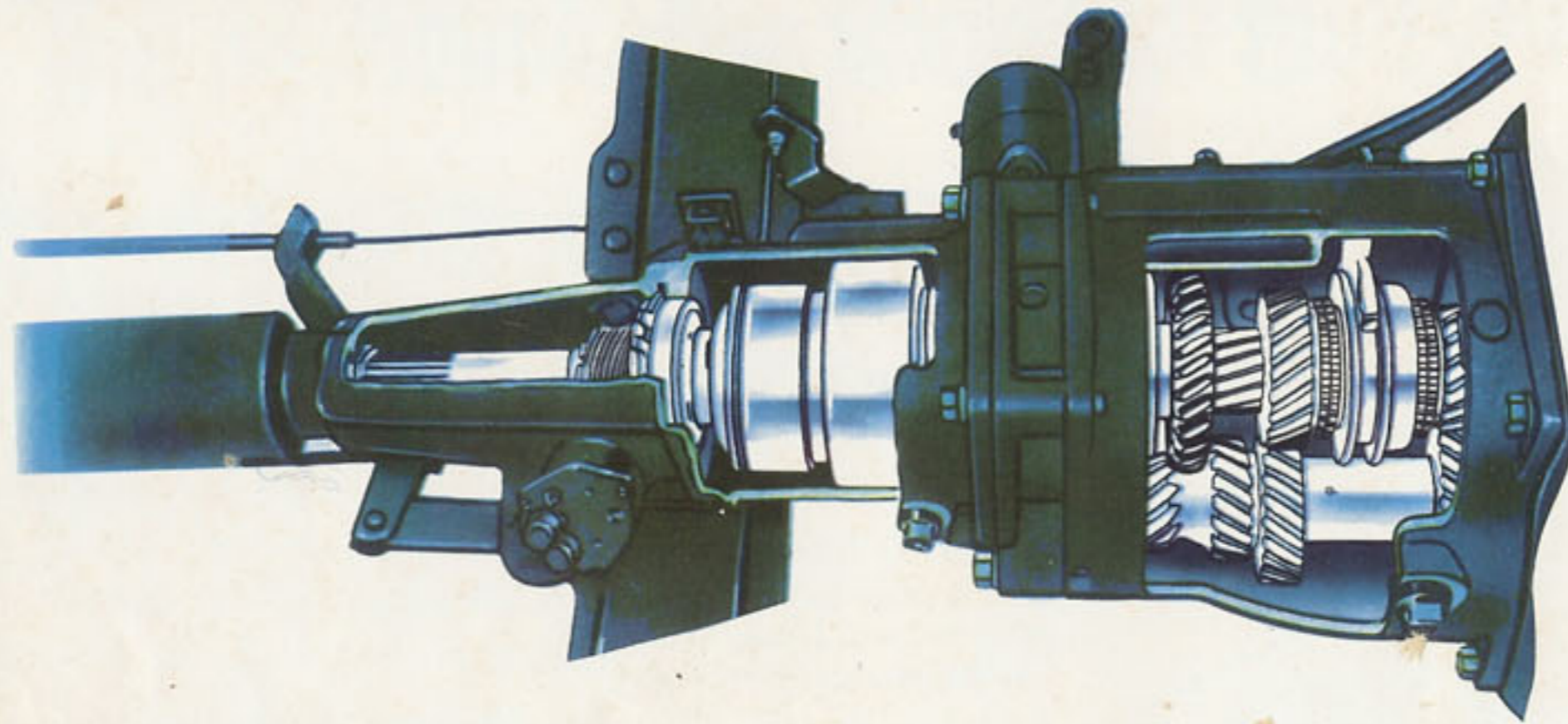

Here's an optional extra that pays off in savings and smoothness. It's an automatic fourth speed or cruising gear. Let up on the accelerator pedal at any speed above 27 m.p.h. and Overdrive engages. Engine speed drops 30% while the car speed remains unchanged. And should you require a burst of extra power, simply push through on the accelerator and you return automatically to third gear.

This table shows the engine speeds at various road speeds for cars with and without the Ford Automatic Overdrive.

Car Equipped with:	Combined Ratio	ENGINE SPEED (rpm) at:			
		30 mph	40 mph	50 mph	60 mph
STANDARD TRANSMISSION Operating in Third Gear	3.73 to 1	1385	1845	2305	2770
AUTOMATIC OVERDRIVE Operating in Overdrive	2.87 to 1	1065	1420	1775	2130
AUTOMATIC OVERDRIVE Not operating in Overdrive	4.10 to 1	1520	2025	2535	3040

Extra Comfort . . . Ford "Magic Air" Heater*

Winter or summer—driving fast or slow—Ford's "Magic Air" Temperature Control keeps you comfortable. New heater and ventilator controls are conveniently arranged, clearly marked, and simple to operate. System includes a powerful, two-speed blower with high speed circulation for fast winter warm-ups, and fast, efficient defrosting.



Ford's new "Magic Air" Heater Control, simplifies "picking your weather."

*Optional at extra cost.



Higher speed blower motor increases air flow 25%. New distributing box improves air circulation. Defroster openings are 44% wider.

Specifications:

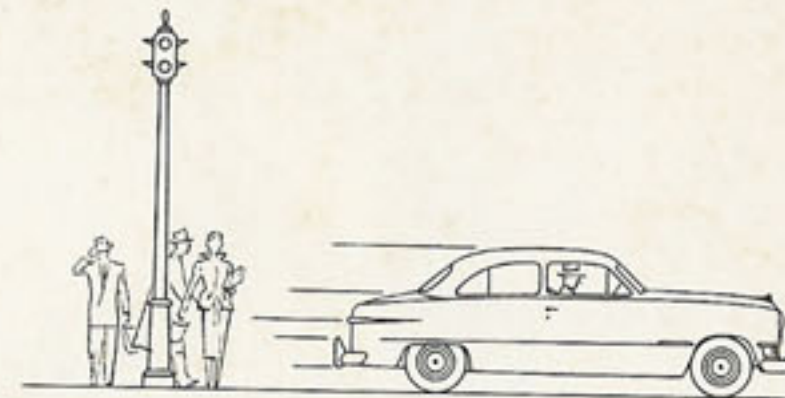

V-8 ENGINE: 100 brake h.p.; $3\frac{3}{16}$ " bore, $3\frac{3}{4}$ " stroke; 32.5 taxable h.p.; "Equa-Poise" mounting; 4-ring, tin-plated, aluminum alloy pistons with steel struts; new cam design; laminated composition material timing gear; "Loadomatic" ignition.

FULL-PRESSURE LUBRICATION: crankcase capacity, 4 qts. normal refill, 5 when filter element replaced; oil filter at extra cost; helical gear oil pump; directed-flow crankcase ventilation.

FUEL SYSTEM: capacity, 19 gal. on Station Wagon, 16 on other models; oil bath air cleaner at extra cost; dual downdraft carburetor; automatic heat control valve.

"EQUA-FLO" COOLING SYSTEM: capacity 21 qts.; 22 with heater; full-length water jackets surround each cylinder completely; balanced-type thermostats and recirculation by-passes; dual water pumps; unique 3-blade fan; pressure-type radiator cap.

CLUTCH AND TRANSMISSION: semi-centrifugal type clutch; 3-speed helical gear transmission with synchronizers for second and third speeds.

AUTOMATIC OVERDRIVE: optional at extra cost; cuts in at 27 mph (approx.); cuts out at 21 mph (approx.); ratio 0.70 to 1.

DOUBLE-DROP FRAME: box-section side rails and 5 cross members. Convertible and Station Wagon frames specially reinforced.

INDEPENDENT FRONT WHEEL SUSPENSION: swinging link type with coil springs, double-acting, tubular, hydraulic shock absorbers and new, one-piece, rubber-mounted stabilizer.

REAR SUSPENSION: semi-elliptic leaf springs, longitudinally mounted; rubber bushings at shackles and brackets and impregnated inserts between tips of upper leaves eliminate need for lubrication; double-acting, tubular, hydraulic shock absorbers.

REAR AXLE: semi-floating type; hypoid gears. Gear ratios without Overdrive: 3.91 to 1 standard, 4.27 to 1 optional on Station Wagon; all other models 3.73 to 1 standard, 4.10 to 1 optional. Gear ratios with Overdrive: Station Wagon 4.27 to 1; other models 4.10 to 1.

"MAGIC ACTION" HYDRAULIC BRAKES: 4-wheel duo-servo type; composite steel and cast iron drums; molded linings; lining area, 182.5 sq. in. on Station Wagon, 176 sq. in. on other models. Rear service brakes, actuated by dash-mounted T-handle, serve as parking brake.

SYMMETRICAL STEERING LINKAGE: worm and roller steering gear with needle-bearing mounted, triple-tooth roller; gear ratio, 17.7 to 1; over-all steering ratio, 23.2 to 1; 18" diameter, 2-spoke steering wheel.

WHEELS AND TIRES: 6.00 x 16 4-ply tires on $4\frac{1}{2}$ " rims standard on Deluxe models; 6.70 x 15 4-ply tires on 5" rims standard on Custom Deluxe models except Station Wagon; 7.10 x 15 6-ply tires on 5" rims standard on Station Wagon. 6.70 x 15 4-ply tires on 5" rims optional at extra cost for Deluxe models. Standard tires have black sidewalls. All tires available with white sidewalls at extra cost.

EXTERIOR DIMENSIONS: 114" wheelbase; 56" tread, front and rear (Station Wagon rear 60"); over-all length 196.7" (Station Wagon 208").

INSTRUMENTS AND CONTROLS: Fuel level, oil pressure, battery charge and water temperature indicators grouped around speedometer in single cluster. Starter push-button; combination exterior light and instrument panel light switch; interior light switch; windshield wiper control; ventilating duct controls; T-handle controls for hood latch and parking brake; finger-tip gear shift lever; head lamp beam control switch;

rubber-padded clutch and brake pedals; treadle-type accelerator pedal.

1950 FORD V-8 LINE: Tudor Sedan, Fordor Sedan and Business Coupe in Deluxe models; Tudor Sedan, Fordor Sedan, Club Coupe, Convertible Club Coupe and Station Wagon in Custom Deluxe Models.

11 BODY COLORS: Cambridge Maroon Metallic, Sheridan Blue, Sunland Beige, Palisade Green, Dover Gray and Black for all models; Bimini Blue Metallic, Osage Green Metallic, and Hawthorne Green Metallic for Custom Deluxe models only. Matador Red Metallic and Sportsman's Green for Convertible only.

DELUXE EQUIPMENT: Dual windshield wipers, twin horns, one sun visor, rear view mirror, ash tray and glove compartment in instrument panel; foam rubber pad in front seat cushion; mohair or broadcloth upholstery; interior light on left center pillar with switch on instrument panel.

CUSTOM DELUXE EQUIPMENT: (In addition to or in place of items listed for Deluxe models). Horn ring and Custom Deluxe horn button; two sun visors; locking glove compartment door; chrome finials on instrument panel; cigar lighter, electric clock (at extra cost); chrome exterior reveal molding at windshield on all models and at rear window of Sedans and Club Coupe; wheel trim rings (at extra cost); one ash tray in rear compartment of Fordor, 2 in other models; two assist straps in Tudor and Club Coupe; robe cord in Fordor. Extra-quality mohair or broadcloth upholstery in hard-top models; seven leather or leather and bedford cord upholstery combinations for Convertible; genuine leather on driver's seat, vinyl on passenger seats in Station Wagon; two interior lights (one in Convertible and Station Wagon) operated automatically by either front door or by manual switch; arm rests on both front doors; arm rests at both sides of rear seats (except Convertible and Station Wagon).

Ford Dealers Know Fords Best

... so always bring your Ford Back Home for Service

The 1950 Ford with its built-in future will be even more economical to maintain for years and years. But you should protect your Ford by taking it regularly to your Ford Dealer, the man who knows it best.

With Ford-trained Mechanics, Genuine Ford Parts, Factory-approved Methods, and Special Ford Equipment, he'll keep your Ford in finer shape and save you time, trouble and money. So, make it a habit to see your Ford Dealer for regular Ford care.

The Ford Division of the Ford Motor Company, whose policy is one of continuous improvement, reserves the right to change at any time, specifications, design or prices without incurring obligation.

There's a *Ford* in your future...with a future built in!



Look for this sign



The Ford V-8 --- for 1950

**Deluxe and
Custom Deluxe**

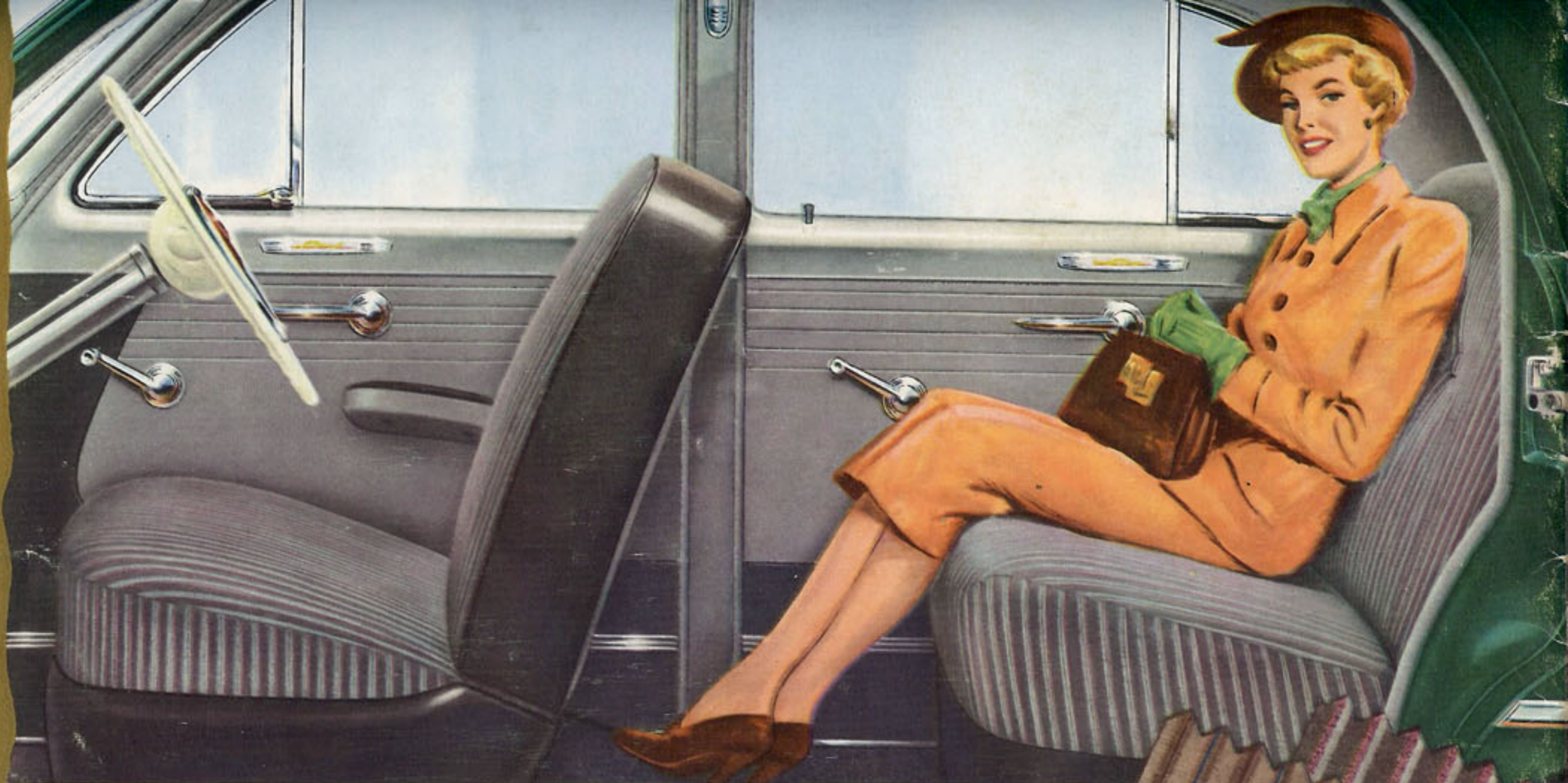

Luxurious Interior has room for six big people, with the most hip and shoulder room in its field.

A decorator's dream - styled for comfort

Look at the **luxurious interior** of the '50 Ford. You'll love the smart, bright, new upholstery fabrics. You have your choice of long-wearing broadcloth or mohair—both in new, sparkling clear colors. Inside or out, you can't beat a '50 Ford for "Fashion Car" beauty or fine car comfort.

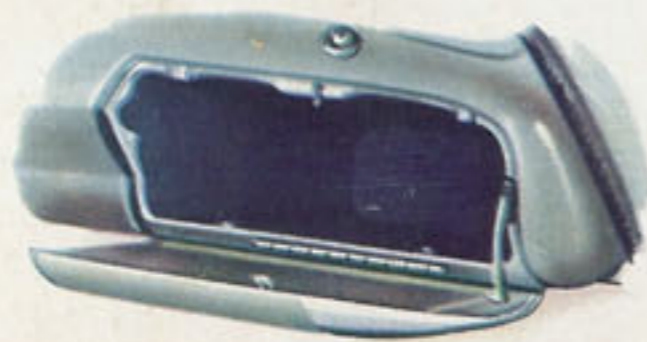

New Double-walled Glove Compartment Door has new piano-type hinge. It looks better—and it works better.

