

2011
SUPER DUTY®



ford.com



BETTER THAN EVER.



F-350 LARIAT Crew Cab 4x4 in Dark Blue Pearl/Sterling Gray Two-Tone with available equipment

Introducing the 2011 Super Duty.[®]

That's right. **AMERICA'S MOST CAPABLE PICKUP** is now even better. Tested-tough new powertrains – designed, engineered and built by Ford – give Super Duty class-leading fuel economy,¹ plus best-in-class diesel horsepower and torque.² Best-in-class maximum towing and payload capacities² get the job done when no one else can. Standard trailer sway control helps increase your towing confidence. It's no wonder F-Series has been America's best-selling truck for 33 years running. And this rugged workhorse is built to make it a whole lot more.

¹Based on Ford drive-cycle tests of comparably equipped 2011 Ford and 2010/2011 competitive models.

²Class is Full-Size Pickups over 8500 lbs. GVWR. Based on comparison of 2011 MY competitive models. GVWR and GCWR when properly equipped.

2011 SUPER DUTY[®]

ford.com



TESTED TOUGH

to **OUTWORK** all the rest.



F-350 LARIAT Crew Cab 4x4 in Golden Bronze/Pale Adobe Two-Tone with available equipment

Already proven – beyond any other.

The new 2011 Super Duty® endured more torture testing than any Ford Truck before it – including over 10 million cumulative miles on the **MOST TESTED POWER STROKE® DIESEL ENGINE EVER**. A world-class team put it through a groundbreaking battery of computer simulations, lab and real-world tests – running it for **THOUSANDS OF HOURS ON END**. In extreme conditions. Scorching heat. Bitter cold. Loaded to the max. Up the steepest grades. All to confirm that this truck is far more than the sum of its parts.

Super Duty is built to be the best – bringing you the **BEST DIESEL AND GAS FUEL ECONOMY** of any truck in its class¹ – plus lots of other capabilities and features only Ford can deliver.

BEST IN CLASS

- Max. Horsepower and Torque
- Max. Conventional Towing: 17,500 lbs^{2,3}
- Max. 5th-Wheel Towing: 24,400 lbs³
- Max. Payload: 7,070 lbs³
- Fuel Economy: Diesel and Gas

CLASS EXCLUSIVES

- Live-Drive Power TakeOff (PTO)⁴
- 5th-Wheel/Gooseneck Trailer Tow Prep Package⁴
- Standard trailer sway control on both SRW and DRW
- LCD Productivity Screen⁴
- Standard Safety Canopy® System
- Ford Work Solutions™⁴
- Tailgate Step⁴

¹Class is Full-Size Pickups over 8,500 lbs. GVWR. Based on Ford drive-cycle tests of comparably equipped 2011 Ford and 2010/2011 competitive models. ²Available early 2011. ³When properly equipped. 17,500 on F-350 DRW and F-450. 24,400 on F-450 Pickup. 7,070 on F-350 DRW Regular Cab 4x2. ⁴Optional.

2011 SUPER DUTY®

ford.com



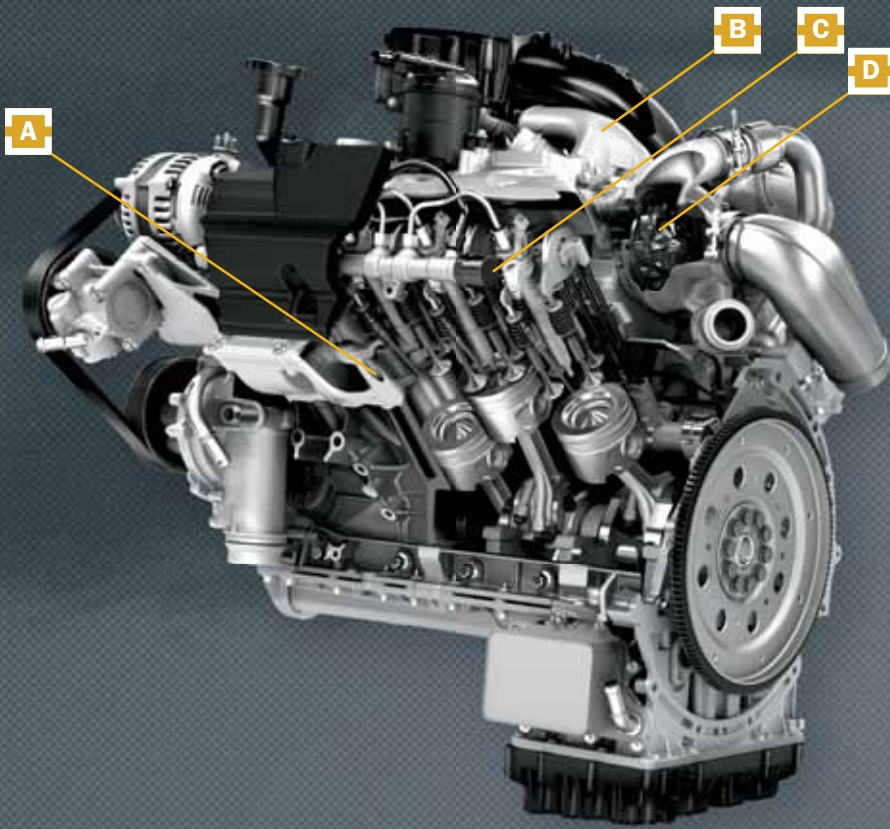

BEST DIESEL

fuel economy, power and torque IN THE CLASS.

Ford 6.7L Power Stroke® V8 Turbo Diesel.

Designed, engineered and built by Ford, this heavy-duty diesel helps Super Duty® deliver up to a **20% IMPROVEMENT IN FUEL ECONOMY** over the previous model, making it the best in its class! It also gives you best-in-class horsepower and torque. We're talking **400 HP** and a massive **800 LB.-FT. OF TORQUE**. That's a game-changing combination. And this **B20-CAPABLE** engine has already proven itself in over 10 million miles of cumulative testing. It's the **MOST TESTED POWER STROKE DIESEL ENGINE EVER**.

¹Based on Ford drive-cycle tests of comparably equipped 2011 Ford and 2010/2011 competitive models.

6.7L V8 DIESEL PERFORMANCE

14% MORE PEAK HP and **23% MORE PEAK TORQUE**, at lower rpm, than its predecessor.

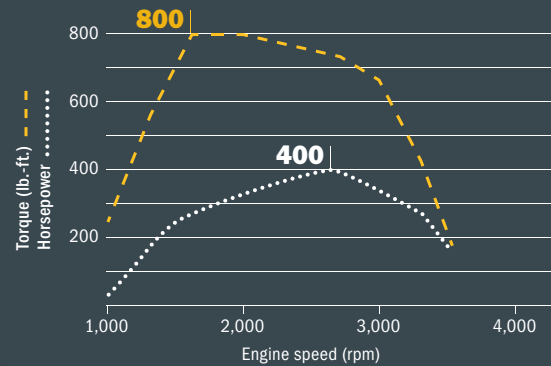

- A ALUMINUM CYLINDER HEADS** with precision dual water jackets reduce weight and improve cooling.
- B CLASS-EXCLUSIVE INBOARD EXHAUST AND OUTBOARD AIR INDUCTION** architecture helps reduce turbo lag.
- C COMMON-RAIL FUEL INJECTION SYSTEM**, operating at nearly 30,000 psi, uses precise control to provide optimum power, efficiency and noise, vibration and harshness (NVH) performance.
- D CLASS-EXCLUSIVE SINGLE-SEQUENTIAL TURBOCHARGER** uses the compact, efficient design of a dual-sided compressor wheel to help deliver maximum power quickly.
- ENGINE-EXHAUST BRAKING** helps provide better grade descent control with less brake and transmission wear and tear. Fully integrated with tow/haul mode, it provides increased engine braking at higher engine speeds.
- LOWEST NVH IN THE CLASS** with a notably quieter, more refined sound than ever before – the result of meticulous attention paid to the designs of the combustion system, the engine block and the turbocharger.
- CLEANEST SUPER DUTY DIESEL EVER** reduces nitrogen oxide (NOx) levels by more than 80% compared to last year.

2011 SUPER DUTY®

ford.com



6.2L V8 GAS PERFORMANCE

28% MORE STANDARD HP and **11% MORE STANDARD TORQUE** than its predecessor.

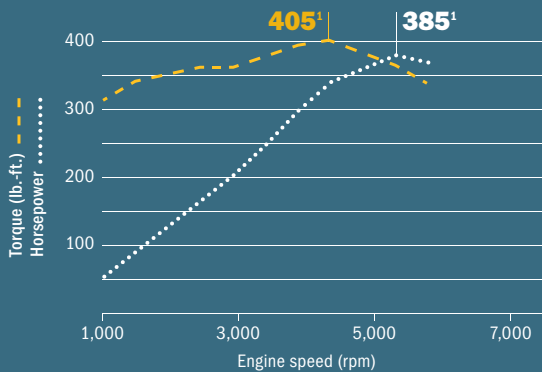

Certified to SAE J1349.

- A DUAL-EQUAL VARIABLE CAM TIMING** phases the intake- and exhaust-valve opening and closing events simultaneously to optimize fuel economy, low-end torque and peak horsepower.
- B 2 SPARK PLUGS PER CYLINDER** burn the fuel-air mixture more efficiently for better fuel economy and increased engine torque.
- C STIFF SOHC VALVETRAIN** with roller-rocker shafts and optimized camshaft-lift profiles produces significant low-rpm torque and enables an intake- and exhaust-port layout that leads to better breathing.
- D CYLINDER BLOCK DESIGN** is specifically engineered to optimize the efficiency of crankcase airflow, resulting in improved torque at higher engine speeds; cast-iron engine block and 4-bolt main bearing caps, with 2 additional cross bolts, provide extreme durability.
- PISTON-COOLING JETS** spray oil directly on the underside of the cast-aluminum pistons to keep them cool under extreme operating conditions; they also contribute to increased overall efficiency.

¹405 lb.-ft. of torque and 385 hp under 10K GVWR.
397 lb.-ft. of torque and 316 hp over 10K GVWR.

BEST GAS

**fuel economy,
power and torque
IN THE CLASS.**



Ford 6.2L V8 Gas Engine.

As the standard engine, this free-breathing Ford-built machine helps Super Duty® achieve up to **15% BETTER FUEL ECONOMY** than the previous base engine, making it the best in its class.² It also delivers best-in-class **385 HORSEPOWER** and **405 LB.-FT.¹ OF TORQUE**. The design features large valves and a large-bore, shorter-stroke approach – proven technologies inspired by Ford racing – that help improve its breathing.

And you can rest assured this all-new **E85-CAPABLE** engine is ready to get to work. The Ford powertrain team designed, engineered, built and torture-tested it themselves.

²Based on Ford drive-cycle tests of comparably equipped 2011 Ford and 2010/2011 competitive models.

2011 SUPER DUTY®

ford.com



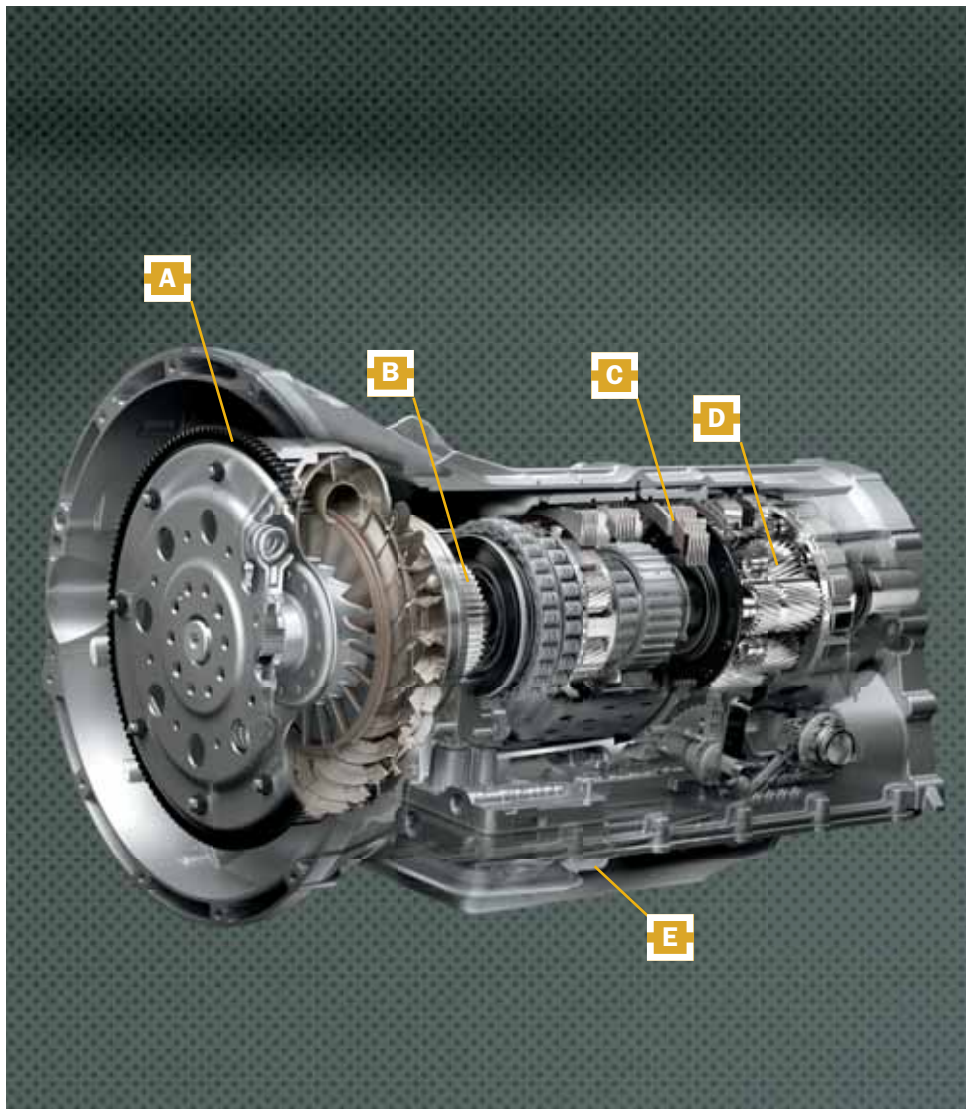

- A REDESIGNED TORQUE CONVERTER** with low-speed lockup capability (down to 900 rpm) enables the engine to run efficiently at lower rpm for improved fuel economy.
- B EXCLUSIVE LIVE-DRIVE POWER TAKEOFF (PTO) PROVISION**, available on the 6.7L Power Stroke® diesel, is the only one in the class that uses an output gear linked directly to the engine crankshaft to power upfits anytime the engine's running, whether you're in motion or at a stop.
- C HIGH-ENERGY FRICTION PLATES** are engineered with fluid lube paths to help improve cooling and wear resistance while minimizing torque loss.
- D BIGGER AND STRONGER GEARS** have a lower 1st-gear ratio for improved launch performance and uncompromising durability.
- E NEW HIGH-CAPACITY, HIGH-EFFICIENCY FLUID FILTER** extends fluid- and filter-change intervals up to 150,000 miles.
- **PROVEN POWER FLOW** provides close-ratio gearing for seamless shifting and a double-overdrive to help keep you in the power sweet spot for optimum performance and fuel economy.
- **HIGH-STRENGTH SINTER-METAL CARRIER** with patented Ford rocker one-way clutch is designed to easily handle the enormous low-end torque of the diesel engine and the high speeds of the gas engine.

HEAVY-DUTY

to **HARNESS** all the power.

Ford TorqShift® 6-Speed SelectShift Automatic.™

Blending the control of a manual with the convenience of an automatic, the SelectShift Automatic allows you to use its **FULL MANUAL MODE** to lock the torque converter and hold your chosen gear. Or utilize the **PROGRESSIVE RANGE SELECT** mode to lock out upper gears when the truck is heavily loaded or when towing on grades. Your options are open.

Designed, engineered and built by Ford, this Heavy-Duty transmission is filled with innovations, including an **ENHANCED TOW/HAUL MODE** that provides better control while hauling heavy loads or towing trailers, especially when descending steep grades. And it's all been proven over **10 MILLION MILES OF CUMULATIVE TESTING**.

2011 SUPER DUTY®

ford.com





F-450 LARIAT Crew Cab 4x4 in White Platinum Tri-coat/Pale Adobe Two-Tone with available equipment

PULLS IT OFF

like **NO ONE ELSE** can.

Super Duty® reigns supreme with best-in-class towing capabilities,¹ class-exclusive features and available systems like trailer sway control for **ULTIMATE TOWING CONFIDENCE**. A single touch of the brake pedal in tow/haul mode activates the integrated diesel engine-exhaust braking to help improve control with less wear and tear on the brakes and transmission.

BEST-IN-CLASS MAX. TOWING
Conventional: 17,500 LBS.²
5th Wheel: 24,400 LBS.²

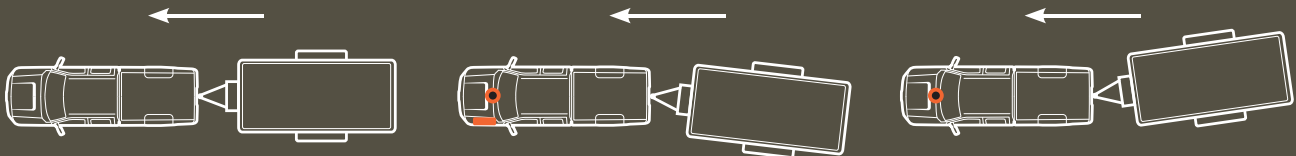

STANDARD TRAILER SWAY CONTROL² uses a yaw motion sensor to monitor the motions of your truck and detect trailer sway. When trailer sway is detected, the system can automatically react by selectively braking, helping you **MAINTAIN CONTROL** of both the truck and the trailer. Super Duty is the only truck in its class with this system standard on both SRW and DRW models.

¹When properly equipped. ²Available early 2011. ³Remember that even advanced technology cannot overcome the laws of physics. It's always possible to lose control of a vehicle due to inappropriate driver input for the conditions.

2011 SUPER DUTY®

ford.com





F-450 KING RANCH® Crew Cab in Royal Red/Pale Adobe Two-Tone with available equipment

PURPOSE-BUILT

to tow like a PRO.

A FACTORY-INSTALLED 5TH-WHEEL/GOOSENECK TRAILER TOW PREP PACKAGE offers you the strength of an under-the-bed frame crossmember and maintains a flat cargo bed floor. This patent-pending system is fully covered by a Ford Warranty;¹ and is compatible with the Ford Custom Accessory 5th-Wheel and Gooseneck Hitch Kits by Reese.²

B FACTORY-INSTALLED 5TH-WHEEL AND GOOSENECK HITCH KITS² (Gooseneck shown) are available to get your new Super Duty[®] trailer-ready. See your Ford Dealer for complete details on these Ford Custom Accessories.

C CLASS-EXCLUSIVE POWERSCOPE[™] TRAILER TOW MIRRORS adjust, fold and telescope almost 3 inches at the touch of a switch; this option includes integrated clearance lights and turn signals, plus heated glass with manually adjustable spotter mirrors.

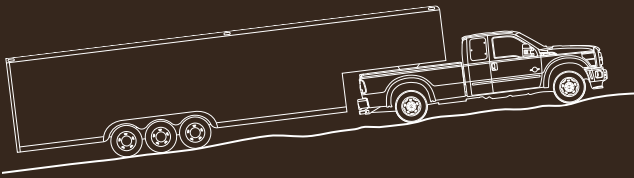

Ford has everything you need to make towing heavy loads easy including smart features like **HILL START ASSIST**, which helps prevent you from rolling back on a grade by momentarily maintaining brake pressure until the engine delivers enough torque to move the truck up the hill. Whether heading up an incline in Drive or in Reverse, you're covered.



CLASS-EXCLUSIVE IN-BED 7-PIN CONNECTOR, part of the optional 5th-Wheel/Gooseneck Trailer Tow Prep Package, makes connecting your trailer wiring quick and easy thanks to its convenient location.



Conventional trailer hookups are easy with the **REAR VIEW CAMERA** option. Just shift into reverse, and a full-color image from the tailgate-mounted camera is displayed in your rearview mirror or on the available Navigation System's 6.5-in. screen (shown).



The available factory-integrated **TRAILER BRAKE CONTROLLER** uses braking input, vehicle speed and ABS logic to balance the performance of the truck brakes and electric trailer brakes. Compatible with certain electric and electric-over-hydraulic trailer brake systems.³

¹See your dealer for Limited Warranty details. ²Available with 8-ft. box only. ³Trailer brake controller verified to be compatible with electrically actuated drum brakes and certain electric-over-hydraulic brake systems. See your Ford Dealer for details.

2011 SUPER DUTY[®]

ford.com





LARIAT Crew Cab in Adobe Leather trim with available equipment

Takes **COMFORT** and **CONTROL** to a whole **NEW LEVEL.**

Redesigned Interior With All-New LCD Productivity Screen.

The new 2011 Super Duty® combines smart design with high-tech features to help make your life easier, from the **REDESIGNED SEATS** with exclusive Ford active comfort contours and a standard lumbar support for the driver to the available factory-installed **REMOTE START**.

The available **LCD PRODUCTIVITY SCREEN** (below) displays engaging, easy-to-use menus to help you track fuel usage, explore unique truck applications and even make towing decisions. You can also use it to limit your truck's top speed with the available class-exclusive **MyKey®** owner controls feature. Steering wheel-mounted controls put it all comfortably within reach. And the steering column now **TILTS AND TELESCOPES** – standard on every 2011 Super Duty.

Fuel Econ. ■■ NW

Instant MPG 218 mi to E

30

18.6 AVG MPG

0

Hold OK to Reset

003195.7 mi

Compass ■■ NE

Press OK for Options

003195.7 mi

Tongue Jack Raised ?

Press OK to confirm

003195.7 mi

2011 SUPER DUTY®

ford.com



MOST EFFICIENT MOBILE OFFICE in its class.

Class-Leading Storage Solutions And Much More.

With its collection of available technologies, **BEST-IN-CLASS INTERIOR STORAGE** possibilities, including the **MOST LOCKABLE STORAGE** (up to 2.4 cu. ft.) and the most power access available in the class (up to 6 locations), Super Duty® is built to help you take care of business. A steadfast favorite of those determined to work regardless of the weather, the available **RAPID-HEAT SUPPLEMENTAL CAB HEATER**¹ helps raise the cabin temp so you and your crew can stay active even when it's downright frigid outside.

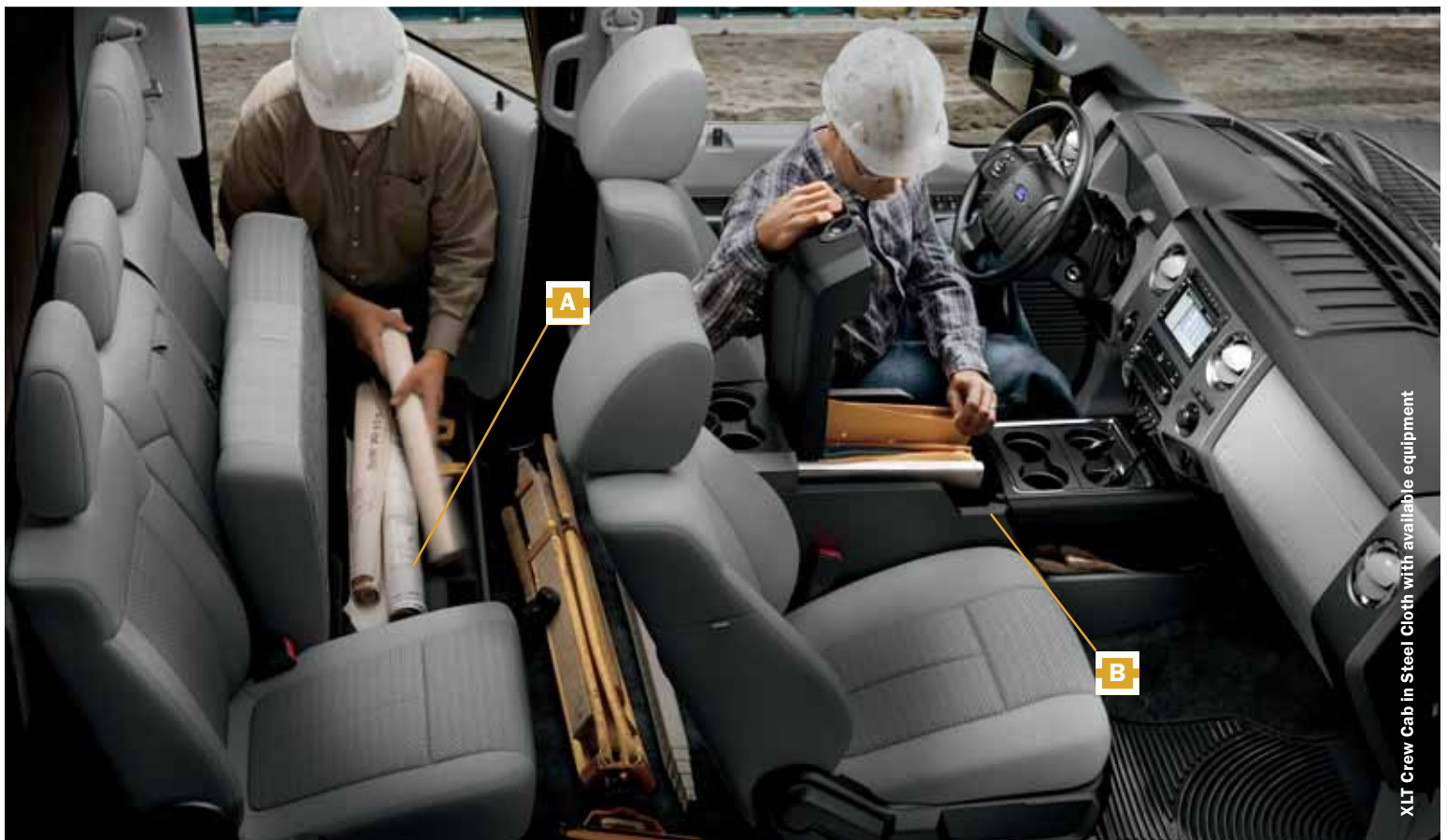

XLT Crew Cab in Steel Cloth with available equipment

A LOCKABLE UNDER-SEAT STORAGE includes a removable partition and a 12-volt powerpoint on the driver's side; included with the rear bench on XLT, LARIAT and KING RANCH® Crew Cab.



B BIG CENTER CONSOLE is a versatile option that provides lockable storage space you can configure in over 70 different ways – hang your files, stow your laptop, even charge your gadgets out of sight with one of its two 12-volt powerpoints.

FRONT LOCKABLE UNDER-SEAT STORAGE with a 12-volt powerpoint is included on the available 40/20/40 split front seat on XLT and LARIAT.



110-VOLT POWER INVERTER is conveniently located on the back of the available center console.



DUAL-ZONE ELECTRONIC AUTOMATIC TEMPERATURE CONTROL, standard on LARIAT and KING RANCH, combines with the available **HEATED AND COOLED FRONT SEATS** to help increase your comfort in all climates.

¹Optional on models equipped with the 6.7L Power Stroke® V8 Turbo Diesel engine.

2011 SUPER DUTY®

ford.com



A DUAL ALTERNATORS WITH 357-AMP RATING are optional with the 6.7L Turbo Diesel engine; they provide 11.5% more peak amperage than the previous generation.

B COIL-SPRING FRONT SUSPENSION is part of a heavy-duty, independent Twin I-Beam setup on 4x2s and a rugged twin-coil monobeam setup on 4x4s.

C REVISED STEERING SYSTEM on F-250 and F-350 4x2s is symmetrical left to right for more precise response with better on-center steering and control.

D SOLID FRONT AXLE WITH MANUAL LOCKING HUBS is a tried-and-true 4x4 design that delivers excellent articulation, dynamic ground clearance and rugged reliability.

E DURABLE TRANSFER CASE SKID PLATE utilizes high-strength steel for better off-road protection with less weight; part of the optional FX4 OFF-ROAD Package.

F STANDARD 4-WHEEL ANTI-LOCK BRAKE SYSTEM (ABS) uses vented rotors and dual-piston calipers for consistent stops, even with the heaviest loads.

G RIDE AND HANDLING IMPROVEMENTS include optimized rear leaf springs and spring rates, plus adjustments to the internal valving in all pickup shock absorbers, offering a more refined ride experience with best-in-class towing and payload capability.



■ An available **ELECTRONIC-LOCKING REAR DIFFERENTIAL** uses a true mechanical dog-clutch mechanism to lock both rear axle shafts together so they turn at the same speed for maximum traction.



■ Monitor pitch angle, bank angle and wheel direction with the **CLASS-EXCLUSIVE OFF-ROAD DISPLAY** in the available LCD productivity screen.

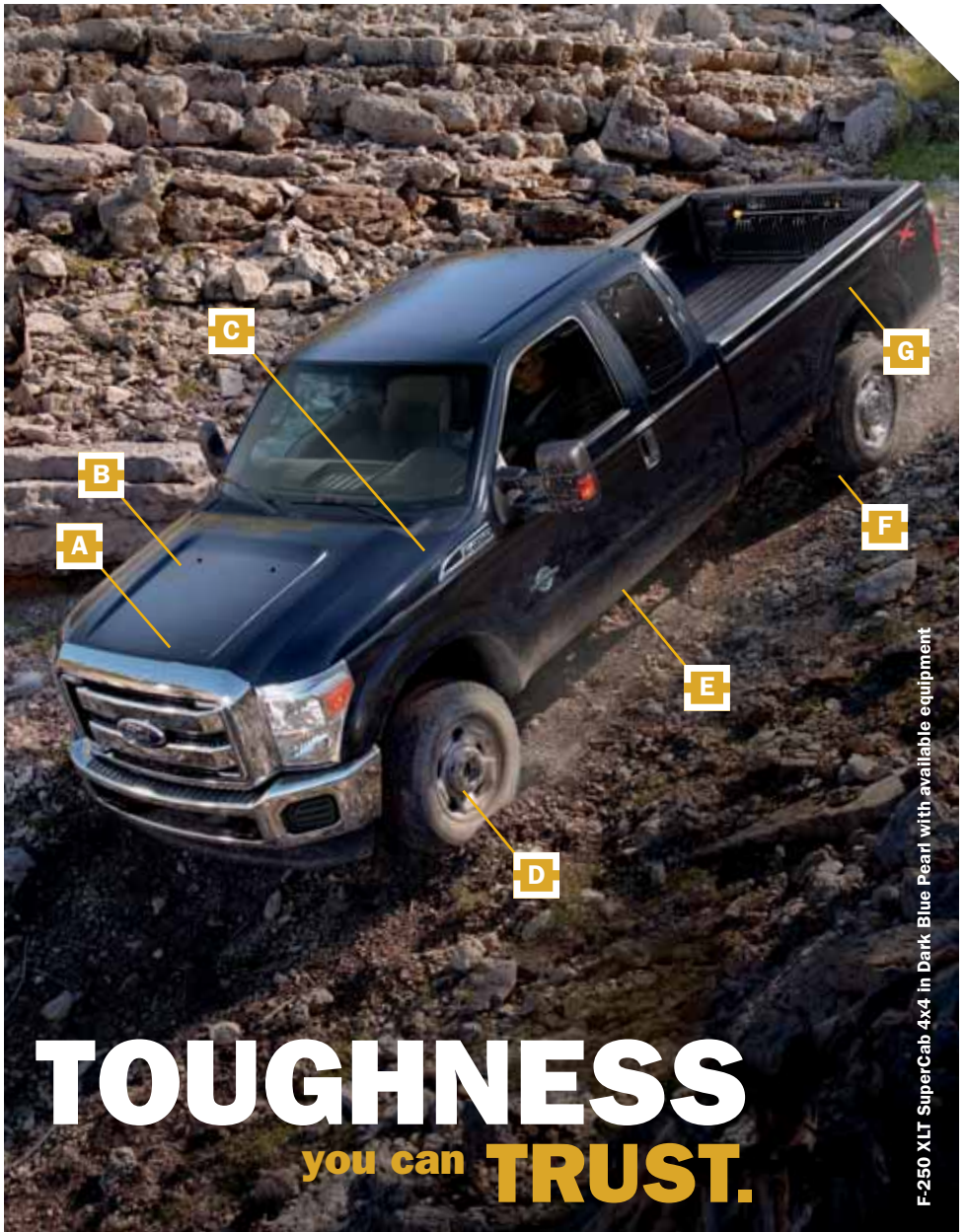

TOUGHNESS

you can **TRUST.**

F-250 XLT SuperCab 4x4 in Dark Blue Pearl with available equipment

Enhanced Off-Road Capability.

An indisputable fact: There are more F-Series trucks on the road with 250,000+ miles than any other brand. So you can rest assured the new 2011 Super Duty® is built on a solid foundation, one that's designed to meet most any challenge and conquer most any terrain. At the push of a button, available **HILL DESCENT CONTROL™¹** helps maintain the speed of the truck on steep declines. It allows you to concentrate on driving rather than modulating the brakes, increasing your off-road confidence.

¹SRW models with optional FX4 OFF-ROAD Package only.

2011 SUPER DUTY®

ford.com



STRENGTH

you can **COUNT ON.**



F-250 XL Regular Cab 4x2 in Oxford White with available equipment

A

B

BEST-IN-CLASS MAX. PAYLOAD: 7,070 LBS.

Hardworking people need a hardworking truck. The new 2011 Super Duty® gives its all to every job with **BEST-IN-CLASS PAYLOAD** capability of up to 7,070 lbs.¹ plus equipment to help you load, access and manage that payload. When your reputation's on the line, your truck's got to deliver.

A CLASS-EXCLUSIVE TAILGATE STEP option stows right in the tailgate; includes flip-up grab bar and skid-resistant step.

B REMOVABLE TAILGATE includes a key lock. Tailgate assist with torsion spring enables easy operation.

TOUGHBED® FACTORY-INSTALLED SPRAY-IN BEDLINER (below) is an optional industrial-grade synthetic lining applied directly to the bed for durable, long-lasting protection.

FORD WORK SOLUTIONS™ CABLE LOCK by Master Lock® (below) makes it easy to secure your gear. The optional 10-ft. vinyl-coated, retractable, braided-steel cable spools out of a rugged case mounted right in your cargo box.

An optional **CLASS-EXCLUSIVE STOWABLE BED EXTENDER** lets you haul with the tailgate down or corral smaller loads with it up. When not in use, the extender stows conveniently to the sides – out of your way.



¹When properly equipped. F-350 DRW Regular Cab 4x2.

2011 SUPER DUTY®

ford.com





XLT In Adobe Cloth with Ford Work Solutions In-Dash Computer, available wireless printer and other available equipment

TECHNOLOGIES that give your team the ADVANTAGE.



Cutting-Edge Mobile Office.

Only the toughest name in trucks could assemble this all-star lineup of **SMART TOOLS** for your tough jobs.

At the heart of it all is the available **INTERNET-CAPABLE IN-DASH COMPUTER** with Garmin® navigation, hands-free calling and a convenient touch screen with wireless keyboard. From spreadsheets to searching the web, it helps tackle your workload and ease your day.¹

Take advantage of the available **CREW CHIEF™** fleet management system from Microlise™ to track your vehicles and keep them in shape with key diagnostic/informational maintenance reports.² This beneficial system can be accessed from the Ford Work Solutions™ In-Dash Computer, or any computer connected to the Internet.

Like to save time and money on the job? The available **TOOL LINK™** system can help. Using Radio Frequency ID (RFID) technology¹ from DeWALT,[®] Tool Link helps track your tools before and after each job.³



SIRIUS® SATELLITE RADIO is an available introductory 6-month subscription to over 130 channels including 100% commercial-free music, plus the best in sports, news, talk and entertainment, 24/7, coast-to-coast. New for 2011, you can call to add The Best of XM channels at no charge.⁴



NAVIGATION SYSTEM features a vibrant 6.5-in. LCD touch screen with colorful maps that you can zoom and scroll, paired with the Premium Sound System including in-dash single-CD player. New for 2011, **HD RADIO™ TECHNOLOGY** helps it deliver your favorite AM and FM channels, plus new local FM channels, in crystal-clear digital sound. This available system provides nearly 10 gigs of photo and music storage space. It also includes an introductory 6-month subscription to **SIRIUS TRAFFIC™** and **SIRIUS TRAVEL LINK™⁴** which provides fuel prices, weather reports, movie listings, sports scores and more.



VOICE-ACTIVATED FORD SYNC® is an award-winning, available system that works with your paired Bluetooth®-enabled mobile phone and your digital media player. It provides hands-free calling, plays music, and delivers Vehicle Health Reports and 911 Assist.[™] With the touch of a button and voice commands. SYNC with **TRAFFIC, DIRECTIONS AND INFORMATION** services provides turn-by-turn directions, personalized traffic alerts and more.⁵ SyncMyRide.com has the latest details. SYNC. Say the word.

Ford Work Solutions include Ford Licensed Accessories. See dealer for limited warranty details.

¹Available on XL and XLT models only. Some features are unavailable while driving. Not available with SYNC or SIRIUS Satellite Radio. See your dealer for details.

²Service fee required. ³Tool Link system cannot read tagged items stored in metal tool boxes. ⁴Traffic updates available in select markets. Some features are unavailable while driving. Service available in the 48 contiguous states and D.C. SIRIUS, XM and all related marks and logos are trademarks of SIRIUS XM Radio Inc. Subscriptions governed by SIRIUS Terms and Conditions available at sirius.com, and sold separately after complimentary period. ⁵Driving while distracted can result in loss of vehicle control. Only use mobile phones and other devices, even with voice commands, when it is safe to do so.

Traffic alerts and turn-by-turn directions available in select markets. Standard text messaging and data rates apply.

2011 SUPER DUTY®

ford.com



STANDARD FEATURES

MECHANICAL

90,000-mile tune-up interval ¹ (gas engines)
Battery saver
Brakes – Vacuum-boost (SRW gas and F-250 SRW diesel)
Brakes – Hydro-boost (F-350 SRW diesel and DRW)
Conventional spare tire/wheel/jack with underframe carrier (crank-down type)
Engine-only traction control (EOTC) (DRW only)
Fail-Safe Engine Cooling System (gas engines)
Fuel tank – 26-gallon capacity (F-250/F-350 137-in., 142-in. and 156-in. WB with diesel engine)
Fuel tank – 35-gallon capacity (gas engine only)
Fuel tank – 37.5-gallon capacity (F-250/F-350 158-in. and 172-in. WB with diesel engine, and F-450)
Power steering
Quick-release tailgate with tailgate assist
Stabilizer bar – Front
Stabilizer bar – Rear (DRW only)
Stainless steel exhaust system (major components)
Stationary elevated idle control (SEIC) ²
Steering damper
Styleside box
Tire Pressure Monitoring System (SRW only; excludes spare)
Trailer hitch receiver – 12.5K (2-in.) Built Ford Tough® (SRW)
Trailer hitch receiver – 14K (2.5-in.) Built Ford Tough ³ (SRW diesel with 156-in., 158-in. and 172-in. WB only)
Trailer hitch receiver – 15K (2.5-in.) Built Ford Tough ³ (F-350 DRW 137-in. and 158-in. WB only)
Trailer hitch receiver – 17.5K (2.5-in.) Built Ford Tough ³ (F-350 DRW 172-in. WB and F-450 only)
Trailer sway control

INTERIOR

Assist and ride handles
Coat hooks – 1 (Regular Cab); 2 in rear of cab (SuperCab and Crew Cab)
Dome light (front and rear with Crew Cab)
Flip-open rear quarter windows (SuperCab)
Overhead console with garage door opener storage and sunglasses storage (SuperCab and Crew Cab)
Powerpoints on instrument panel (2)
Tilt/telescoping steering column

HD Radio is a proprietary trademark of iBiquity Digital Corp.

Microsoft is a registered trademark of Microsoft Corporation.

The Bluetooth word mark is a trademark of the Bluetooth SIG, Inc.

Windows is a registered trademark of Microsoft Corporation.

DeWALT is a registered trademark of The Black & Decker Corporation.

Garmin is a registered trademark of Garmin Ltd.

Master Lock is a registered trademark of Master Lock Company LLC.

Microlise is a registered trademark of Microlise Limited.

Rancho is a registered trademark of Tenneco Automotive Operating Company Inc.

¹Under normal driving conditions with routine fluid and filter changes. ²Final-stage manufacturer must supply control switches. ³Vehicles with standard 2.5-in. receiver hitch are also equipped with a 2.0-in. reducer sleeve. ⁴Always wear your safety belt and always deactivate the passenger airbag when using a rear-facing child-safety seat in Regular Cab and SuperCab models. Always wear your safety belt and always secure children in the rear seat in Crew Cab models.

EXTERIOR

"3-blink" lane change signal
7-/4-pin trailer tow connector and trailer brake wiring kit (in-cab; no controller)
Cargo box rail and tailgate top moldings
Cargo box stake pockets
Cargo tie-down hooks (4 in 6¾-ft. box; 6 in 8-ft. box)
Dual-beam jewel-effect headlamps
Front and rear step bumpers
Integrated cargo box lamp with center high-mounted stop lamp
Partitionable and stackable cargo box
Roof clearance lamps (DRW)
Solar-tinted glass
Tow hooks (2 in front)
Underhood service lamp
Windshield wipers – Intermittent

SAFETY & SECURITY

4-wheel power disc brakes with Anti-Lock Brake System (ABS)
Airbags ⁴ – Driver and right-front-passenger front
Airbags ⁴ – Front-seat side
Airbags ⁴ – Safety Canopy® System with roll-fold side-curtain airbags
AdvanceTrac® with RSC® (Roll Stability Control™) (SRW only)
Belt-Minder® front safety belt reminder
Brake/shift interlock
Child-safety-seat top tether anchors (Regular Cab front passenger and all rear-seat positions)
Fuel pump inertia shutoff switch
Headlamps-on, key-in-ignition and door ajar alert chimes
Height-adjustable safety belts at front-outboard positions
Locking tailgate
Passenger airbag deactivation switch (Regular Cab, SuperCab)
Safety belt energy-management retractors at front-outboard positions
SecuriLock® Passive Anti-Theft System
Side-intrusion door beams
SOS Post-Crash Alert System™
Spare tire/wheel lock

New Vehicle Limited Warranty. We want your Ford F-Series Super Duty® ownership experience to be the best it can be. So under this warranty, your new vehicle comes with 3-year/36,000-mile bumper-to-bumper coverage, 5-year/60,000-mile Powertrain Warranty coverage, 5-year/50,000-mile safety restraint coverage, and 5-year/unlimited-mile corrosion (perforation) coverage – all with no deductible. The Power Stroke diesel engine gets 5-year/100,000-mile Warranty Coverage. Please ask your Ford Dealer for a copy of this limited warranty.

Roadside Assistance. Covers your vehicle for 5 years or 60,000 miles, so you have the security of knowing that help may be only a phone call away should you run out of fuel, lock yourself out of the vehicle, or need towing. Your Ford Dealer can provide complete details on all of these advantages.

Ford Credit. Get the ride you want. Whether you plan to lease or finance, you'll find the choices that are right for you at Ford Credit. Ask your Ford Dealer for details or check us out at fordcredit.com.

Ford Extended Service Plan. For a purchase or lease, the Ford Extended Service Plan (ESP) gives you "Peace-of-Mind" protection designed to cover key vehicle components and protect you from the cost of unexpected repairs. Ask your dealer for a Ford ESP, the only service contract backed exclusively by Ford and honored at all Ford dealerships.

Insurance Services. Get Ford Motor Company quality in your auto insurance. Our program offers industry-leading benefits and competitive rates. Call 1-877-367-3847, or visit us at fordvip.com for a no-obligation quote. Insurance offered by American Road Services Company (in CA, American Road Insurance Agency), a licensed agency and subsidiary of Ford Motor Company.

Comparisons based on 2011 competitive models (class is Full-Size Pickups over 8,500 lbs. GVWR), publicly available information and Ford certification data at time of release. Some features discussed may be optional. Vehicles throughout this PDF are shown with optional and aftermarket equipment. Features shown may be offered only in combination with other options or subject to additional ordering requirements or limitations. Dimensions and capacity ratings shown may vary due to optional features and/or production variability. Following publication of the catalog, certain changes in standard equipment, options and the like, or product delays may have occurred which would not be included in these pages. Your Ford Dealer is the best source for up-to-date information. Ford Division reserves the right to change product specifications at any time without incurring obligations. Body manufacturers are responsible for compliance certification of the completed vehicle. The Ford New Vehicle Limited Warranty and any government certification made by Ford shall cover only the vehicle as manufactured by Ford and shall not extend to any addition, modification or change of or to the vehicle by the Ford Authorized Pool Account.

©2010 Ford Motor Company 11FSDJ2WEBPDF

2011 SUPER DUTY®

ford.com



STANDARD FEATURES



XL

Includes all standard features, plus:

MECHANICAL

6.2L SOHC 2-valve Gas V8 Flex Fuel E85-capable engine (n/a on F-450)

6.7L Power Stroke® V8 Turbo Diesel B20-capable engine (standard on F-450)

TorqShift® Heavy-Duty 6-speed SelectShift Automatic™ transmission

17-in. argent-painted steel wheels (F-250/F-350)

17-in. forged polished-aluminum wheels (F-450)

LT245/75R17 all-season BSW tires

Integrated trailer brake controller (DRW)

Manual 4-Wheel-Drive System with manual locking hubs (4x4 models only)

SEATING

40/20/40 split HD vinyl front seat with armrest, cupholders and storage

60/40 split flip-up rear seat (SuperCab only)

60/40 split flip-up/fold-down rear bench seat with outboard and center head restraints (Crew Cab only)

Lumbar support for driver's seat

INTERIOR

AM/FM stereo with digital clock and 2 speakers

Black urethane steering wheel

Black vinyl floor covering

Manual air conditioning

Manual day/night rearview mirror

Multifunction message center plus trip computer includes 3-button steering wheel switch, odometer, trip odometer, engine oil monitor, engine-hour meter, engine idle hour meter (6.2L Gas only), distance to empty, average fuel economy, warning messages, system check, language selection and Ice Blue™ lighting

Visors with passenger mirror

EXTERIOR

6-in. angular Black molded cab steps (DRW only)

Black bar-style grille

Black box top and tailgate moldings

Black door handles

Black-painted bumpers with grained top cover

Manually telescoping trailer tow mirrors with 2-way fold and manual glass



XLT

Includes all XL features, plus:

MECHANICAL

17-in. 5-spoke cast-aluminum wheels (SRW)

Integrated trailer brake controller (SRW)

SEATING

40/20/40 split front seat with center under-seat lockable storage with 12-volt powerpoint and center armrest with cupholders and storage

60/40 split flip-up/fold-down rear bench seat with bag hooks, dual integrated cupholders and tray, outboard head restraints, center head restraint and lockable under-seat partitioned storage with 12-volt powerpoint (Crew Cab only)

INTERIOR

Accessory delay for power features

AM/FM stereo/single-CD player with MP3 capability, digital clock and 4 speakers

Auxiliary audio input jack

Cruise control

Color-coordinated floor covering (carpet)

Color-coordinated floor mats (carpet)

MyKey® owner controls feature

Power door locks

Power windows with one-touch-down driver's side window feature

Visors with covered driver and passenger mirrors

EXTERIOR

Chrome bar-style grille

Chrome bumpers with grained top cover

Manually telescoping trailer tow mirrors with 2-way fold, power/heated glass, heated manual spotter mirrors, and integrated clearance lamps and turn signals

Perimeter anti-theft alarm

Privacy glass (rear doors and rear window)

Remote Keyless Entry System with 2 integrated keyhead transmitter remotes



LARIAT

Includes all XLT features, plus:

MECHANICAL

Electronic shift-on-the-fly (ESOF) 4-Wheel-Drive System with auto/manual locking hubs (4x4 models only)

17-in. forged polished-aluminum wheels

(F-350 DRW)

18-in. bright-machined cast-aluminum wheels (SRW)

LT275/65R18 all-season BSW tires (SRW)

Reverse Vehicle Aid Sensor

SEATING

40/console/40 leather-trimmed front bucket seats and flow-through center console with lockable storage, two 12-volt powerpoints and a 110-volt power inverter

Power 10-way driver and front-passenger seats

INTERIOR

Air conditioning with dual-zone electronic automatic temperature control

Auto-dimming rearview mirror

Color-coordinated leather-wrapped steering wheel with secondary audio controls

Driver-configurable enhanced information center with LCD productivity screen includes gauge setup, compass, trip computer, fuel economy and towing/off-road applications, SelectShift controls, Ice Blue lighting, halo lighting, daytime illumination and 5-button steering wheel-mounted switch

Ford SYNC® voice-activated, in-vehicle connectivity system

Power-adjustable pedals

Premium Sound System includes AM/FM stereo/single-CD player with MP3 capability, digital clock and 8 speakers with subwoofer

SIRIUS Satellite Radio with 6-month introductory subscription

Visors with illuminated driver and passenger mirrors

Woodgrain-style instrument panel accents

EXTERIOR

5-in. chrome tubular cab steps (DRW)

Autolamp with rainlamp feature

Body-color door handles

Fog lamps

PowerScope™ power-telescoping/-folding trailer tow mirrors with power/heated glass, heated manual spotter mirrors, and integrated clearance lamps and turn signal indicators

Power-sliding rear window with privacy glass

SecuriCode™ keyless entry keypad



KING RANCH®

Includes all LARIAT features, plus:

SEATING

Chaparral leather-trimmed front seats with flow-through center console

Easy entry/exit driver's seat memory feature

Heated/cooled driver and front-passenger seats

INTERIOR

Chaparral leather-wrapped steering wheel with secondary audio controls

Color-coordinated floor mats with King Ranch logo (carpet)

Memory Group includes memory feature on power trailer tow mirrors, power 10-way driver's seat, and adjustable pedals

Rear view camera

Remote Start System

Unique woodgrain-style instrument panel accents

Universal garage door opener

EXTERIOR

Accent-color box top and tailgate moldings

Accent-color monochromatic bumpers

Accent-color wheel-lip moldings (SRW)

Body-color bodyside moldings (SRW)

Body-color grille surround with chrome insert

Illuminated accent-color cab steps with bright insert

PowerScope power-telescoping/-folding trailer tow mirrors with memory, power/heated glass, heated manual spotter mirrors, integrated clearance lamps and turn signal indicators with body-color mirror caps

Two-tone lower-accent paint

XL



Argent-Painted Steel Wheels
17-in. Standard on F-250/F-350 SRW
18-in. Optional on F-350 SRW



17-in. Argent-Painted Steel Wheels
Standard on F-350 DRW



17-in. Argent-Painted Steel Wheels
with Stainless Steel Covers
Optional on F-350 DRW



17-in. Forged Polished-Aluminum
Wheels
Standard on F-450 DRW



17-in. 5-Spoke Cast-Aluminum Wheels
Optional on F-250/F-350 SRW



17-in. Argent-Painted Steel Wheels
with Bright Center Cap
included on F-250/F-350
with XL Value Package



XL Regular Cab in Steel HD Vinyl with available equipment



F-250 XL Regular Cab 4x2 in Oxford White with available equipment

2011 SUPER DUTY®

ford.com



XL OPTIONAL FEATURES

MECHANICAL

- 6.7L Power Stroke® V8 Turbo Diesel B20-capable engine (standard on F-450)
- Electronic shift-on-the-fly (ESOF) 4-Wheel-Drive System with auto/manual locking hubs (4x4 models only)
- 17-in. 5-spoke cast-aluminum wheels – 4 (F-250/F-350 SRW)
- 18-in. argent-painted steel wheels – 4 (F-350 SRW)
- Stainless steel wheel covers (require 17-in. argent-painted steel wheels)¹
- LT245/75R17 all-terrain BSW tires – 5
- LT265/70R17 all-terrain OWL tires – 4 (F-250/F-350 SRW)
- LT275/65R18 all-season BSW tires – 5 (F-350 SRW)
- LT275/70R18 all-terrain BSW tires – 4 (F-350 SRW)
- 5th-Wheel/Gooseneck Trailer Tow Prep Package includes 1 under-bed-frame crossmember, 5 pickup bed 5th-wheel/gooseneck attachment points and close-out plugs, and an integrated 7-pin connector on the driver's side pickup bed wall
- 5th-wheel hitch kit (requires 8-ft. box)²
- Gooseneck hitch kit (requires 8-ft. box)²
- Alternator – Single, extra-heavy-duty 200-amp (diesel engine only)
- Alternators – Dual, 357-amp total (diesel engine only)
- Engine block heater (standard in 15 cold-weather states)
- Integrated trailer brake controller (standard on F-350 DRW/F-450)
- Operator Commanded Regeneration (diesel engine only)
- Power takeoff (PTO) provision allows transmission-mounted live drive and stationary modes (diesel engine only)
- Rear axle – Electronic-locking (F-250/F-350 SRW only)
- Rear axle – Higher-ratio (gas engine only)
- Rear axle – Limited-slip (F-350 DRW only; standard on F-450)

SEATING

- 40/mini-console/40 front bucket seats (HD vinyl or cloth)

INTERIOR

- AM/FM stereo/single-CD player with MP3 capability, digital clock and 4 speakers³ (Fleet only on F-250/F-350)
- Auxiliary audio input jack (requires CD)
- Ford SYNC® voice-activated, in-vehicle connectivity system (requires XL Value Package and steering wheel-mounted audio controls)
- Rapid-heat supplemental cab heater (requires diesel engine and alternator upgrade)
- Remote Start System (requires Power Equipment Group)
- Steering wheel-mounted audio controls (requires SYNC)
- Upfitter switches located on instrument panel (4)

EXTERIOR

- 6-in. angular Black molded cab steps (standard on DRW)
- Bed mat (restrictions apply)
- Exterior back-up alarm
- Manually telescoping trailer tow mirrors with 2-way fold, power/heated glass, heated manual spotter mirrors, and integrated clearance lamps and turn signals⁴
- Pickup box delete (F-250/F-350 only; requires 8-ft. box; n/a with 20-in. wheels or FX4 OFF-ROAD Package)
- Roll-up tonneau cover¹
- Roof clearance lamps (standard on DRW)
- Splash guards/mud flaps (front and rear on SRW; rear only on DRW)
- Tailgate step includes step, tailgate assist and grab bar
- ToughBed® spray-in bedliner includes tailgate guard and black bed bolts

FORD WORK SOLUTIONS™

- In-dash Windows® CE computer with touch screen navigation and hands-free calling (restrictions apply)¹
- Cable Lock by Master Lock®¹
- Crew Chief™ – Fleet tracking system (n/a with in-dash computer)¹
- Tool Link™ (requires in-dash computer; restrictions apply)¹

PACKAGES

- XL Value Package** includes AM/FM stereo/single-CD player with MP3 capability, digital clock, 4 speakers, cruise control, chrome bumpers and MyKey® owner controls feature

See page 24 for content of the following packages:

- 10,000-lb. GVWR Package** (F-350 SRW) **Heavy-Service Front Suspension Package**
- Camper Package** (restrictions apply) **Power Equipment Group**
- FX4 OFF-ROAD Package** **Snow Plow Prep Package** (4x4 only; restrictions apply)

¹Ford Licensed Accessory. See your dealer for limited warranty details. ²Requires 5th-Wheel/Gooseneck Trailer Tow Prep Package. See your dealer for details. ³Included as part of XL Value Package. ⁴Included as part of Power Equipment Group.

Colors shown are representative only. See your dealer for actual paint/trim options. Fabric patterns and colors are subject to change or substitution without notice.

EXTERIOR



INTERIOR



EXTERIOR COLORS

EXTERIOR COLORS	INTERIOR COLORS
Oxford White	■ ●
Vermillion Red	■ ●
Dark Blue Pearl Metallic	■ ●
Forest Green Metallic	■ ●
Ingot Silver Metallic	■ ●
Sterling Gray Metallic	■ ●
Tuxedo Black Metallic	■ ●
Pale Adobe Metallic	■ ●

INTERIORS: ■ Steel HD Vinyl ● Steel Cloth

SEATING, BOX AND CAB CONFIGURATIONS

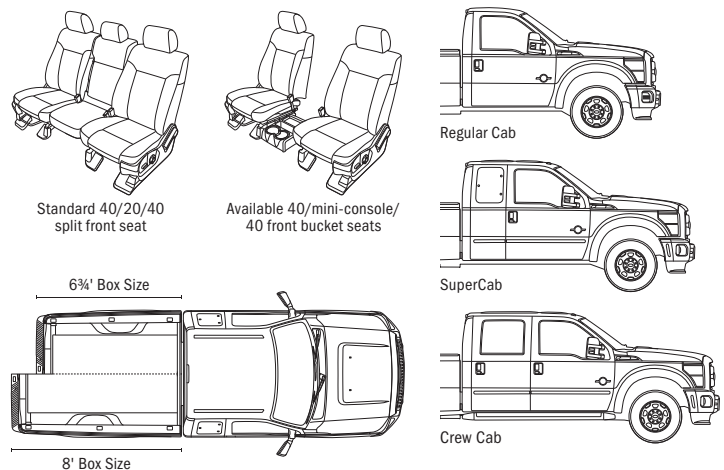

XLT



17-in. 5-Spoke Cast-Aluminum Wheels
Standard on F-250/F-350 SRW



17-in. Argent-Painted Steel Wheels
Standard on F-350 DRW



17-in. Argent-Painted Steel Wheels
with Stainless Steel Covers
Optional on F-350 DRW



17-in. Forged Polished-Aluminum Wheels
Standard on F-450 DRW/Optional on F-350 DRW



18-in. Cast-Aluminum Wheels
Optional on F-250/F-350 SRW



20-in. Premium Cast-Aluminum Wheels
Optional on F-250/F-350 SRW



XLT Crew Cab in Steel Cloth with flow-through center console and available equipment



F-250 XLT SuperCab 4x4 in Tuxedo Black with available equipment

2011 SUPER DUTY®

ford.com



XLT OPTIONAL FEATURES

MECHANICAL

- 6.7L Power Stroke® V8 Turbo Diesel B20-capable engine (standard on F-450)
- Electronic shift-on-the-fly (ESOF) 4-Wheel-Drive System with auto/manual locking hubs (4x4 models only)
- 17-in. forged polished-aluminum wheels — 4 (F-350 DRW)
- 18-in. cast-aluminum wheels — 4 (F-250/F-350 SRW)
- Stainless steel wheel covers (require 17-in. argent-painted steel DRW wheels)¹
- 20-in. premium cast-aluminum wheels — 4 (F-250/F-350 SRW 4x4 diesel engine only; SuperCab and Crew Cab only)
- LT245/75R17 all-terrain BSW tires — 5 (F-350 DRW/F-450)
- LT245/75R17 all-terrain OWL tires — 4 (F-350 DRW/F-450)
- LT265/70R17 all-terrain OWL tires — 4 (F-250/F-350 SRW)
- LT275/65R18 all-season BSW tires — 5 (F-250/F-350 SRW)
- LT275/70R18 all-terrain BSW tires — 4 (F-250/F-350 SRW 4x4)
- LT275/70R18 all-terrain OWL tires — 4 (F-250/F-350 SRW 4x4)
- LT275/65R20 all-terrain OWL tires — 4 (F-250/F-350 SRW 4x4; SuperCab and Crew Cab only; diesel engine only)
- 5th-Wheel/Gooseneck Trailer Tow Prep Package includes 1 under-bed-frame crossmember, 5 pickup bed 5th-wheel/gooseneck attachment points and close-out plugs, and an integrated 7-pin connector on the driver-side pickup bed wall (n/a with stowable bed extender)
- 5th-wheel hitch kit (requires 8-ft. box)²
- Gooseneck hitch kit (requires 8-ft. box)²
- Alternator — Single, extra-heavy-duty 200-amp (diesel engine only)
- Alternators — Dual, 357-amp total (diesel engine only)
- Engine block heater (standard in 15 cold-weather states)
- Operator Commanded Regeneration (diesel engine only; n/a with XLT Premium Package)
- Power takeoff (PTO) provision allows transmission-mounted live drive and stationary modes (diesel engine only)
- Rear axle — Electronic-locking (F-250/F-350 SRW only)
- Rear axle — Higher-ratio (gas engine only)
- Rear axle — Limited-slip (F-350 DRW; standard on F-450)
- Reverse Vehicle Aid Sensor (n/a with pickup box delete)

SEATING

- 40/console/40 front bucket seats and flow-through console with lockable storage, two 12-volt powerpoints and a 110-volt power inverter (SuperCab and Crew Cab only)
- Power 6-way driver's seat (requires 40/console/40 front bucket seats)

INTERIOR

- Black all-weather floor mats (deletes carpeted floor mats)
- Ford SYNC® voice-activated, in-vehicle connectivity system (requires XLT Interior Package and steering wheel-mounted audio controls)
- Rapid-heat supplemental cab heater (requires diesel engine and alternator upgrade)
- Rear view camera (requires XLT Interior Package)
- Remote Start System
- SIRIUS Satellite Radio with 6-month introductory subscription
- Steering wheel-mounted audio controls (requires SYNC)
- Upfitter switches located on instrument panel (4)

EXTERIOR

- Bed mat (restrictions apply)
- Body-color bodyside moldings (SRW only)
- Cab steps — 6-in. angular Black molded (standard on DRW)
- Cab steps — 5-in. chrome tubular (SuperCab and Crew Cab only)
- Exterior back-up alarm
- Manual-sliding rear window with privacy glass (Regular Cab only)
- Pickup box delete (F-250/F-350 only; requires 8-ft. box; n/a with 20-in. wheels or FX4 OFF-ROAD Package)
- PowerScope™ power-telescoping/-folding trailer tow mirrors with power/heated glass, heated manual spotter mirrors, and integrated clearance lamps and turn signals
- Power-sliding rear window with privacy glass (SuperCab and Crew Cab only)
- Roll-up tonneau cover¹
- Roof clearance lamps (standard on DRW)
- Splash guards/mud flaps (front and rear on SRW; rear only on DRW)
- Stowable bed extender (F-250/F-350 SRW only)
- Tailgate step includes step, tailgate assist and grab bar
- ToughBed® spray-in bedliner includes tailgate guard and black bed bolts

FORD WORK SOLUTIONS™

See XL model page for content.

PACKAGES

See page 24 for content of the following packages:

- | | |
|--|---|
| XLT Appearance Package | XLT Interior Package |
| XLT Premium Package | |
| 10,000-lb. GVWR Package (F-350 SRW) | FX4 OFF-ROAD Package |
| Camper Package (restrictions apply) | Heavy-Service Front Suspension Package |
| Chrome Package | Snow Plow Prep Package |

¹Ford Licensed Accessory. See your dealer for limited warranty details. ²Requires 5th-Wheel/Gooseneck Trailer Tow Prep Package. See your dealer for details.

EXTERIOR



INTERIOR



EXTERIOR COLORS

EXTERIOR COLORS	INTERIOR COLORS
Oxford White	● ●
Vermillion Red	● ●
Dark Blue Pearl Metallic	● ●
Forest Green Metallic	● ●
Ingot Silver Metallic	● ●
Sterling Gray Metallic	● ●
Tuxedo Black Metallic	● ●
Royal Red Metallic	● ●
Golden Bronze Metallic	● ●
Pale Adobe Metallic	● ●

INTERIORS: ● Adobe Cloth ● Steel Cloth

SEATING, BOX AND CAB CONFIGURATIONS

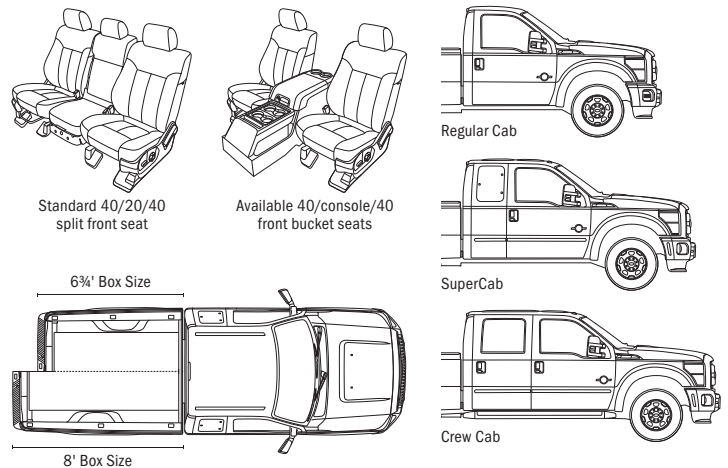

Colors shown are representative only. See your dealer for actual paint/trim options. Fabric patterns and colors are subject to change or substitution without notice.

LARIAT



F-450 in White Platinum Tri-coat/Pale Adobe Two-Tone with available equipment



17-in. Forged Polished-Aluminum Wheels
Standard on F-350 DRW/F-450



18-in. Bright-Machined
Cast-Aluminum Wheels
Standard on F-250/F-350 SRW



20-in. Premium Cast-Aluminum Wheels
Optional on F-250/F-350 SRW



Crew Cab in Black Leather trim with available equipment

2011 SUPER DUTY®

ford.com



LARIAT OPTIONAL FEATURES

MECHANICAL

6.7L Power Stroke® V8 Turbo Diesel B20-capable engine (standard on F-450)
 20-in. premium cast-aluminum wheels – 4 (F-250/F-350 SRW 4x4 diesel engine only)
 LT245/75R17 all-terrain BSW tires – 5 (F-350 DRW/F-450)
 LT245/75R17 all-terrain OWL tires – 4 (F-350 DRW/F-450)
 LT275/70R18 all-terrain BSW tires – 4 (F-250/F-350 SRW 4x4)
 LT275/70R18 all-terrain OWL tires – 4 (F-250/F-350 SRW 4x4)
 LT275/65R20 all-terrain OWL tires – 4 (F-250/F-350 SRW 4x4)
 5th-Wheel/Gooseneck Trailer Tow Prep Package includes 1 under-bed-frame crossmember, 5 pickup bed 5th-wheel/gooseneck attachment points and close-out plugs, and an integrated 7-pin connector on the driver's side pickup bed wall (n/a with stowable bed extender)
 5th-wheel hitch kit (requires 8-ft. box)¹
 Gooseneck hitch kit (requires 8-ft. box)¹
 Alternator – Single, extra-heavy-duty 200-amp (diesel engine only)
 Alternators – Dual, 357-amp total (diesel engine only)
 Engine block heater (standard in 15 cold-weather states)
 Power takeoff (PTO) provision allows transmission-mounted live drive and stationary modes (diesel engine only)
 Rear axle – Electronic-locking (F-250/F-350 SRW only)
 Rear axle – Higher-ratio (gas engine only)
 Rear axle – Limited-slip (F-350 DRW; standard on F-450)

SEATING

40/20/40 split front seats, center under-seat lockable storage with 12-volt powerpoint, and center armrest with cupholders and storage
 Heated/cooled driver and front-passenger seats (requires LARIAT Interior Package or LARIAT Ultimate Package)

INTERIOR

Black all-weather floor mats (deletes carpeted floor mats)
 Navigation System with Premium Sound System includes HD Radio™ technology, AM/FM stereo/single-CD player with MP3 capability, USB port, in-dash touch screen, voice-activated controls, SIRIUS Travel Link capability, digital clock and 8 speakers with subwoofer (requires rear view camera)
 Rapid-heat supplemental cab heater (requires diesel engine and alternator upgrade)
 Rear view camera
 Remote Start System
 Upfitter switches located on instrument panel (4)
 Universal garage door opener

EXTERIOR

5-in. chrome tubular cab steps (standard on DRW)
 Bed mat (restrictions apply)
 Body-color bodyside moldings (SRW only)
 Exterior back-up alarm
 Power-sliding moonroof (Crew Cab only)
 Power-sliding rear window with defrost
 Roll-up tonneau cover²
 Roof clearance lamps (standard on DRW)
 Skid plates on transfer case and fuel tank (included with FX4 OFF-ROAD Package)
 Splash guards/mud flaps (front and rear on SRW; rear only on DRW)
 Stowable bed extender (F-250/F-350 SRW only)
 Tailgate step includes step, tailgate assist and grab bar
 ToughBed® spray-in bedliner includes tailgate guard and black bed bolts
 Two-tone lower-accent paint (includes accent-color wheel-lip moldings on SRW)

FORD WORK SOLUTIONS™

Cable Lock by Master Lock®²
 Crew Chief™ – Fleet tracking system (n/a with in-dash computer)²

PACKAGES

LARIAT Interior Package includes rear view camera, easy entry/exit memory power heated/cooled driver's seat, power heated/cooled front-passenger seat, memory power trailer tow mirrors, memory power-adjustable pedals, and Remote Start System

LARIAT Ultimate Package includes easy entry/exit memory power heated/cooled driver's seat; power heated/cooled passenger seat; memory power trailer tow mirrors; memory power-adjustable pedals; moonroof; Navigation System; rear view camera; tailgate step; and Remote Start System (Crew Cab only; restrictions apply)

See page 24 for content of the following packages:

10,000-lb. GVWR Package (F-350 SRW) **FX4 OFF-ROAD Package**
Camper Package (restrictions apply) **Heavy-Service Front Suspension Package**
Chrome Package (other restrictions apply) **Snow Plow Prep Package** (4x4 only; restrictions apply)

¹Requires 5th-Wheel/Gooseneck Trailer Tow Prep Package.
²Ford Licensed Accessory. See your dealer for limited warranty details.

Colors shown are representative only. See your dealer for actual paint/trim options.
 Fabric patterns and colors are subject to change or substitution without notice.

EXTERIOR



Oxford White
 Pale Adobe or Sterling Gray Two-Tone optional



Dark Blue Pearl Metallic
 Sterling Gray Two-Tone optional



Ingot Silver Metallic
 Sterling Gray Two-Tone optional



Tuxedo Black Metallic
 Pale Adobe or Sterling Gray Two-Tone optional



Golden Bronze Metallic
 Pale Adobe Two-Tone optional

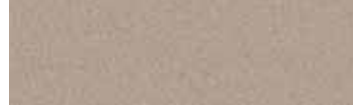

Pale Adobe Metallic (restrictions apply)

INTERIOR



Adobe Leather



Black Leather



Vermillion Red



Forest Green Metallic
 Pale Adobe or Sterling Gray Two-Tone optional



Sterling Gray Metallic



Royal Red Metallic
 Pale Adobe Two-Tone optional

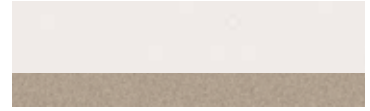

White Platinum Metallic Tri-Coat
 Pale Adobe Two-Tone optional

EXTERIOR COLORS	INTERIOR COLORS	TWO-TONE COLORS
Oxford White	■	▲ ▲
Vermillion Red	■	
Dark Blue Pearl Metallic	■	▲
Forest Green Metallic	■	▲ ▲
Ingot Silver Metallic	■	▲
Sterling Gray Metallic	■	
Tuxedo Black Metallic	■	▲ ▲
Royal Red Metallic	■	▲
Golden Bronze Metallic	■	▲
White Platinum Metallic Tri-coat	■	▲
Pale Adobe Metallic	■	

INTERIORS:
 ■ Adobe Leather ■ Black Leather
TWO-TONE COLORS:
 ▲ Pale Adobe Metallic ▲ Sterling Gray Metallic³
³Only available with Black Leather interior.

SEATING, BOX AND CAB CONFIGURATIONS



Standard 40/console/40 front bucket seats

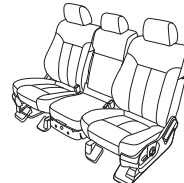

Available 40/20/40 split front seat

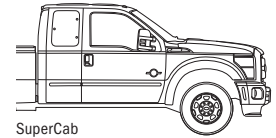

SuperCab

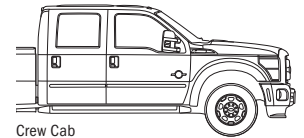

Crew Cab

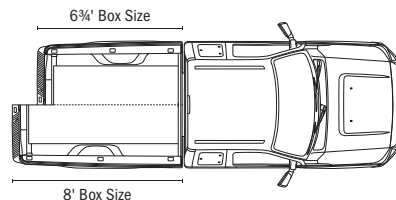

KING RANCH®



Crew Cab in Chaparral Leather trim with Black environment and available equipment



17-in. Forged Polished-Aluminum Wheels
Included on F-350 DRW/F-450



18-in. Bright-Machined Cast-Aluminum Wheels
Included on F-250/F-350 SRW



20-in. Premium Painted Cast-Aluminum Wheels
Optional on F-250/F-350 SRW



F-450 Crew Cab 4x4 in Royal Red with Chrome Package and available equipment

2011 SUPER DUTY®

ford.com



KING RANCH® OPTIONAL FEATURES

MECHANICAL

- 6.7L Power Stroke® V8 Turbo Diesel B20-capable engine (standard on F-450)
- 20-in. premium cast-aluminum wheels – 4 (F-250/F-350 SRW 4x4 diesel engine only)
- LT275/65R20 all-terrain OWL tires – 4 (F-250/F-350 SRW 4x4)
- 5th-Wheel/Gooseneck Trailer Tow Prep Package includes 1 under-bed-frame crossmember, 5 pickup bed 5th-wheel/gooseneck attachment points and close-out plugs, and an integrated 7-pin connector on the driver's side pickup bed wall (n/a with stowable bed extender)
- 5th-wheel hitch kit (requires 8-ft. box)¹
- Gooseneck hitch kit (requires 8-ft. box)¹
- Alternator – Single, extra-heavy-duty 200-amp (diesel engine only)
- Alternators – Dual, 357-amp total (diesel engine only)
- Engine block heater (standard in 15 cold-weather states)
- Power takeoff (PTO) provision allows transmission-mounted live drive and stationary modes (diesel engine only)
- Rear axle – Electronic-locking (F-250/F-350 SRW only)
- Rear axle – Higher-ratio (gas engine only)
- Rear axle – Limited-slip (F-350 DRW/F-450 only)

INTERIOR

- Black all-weather floor mats (deletes carpeted floor mats)
- Navigation System with Premium Sound System includes HD Radio™ technology, AM/FM stereo/single-CD player with MP3 capability, USB port, in-dash touch screen, voice-activated controls, SIRIUS Travel Link capability, digital clock and 8 speakers with subwoofer
- Rapid-heat supplemental cab heater (requires diesel engine and alternator upgrade)
- Upfitter switches located on instrument panel (4)

EXTERIOR

- Bed mat (restrictions apply)
- Exterior back-up alarm
- Power-sliding moonroof
- Power-sliding rear window with defrost
- Roll-up tonneau cover²
- Roof clearance lamps (standard on DRW)
- Splash guards/mud flaps (front and rear on SRW; rear only on DRW)
- Stowable bed extender (F-250/F-350 SRW only)
- Tailgate step includes step, tailgate assist and grab bar
- ToughBed® spray-in bedliner includes tailgate guard and black bed bolts

FORD WORK SOLUTIONS™

- Cable Lock by Master Lock®²
- Crew Chief™ – Fleet tracking system

PACKAGES

KING RANCH with Chrome Package includes chrome exhaust tip, chrome tow hooks, unique chrome mirror caps, chrome cargo tie-down hooks and 6-in. chrome angular step bars

See page 24 for content of the following packages:

- 10,000-lb. GVWR Package** (F-350 SRW)
- Camper Package** (restrictions apply)
- FX4 OFF-ROAD Package**
- Heavy-Service Front Suspension Package**
- Snow Plow Prep Package** (4x4 only; restrictions apply)

¹Requires 5th-Wheel/Gooseneck Trailer Tow Prep Package.

²Ford Licensed Accessory. See your dealer for limited warranty details.

Colors shown are representative only. See your dealer for actual paint/trim options. Fabric patterns and colors are subject to change or substitution without notice.

EXTERIOR

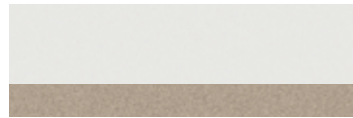

Oxford White
Pale Adobe Two-Tone



Forest Green Metallic
Pale Adobe Two-Tone



Tuxedo Black Metallic
Pale Adobe Two-Tone



Royal Red Metallic
Pale Adobe Two-Tone



Golden Bronze Metallic
Pale Adobe Two-Tone

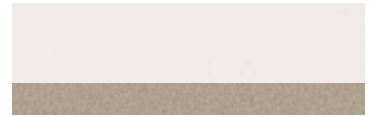

White Platinum Metallic Tri-coat
Pale Adobe Two-Tone

INTERIOR



Chaparral Leather

EXTERIOR COLORS	INTERIOR COLORS	TWO-TONE COLOR
Oxford White	■ ■	▲
Forest Green Metallic	■ ■	▲
Tuxedo Black Metallic	■ ■	▲
Royal Red Metallic	■ ■	▲
Golden Bronze Metallic	■ ■	▲
White Platinum Metallic Tri-coat	■ ■	▲

INTERIOR:

- Chaparral Leather with Adobe Environment
- Chaparral Leather with Black Environment

TWO-TONE COLOR: ▲ Pale Adobe Metallic

SEATING, BOX AND CAB CONFIGURATIONS



Standard 40/console/40 front bucket seats

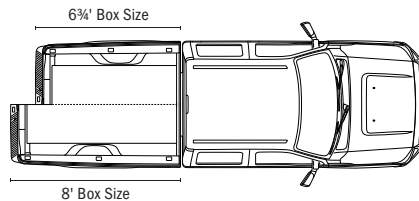

6 3/4' Box Size

8' Box Size

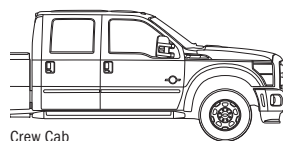

Crew Cab

PACKAGES

10,000-lb. GVWR Package (F-350 SRW)

Camper Package

Includes front springs upgrade (unless maximum springs have been computer-selected as included equipment), rear stabilizer bar (SRW), slide-in-camper certification and auxiliary rear springs on F-250 (restrictions apply)

Chrome Package

Includes chrome exhaust tip, chrome tow hooks, unique chrome mirror caps, chrome cargo tie-down hooks, and 6-in. chrome angular step bars (requires PowerScope™ mirrors; SuperCab and Crew Cab only; other restrictions apply)

FX4 OFF-ROAD Package

Includes transfer case and fuel tank skid plates, Hill Descent Control™ (SRW only), Rancho® shocks and FX4 OFF-ROAD box decals (restrictions apply)

Heavy-Service Front Suspension Package

Includes front springs upgrade (unless maximum springs have been computer-selected as included equipment; restrictions apply)

Power Equipment Group

Includes power door locks and front windows (plus rear on Crew Cab) with one-touch-down driver's side window feature, heated sideview mirrors, accessory delay, Remote Keyless Entry System with 2 integrated keyhead transmitter remotes, and perimeter anti-theft alarm

Snow Plow Prep Package

Includes computer-selected springs for snow plow application and extra-heavy-duty alternator with diesel engine only (4x4 only; restrictions apply)

XLT PACKAGES

XLT Appearance Package includes fog lamps, 18-in. cast-aluminum wheels and Chrome Package (SRW SuperCab and Crew Cab only)

XLT Interior Package includes 6-way power driver's seat, power-adjustable pedals, autolamp/rainlamp, autolock, auto-unlock and SecuriCode™ keyless entry keypad

XLT Premium Package includes XLT Interior Package, Chrome Package, SYNC, LCD productivity screen, auto-dimming rearview mirror, compass, fog lamps and steering wheel-mounted audio controls (SRW SuperCab and Crew Cab only)

CLEANEST SUPER DUTY® DIESEL EVER

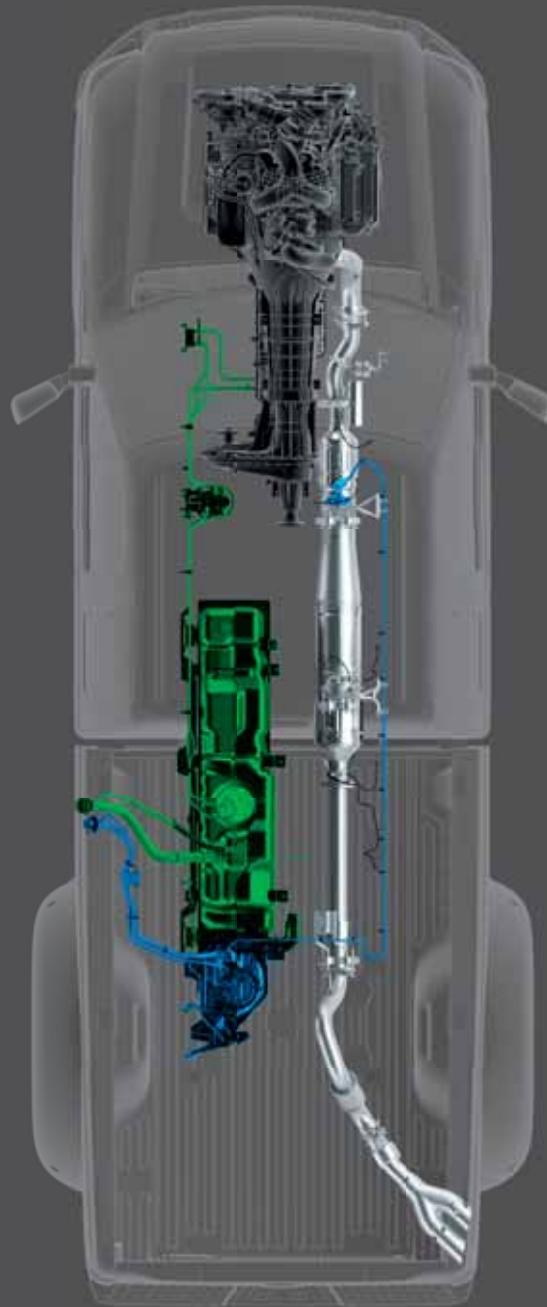

The Ford 6.7L Power Stroke® V8 Turbo Diesel engine uses industry-proven technology and innovative Ford strategies to meet the latest federal emissions standards to reduce nitrogen oxide (NOx) levels by more than 80% compared to previous regulations.

COMBUSTION EFFICIENCY: The process begins in the engine, where combustion is optimized to help reduce emissions from the start.

CLEANING AND HEATING: When the exhaust stream enters the diesel oxidation catalyst (DOC), the hydrocarbons in it are converted and oxidized into water and carbon dioxide. Then things start heating up.

KNOCKING OUT THE NOx: Next, the exhaust stream is dosed with diesel exhaust fluid (DEF), a mixture of urea and water. In the process, the NOx in the exhaust stream is converted into inert nitrogen and water.

SCRUBBING AWAY THE SOOT: Finally, the diesel particulate filter (DPF) traps any remaining soot, which is then periodically burned away.

DOING YOUR PART: The fluid in the 5-gallon DEF reservoir is approximately consumed over the course of each oil change interval. To help make it easy for you to refill, the blue DEF fill cap is located right next to your green diesel fuel cap. The message center alerts you when there's about 800 miles worth of DEF remaining. Ford-approved DEF can be purchased from your Ford Dealer or other authorized retailers.



2011 SUPER DUTY®

ford.com



FORD CUSTOM ACCESSORIES



NEW 5th Wheel Hitch Kit^{1,2}



NEW Gooseneck Hitch Kit²



All-Weather Floor Mats



Soft-Folding Tonneau Cover by Advantage³



Commercial-Grade Tool/Cargo Boxes by Delta³



Splash Guards

Also available:

Appearance

- Chrome Exhaust Tip
- Ford Custom Graphics by Original Wraps,TM Inc.³

Bed Products

- Retractable Stake Pocket Tie-Down by Bull Accessories³
- Bed Mat
- Bedliners
- Bed Tailgate Liner
- Bed Extender
- Sport Liner Carpeted Bed Protection by BedRugTM³
- Soft Roll-Up Tonneau Cover by TruXedo³
- Hard-Folding Tonneau Cover by REV³

Electronics

- Backup Alarm by ECCO³
- Forward or Reverse Bumper-Mounted Parking Assist System by EchoMaster³
- HitchScanTM Rear Park Assist Sensor and Hitch Step by EchoMaster³
- Keyless Entry Keypad
- Portable Navigation Systems by Garmin³
- Remote Start Systems
- GPS Tracking and Recovery by SmartAlertTM³
- Vehicle Security System
- Dual Head Restraint DVD by INVISIONTM³

Exterior

- Retractable Cable Lock by Master Lock³
- Side Window Deflectors
- Chrome Hitch Balls
- Hitch Ball Mounts
- Racks and Carriers by THULE³
- Sportz[®] Tents by Napier³
- Step Bars
- Retractable Rear Step by Bestop³

Interior

- Ashcup/Coin Holder with or without Lighter Element
- Interior Soft Cargo Cooler Bag
- Interior Soft Cargo Organizers (large and standard sizes)
- Leather-Trimmed Interior Seating by Katzkin³
- Protective Seat Covers by Covercraft³

Wheels

- Stainless Steel Wheel Covers by Phoenix³
- Wheel Locks

¹Shown with a spray-in bedliner. ²Only for use with 8-ft. bed. ³Ford Licensed Accessories.

SmartAlert is a registered trademark of Inilex, Inc.
INVISION is a trademark of Audiovox Corporation.
THULE is a registered trademark of Thule Sweden AB.
Katzkin is a registered trademark of Katzkin Leather Inc.

To learn more about Ford Custom Accessories and to buy them online, visit fordaccessories.com.

Genuine Ford Accessories will be warranted for whichever provides you the greatest benefit: 12 months or 12,000 miles (whichever occurs first), or the remainder of your Bumper-to-Bumper 3-year/36,000-mile New Vehicle Limited Warranty. Contact your local Ford Dealer for details and a copy of the limited warranty. Ford Licensed Accessories (FLA) are warranted by the accessory manufacturer's warranty. Ford Licensed Accessories are fully designed and developed by the accessory manufacturer and have not been designed or tested to Ford Motor Company engineering requirements. Contact your Ford Dealer for details regarding the manufacturer's limited warranty and/or a copy of the FLA product limited warranty offered by the accessory manufacturer.



TECHNICAL SPECIFICATIONS

DIMENSIONS

	REGULAR CAB		SUPERCAB		CREW CAB	
	LWB 4x2/4x4	SWB 4x2/4x4	LWB 4x2/4x4	SWB 4x2/4x4	LWB 4x2/4x4	SWB 4x2/4x4
EXTERIOR						
A. Height – F-250 SRW (w/o options)	76.6"/79.2"	77.0"/79.5"	76.9"/79.3"	77.4"/79.7"	77.3"/79.8"	77.2"/80.8"
A. Height – F-350 SRW (w/o options)	76.5"/80.0"	76.9"/80.4"	76.7"/80.2"	77.2"/80.8"	77.2"/80.8"	77.2"/80.8"
A. Height – F-350 DRW (w/o options)	76.7"/79.5"	–	76.9"/79.7"	–	77.3"/79.9"	77.3"/79.9"
A. Height – F-450 DRW (w/o options)	–	–	–	–	79.7"	79.7"
B. Overall width – SRW (excl. mirrors)	79.9"	79.9"	79.9"	79.9"	79.9"	79.9"
B. Overall width – DRW (excl. mirrors)	96.0"	–	96.0"	–	96.0"	96.0"
B. Overall width – With mirrors	104.9"	104.9"	104.9"	104.9"	104.9"	104.9"
B. Overall width – With mirrors extended	110.0"	110.0"	110.0"	110.0"	110.0"	110.0"
C. Ground clearance – F-250 SRW	8.5"/8.2"	8.5"/8.2"	8.5"/8.1"	8.5"/8.1"	8.5"/8.1"	8.5"/8.1"
C. Ground clearance – F-350 SRW	8.5"/8.2"	8.5"/8.2"	8.5"/8.2"	8.5"/8.2"	8.5"/8.2"	8.5"/8.2"
C. Ground clearance – F-350 DRW	8.1"/8.0"	–	8.1"/8.0"	–	8.0"/8.0"	8.0"/8.0"
C. Ground clearance – F-450 DRW	–	–	–	–	8.0"	8.0"
D. Load floor height – F-250 SRW	35.2"/36.3"	34.8"/35.6"	34.4"/35.4"	34.2"/35.1"	34.1"/35.0"	34.1"/35.0"
D. Load floor height – F-350 SRW	34.7"/38.5"	34.4"/37.9"	34.1"/38.0"	33.9"/37.8"	33.8"/37.7"	33.8"/37.7"
D. Load floor height – F-350 DRW	35.0"/36.4"	–	34.3"/35.7"	–	34.1"/35.6"	34.1"/35.6"
D. Load floor height – F-450 DRW	–	–	–	–	35.4"	35.4"
E. Cargo box height	20.0"	20.0"	20.0"	20.0"	20.0"	20.0"
F. Length	227.6"	232.4"	248.6"	246.8"	263.0"	263.0"
G. Overhang – Rear	52.4"	52.4"	52.4"	52.4"	52.4"	52.4"
H. Wheelbase	137.0"	141.8"	158.0"	156.2"	172.4"	172.4"
I. Overhang – Front	38.1"	38.1"	38.1"	38.1"	38.1"	38.1"
J. Angle of departure – F-250 SRW	17.8°/19.2°	17.4°/18.5°	17.0°/18.3°	16.7°/18.0°	16.7°/17.9°	16.7°/17.9°
J. Angle of departure – F-350 SRW	17.3°/21.5°	17.0°/20.9°	16.6°/21.1°	16.4°/20.8°	16.3°/20.8°	16.3°/20.8°
J. Angle of departure – F-350 DRW	17.6°/19.3°	–	16.9°/18.7°	–	16.7°/18.5°	16.7°/18.5°
J. Angle of departure – F-450 DRW	–	–	–	–	18.3°	18.3°
K. Ramp breakover angle – F-250 SRW	17.5°/20.4°	16.9°/19.8°	15.8°/18.1°	15.7°/18.1°	15.0°/17.3°	15.0°/17.3°
K. Ramp breakover angle – F-350 SRW	17.2°/21.5°	16.7°/20.9°	15.6°/19.2°	15.5°/19.2°	14.8°/18.2°	14.8°/18.2°
K. Ramp breakover angle – F-350 DRW	17.5°/20.4°	–	15.9°/18.6°	–	15.0°/17.4°	15.0°/17.4°
K. Ramp breakover angle – F-450 DRW	–	–	–	–	17.0°	17.0°
L. Angle of approach – F-250 SRW	18.0°/19.4°	18.1°/20.1°	18.7°/20.0°	18.7°/20.0°	18.9°/20.6°	18.9°/20.6°
L. Angle of approach – F-350 SRW	18.1°/18.8°	18.2°/19.5°	18.8°/19.3°	18.8°/19.3°	19.0°/20.0°	19.0°/20.0°
L. Angle of approach – F-350 DRW	18.2°/19.2°	–	19.0°/20.6°	–	19.1°/20.3°	19.1°/20.3°
L. Angle of approach – F-450 DRW	–	–	–	–	19.8°	19.8°
INTERIOR						
Front head room	40.7"	40.7"	40.7"	40.7"	40.7"	40.7"
Front shoulder room	68.0"	68.0"	68.0"	68.0"	68.0"	68.0"
Front hip room	67.6"	67.6"	67.6"	67.6"	67.6"	67.6"
Front leg room	41.1"	41.1"	41.1"	41.1"	41.1"	41.1"
Rear head room	–	38.1"	38.1"	40.8"	40.8"	40.8"
Rear shoulder room	–	68.1"	68.1"	68.0"	68.0"	68.0"
Rear hip room	–	67.3"	67.3"	67.6"	67.6"	67.6"
Rear leg room	–	31.6"	31.6"	42.1"	42.1"	42.1"
CARGO BOX						
Volume (cu. ft.)	77.3	64.1	77.3	64.1	77.3	77.3
M. Width at floor (maximum)	69.3"	69.3"	69.3"	69.3"	69.3"	69.3"
N. Length at floor	98.0"	81.8"	98.0"	81.8"	98.0"	98.0"
O. Width at wheelhouse	50.9"	50.9"	50.9"	50.9"	50.9"	50.9"

SRW = single rear wheel DRW = dual rear wheel SWB = short wheelbase (6¾' cargo box) LWB = long wheelbase (8' cargo box)

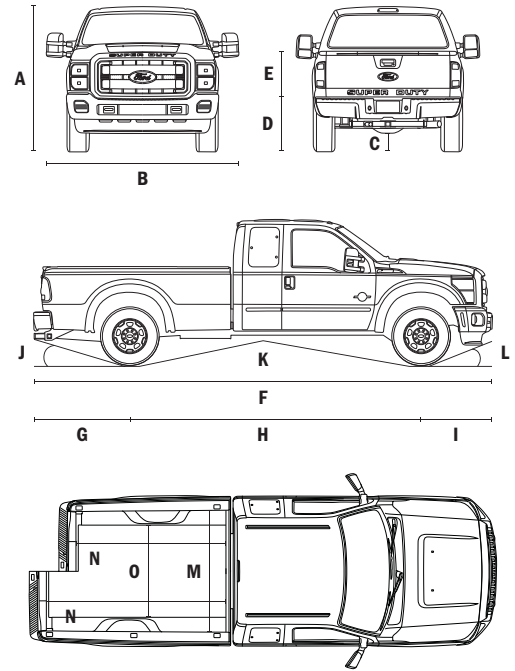

INTERIOR STORAGE (cu. ft.)

Front 40/20/40 split seat center under-seat lockable storage	0.36
Front flow-through center console main bin	1.23
Rear Crew Cab 60/40 split bench lockable under-seat storage	1.17

TRANSMISSION

Type	6-speed SelectShift Automatic™	
Case material	Aluminum	
PTO	Live-drive access on driver's side (diesel only)	
Gear ratios	1st	3.97:1
	2nd	2.32:1
	3rd	1.52:1
	4th	1.15:1
	5th	0.86:1
	6th	0.67:1
	Reverse	3.13:1

CONVENTIONAL TOWING – MAXIMUM LOADED TRAILER WEIGHT RATINGS (LBS.)

ENGINE	AXLE RATIO	GCWR (LBS.)	REGULAR CAB					SUPERCAB					CREW CAB						
			F-250/ F-350 SRW 4x2	F-350 DRW 4x2	F-250 SRW 4x4	F-350 SRW 4x4	F-350 DRW 4x4	F-250/ F-350 SRW 4x2	F-350 DRW 4x2	F-250 SRW 4x4	F-350 SRW 4x4	F-350 DRW 4x4	F-250 SRW 4x2	F-350 SRW 4x2	F-350 DRW 4x2	F-250 SRW 4x4	F-350 SRW 4x4	F-350 DRW 4x4	
6.2L 2-valve FFV	3.73	19,000	12,500	–	12,400	12,400	–	12,500	–	12,200	12,100	–	12,400	12,300	–	12,000	11,900	–	–
		19,500	–	12,900	–	12,400	–	12,500	–	12,500	–	12,100	–	12,300	–	–	11,800	–	–
	4.30	22,000	12,500	–	12,500	12,500	–	12,500	–	12,500	12,500	–	12,500	12,500	–	12,500	12,500	–	–
		22,500	–	15,000	–	15,000	–	15,000	–	15,000	–	15,000	–	15,000	–	15,000	–	14,800	–
6.7L V8 Turbo Diesel	3.31	23,500	12,500	–	12,500	12,500	–	14,000	–	14,000	14,000	–	14,000	14,000	–	14,000	14,000	–	–
		23,500	12,500	–	12,500	12,500	–	14,000	–	14,000	14,000	–	14,000	14,000	–	14,000	14,000	–	–
	4.30	30,000	–	15,000	–	–	15,000	–	15,000	–	–	15,000	–	–	–	17,500 ¹	–	–	17,500 ¹
		33,000	–	–	–	–	–	–	–	–	–	–	–	–	–	–	–	–	17,500 ¹

¹Available early 2011.

2011 SUPER DUTY®

ford.com



POWERTRAINS

	6.2L 2-VALVE GAS ¹	6.7L V8 TURBO DIESEL
Configuration	SOHC	OHV (32-valve)
Fuel injection	Sequential Electronic	High-Pressure Common-Rail
Engine control system	Electronic	Electronic
Induction system	Specially tuned	Single-Sequential Turbocharger; charged air cooler
Battery	12-volt; 650-cca/72-amp-hr	Dual 12-volt; 750-cca/78-amp-hr
Alternator	157-amp	157-amp (Single 200-amp or dual combined 357-amp, optional)
Cooling system	Pressurized series flow	Pressurized series flow
Oil-life monitor	Oil-minder system	Intelligent Oil-Life Monitor™
Cylinders	8	8
Cylinder head	Aluminum	Aluminum
Block material	Cast iron	Compacted graphite iron
Valve operation	Roller rocker shaft	Push rod/rocker arms
Camshaft drive	Silent chain	Gear
Bore/Stroke	4.02"/3.74"	3.90"/4.25"
Compression ratio	9.8:1	16.2:1
Horsepower/rpm	385 @ 5,500 ² /316 @ 4,179 ³	400 @ 2800
Torque lb.-ft./rpm	405 @ 4,500 ² /397 @ 4,179 ³	800 @ 1600
Recommended fuel	Regular unleaded or E85	Ultra-Low-Sulfur Diesel or B20 (containing 20% or less biodiesel)

¹Certified to SAE J1349. ²Under 10K GVWR. ³Over 10K GVWR.

MECHANICAL

FRONT SUSPENSION

Type	Twin-I-Beam (F-250/F-350 4x2); solid Twin-Coil Monobeam axle (F-250/F-350 4x4, F-450 4x2 and 4x4)
Axle (rating @ ground)	5,250 lbs. (F-250/F-350 4x2); 6,000 lbs. (F-250/F-350/F-450 4x4)
Springs	Coil
Shock absorbers	1.38" gas type
Stabilizer bar	Standard

REAR SUSPENSION

Type	Solid axle
Axle (rating @ ground)	6,200 lbs. (F-250); 7,280 lbs. (F-350 SRW); 9,500 lbs. (F-350 DRW); 9,500 lbs. (F-450)
Springs	Leaf
Shock absorbers	1.38" gas type
Stabilizer bar	Standard on DRW pickup; optional in package on SRW pickup

STEERING

Assist	Power
Overall ratio	20.49:1 (F-250/F-350 4x2); 20.41:1 (F-250/F-350 4x4); 20.41:1 average (F-450)

BRAKES

Type	4-wheel vented-disc ABS (standard)
Front (rotor diameter)	13.66" (F-250/F-350); 14.53" (F-450)
Rear (rotor diameter)	13.39" (F-250/F-350); 15.35" (F-450)

WHEELS

Type	Steel or aluminum
Size	17," 18" or 20" (F-250/F-350); 17" (F-450)
Number of studs	8
Bolt-circle diameter	6.7" (170-mm) SRW; 7.87" (200-mm) F-350 DRW; 7.87" (200-mm) F-450

5TH-WHEEL TOWING — MAXIMUM LOADED TRAILER WEIGHT RATINGS (LBS.)

ENGINE	AXLE RATIO	GCWR (LBS.)	REGULAR CAB						SUPERCAB						CREW CAB							
			F-250 SRW 4x2	F-350 SRW 4x2	F-350 DRW 4x2	F-250 SRW 4x4	F-350 SRW 4x4	F-350 DRW 4x4	F-250 SRW 4x2	F-350 SRW 4x2	F-350 DRW 4x2	F-250 SRW 4x4	F-350 SRW 4x4	F-350 DRW 4x4	F-250 SRW 4x2	F-350 SRW 4x2	F-350 DRW 4x2	F-250 SRW 4x4	F-350 SRW 4x4	F-350 DRW 4x4	F-450 DRW 4x4	
6.2L 2-valve FFV	3.73	19,000	12,700	12,600	—	12,200	12,100	—	12,400	12,300	—	11,900	11,900	—	12,100	12,100	—	11,700	11,700	—	—	—
	4.30	19,500	—	12,700	—	—	12,200	—	—	—	12,300	—	—	11,800	—	12,000	—	—	—	11,600	—	
		22,000	15,700	15,600	—	15,200	15,100	—	15,400	15,300	—	14,900	14,900	—	15,100	15,100	—	14,700	14,700	—	—	—
6.7L V8 Turbo Diesel	3.31	23,500	16,500	16,500	—	16,100	16,000	—	16,200	16,300	—	15,700	15,700	—	16,000	16,000	—	14,300	15,600	—	—	—
		33,000	—	—	—	—	—	—	—	—	—	—	—	—	—	—	—	—	—	—	—	—
	3.55	23,500	16,500	16,500	—	16,100	16,000	—	16,200	16,300	—	15,700	15,700	—	16,000	16,000	—	14,300	15,600	—	—	—
	3.73	30,000	—	—	22,600	—	—	22,100	—	—	—	22,000	—	—	—	—	21,800	—	—	21,300	—	—
4.30	33,000	—	—	—	—	—	—	—	—	—	—	—	—	—	—	—	—	—	—	—	24,400	

MAXIMUM PAYLOAD WEIGHT RATINGS (LBS.)

	MAX. GVWR (LBS.)	REGULAR CAB		SUPERCAB		CREW CAB	
		137.0" WB	141.1" WB	158.0" WB	156.2" WB	172.4" WB	
F-250 SRW 4x2	9,800	4,080	—	—	—	—	—
	9,900	—	3,790	—	—	—	—
	10,000	3,560	3,220	3,800	3,660	3,550	—
F-250 SRW 4x4	10,000	3,760	3,460	3,350	3,250	3,140	—
F-350 SRW 4x2	10,500	4,600	4,270	—	—	—	—
	10,700	—	—	—	4,260	—	—
	10,900	—	—	4,590	—	—	—
	11,000	4,450	4,110	—	—	4,430	—
	11,400	—	—	—	—	4,350	—
F-350 SRW 4x4	11,500	—	—	4,470	—	4,260	—
	11,000	—	—	4,230	—	—	—
	11,100	4,670	4,430	—	—	—	—
	11,200	—	—	—	—	4,220	—
	11,300	—	—	—	—	4,420	—
11,500	4,500	4,180	4,040	3,990	3,770	—	
F-350 DRW 4x2	13,300	7,070	—	6,640	—	6,400	—
F-350 DRW 4x4	13,300	6,580	—	6,190	—	5,970	—
F-450 DRW 4x4	13,300	—	—	—	—	5,200	—

WB = wheelbase

2011 SUPER DUTY®

ford.com

